D9010USBC USB 2.0 Compliance Test Application

Notices

© Keysight Technologies 2024

No part of this manual may be reproduced in any form or by any means (including electronic storage and retrieval or translation into a foreign language) without prior agreement and written consent from Keysight Technologies as governed by United States and international copyright laws.

Trademarks

UNIX is a registered trademark of UNIX System Laboratories in the U.S.A. and other countries. Target is copyrighted by Thru-Put Systems, Inc.

Version

Version 4.21.0.0

Edition

May 2024

Available in electronic format only

Keysight Technologies, Inc.
1900 Garden of the Gods Road
Colorado Springs, CO 80907 USA

Warranty

THE MATERIAL CONTAINED IN THIS DOCUMENT IS PROVIDED "AS IS," AND IS SUBJECT TO BEING CHANGED, WITHOUT NOTICE, IN FUTURE EDITIONS. FURTHER, TO THE MAXIMUM EXTENT PERMITTED BY APPLICABLE LAW, KEYSIGHT DISCLAIMS ALL WARRANTIES, EITHER EXPRESS OR IMPLIED WITH REGARD TO THIS MANUAL AND ANY INFORMATION CONTAINED HEREIN, INCLUDING BUT NOT LIMITED TO THE IMPLIED WARRANTIES OF MERCHANTABILITY AND FITNESS FOR A PARTICULAR PURPOSE. KEYSIGHT SHALL NOT BE LIABLE FOR ERRORS OR FOR INCIDENTAL OR CONSEQUENTIAL DAMAGES IN CONNECTION WITH THE FURNISHING, USE, OR PERFORMANCE OF THIS DOCUMENT OR ANY INFORMATION CONTAINED HEREIN. SHOULD KEYSIGHT AND THE USER HAVE A SEPARATE WRITTEN AGREEMENT WITH WARRANTY TERMS COVERING THE MATERIAL IN THIS DOCUMENT THAT CONFLICT WITH THESE

TERMS, THE WARRANTY TERMS IN THE SEPARATE AGREEMENT WILL CONTROL.

Technology Licenses

The hardware and/or software described in this document are furnished under a license and may be used or copied only in accordance with the terms of such license.

U.S. Government Rights

The Software is "commercial computer software," as defined by Federal Acquisition Regulation ("FAR") 2.101. Pursuant to FAR 12.212 and 27.405-3 and Department of Defense FAR Supplement ("DFARS") 227.7202, the U.S. government acquires commercial computer software under the same terms by which the software is customarily provided to the public. Accordingly, Keysight provides the Software to U.S. government customers under its standard commercial license, which is embodied in its End User License Agreement (EULA), a copy of which can be found at <http://www.keysight.com/find/sweula>. The license set forth in the EULA represents the exclusive authority by which the U.S. government may use, modify, distribute, or disclose the Software. The EULA and the license set forth therein, does not require or permit, among other things, that Keysight: (1) Furnish technical information related to commercial computer software or commercial computer software documentation that is not customarily provided to the public; or (2) Relinquish to, or otherwise provide, the government rights in excess of these rights customarily provided to the public to use, modify, reproduce, release, perform, display, or disclose commercial computer software or commercial computer software documentation. No additional government requirements beyond those set forth in the EULA shall apply, except to the extent that those terms, rights, or licenses are explicitly required from all providers of commercial computer software pursuant to the FAR and the DFARS and are set forth specifically in writing elsewhere in the EULA. Keysight shall be under no obligation to update, revise or otherwise modify the Software. With respect to any technical data as defined by FAR 2.101, pursuant to FAR 12.211 and 27.404.2 and DFARS 227.7102, the U.S. government acquires no

greater than Limited Rights as defined in FAR 27.401 or DFAR 227.7103-5 (c), as applicable in any technical data.

Safety Notices

CAUTION

A CAUTION notice denotes a hazard. It calls attention to an operating procedure, practice, or the like that, if not correctly performed or adhered to, could result in damage to the product or loss of important data. Do not proceed beyond a CAUTION notice until the indicated conditions are fully understood and met.

WARNING

A WARNING notice denotes a hazard. It calls attention to an operating procedure, practice, or the like that, if not correctly performed or adhered to, could result in personal injury or death. Do not proceed beyond a WARNING notice until the indicated conditions are fully understood and met.

USB Automated Testing—At A Glance

The Keysight D9010USBC USB 2.0 compliance test option helps you verify USB compliance to specifications using the Keysight 9000A, S-Series, 90000A, MXR, or UXR Series Infiniium digital storage oscilloscope.

The USB 2.0 compliance test option runs under an automated test engine that.

- Lets you select individual or multiple tests to run.
- Lets you identify the device being tested and its configuration.
- Shows you how to make oscilloscope connections to the device under test.
- Automatically checks for proper oscilloscope configuration.
- Automatically sets up the oscilloscope for each test.
- Provides detailed information for each test that has been run and lets you specify the thresholds at which marginal or critical warnings appear.
- Creates a printable HTML report of the tests that have been run.

In This Book

This manual contains notes on the electrical tests that are performed by the USB 2.0 compliance test option; it describes the equipment used, and it describes how the tests are performed.

- **Chapter 1**, “Installing the USB 2.0 Compliance Test Application” shows how to install and license the automated test application software (if it was purchased separately).
- **Chapter 2**, “Preparing to Take Measurements” describes the equipment required, how to set up the equipment, how to start the USB 2.0 Compliance Test Option, and how to run tests.
- **Chapter 3**, “Device Hi-Speed Tests” describes the equipment used for each test setup.
- **Chapter 4**, “Hub Hi-Speed Tests” describes the equipment used for each test setup.
- **Chapter 5**, “Host Hi-Speed Electrical Tests” describes the equipment used for each test setup.
- **Chapter 6**, “Troubleshooting Hi-Speed Test Failures” describes the Debug Mode options that can be used when troubleshooting hi-speed test failures.
- **Chapter 7**, “Low and Full Speed Tests” describes the equipment used for each test setup.
- **Chapter 8**, “Embedded Host Hi-Speed Tests” describes the equipment used each test setup.
- **Chapter 9**, “Manual Testing and Measurement Using Oscilloscope” describes the steps used for manual testing.

See Also

- The USB 2.0 Compliance Test Option’s online help, which describes: creating or opening a test project, selecting tests, configuring selected tests, connecting the oscilloscope to the DUT, running tests, viewing test results, and viewing/printing the HTML test report.”

Saving test projects.

- The USB 2.0 developers documents are available at the USB Implementers Forum web site, <http://www.usb.org/developers/docs>. This web page has test procedure documents for the D9010USBC USB 2.0 Compliance Test Option, which contain test records used for compliance test submission.

Contents

USB Automated Testing—At A Glance 4

In This Book 5

1 Installing the USB 2.0 Compliance Test Application

Installing the Software 18

Installing the License Key 19

Using Keysight License Manager 5 19

Using Keysight License Manager 6 20

2 Preparing to Take Measurements

Required Equipment and Software 24

Oscilloscope, Software, and Accessories 24

High-Speed Electrical Test Bed Computer 27

E2649B USB 2.0 High-Speed Fixture Set 27

Setting Up the Equipment 30

Infiniium S-Series, 9000A, 90000A, MXR, or UXR Series Digital Sampling Oscilloscope 30

Differential Connection 30

Single-Ended Connection 31

81160A Digital Signal Generator 31

Starting the USB 2.0 Compliance Test Application 32

Online Help Topics 34

Running Tests 35

3 Device Hi-Speed Tests

Device Hi-Speed Signal Quality Test 39

Equipment Used 39

Selecting the Tests 39

Configuring the Tests 40

Connecting the Equipment - Differential Connection 41

Connecting the Equipment - Single-Ended Connection 42

Running the Tests 43

Test Instructions, Part 1 43

Test Instructions, Part 2 44

Viewing Test Results 45

Device Packet Parameters	46
Equipment Used	46
Selecting the Tests	46
Connecting the Equipment - Single-Ended Connection	48
Connecting the Equipment - Differential Connection	49
Running the Tests	50
Test Instructions, Part 1	50
Test Instructions, Part 2	50
Viewing Test Results	52
Device CHIRP Timing	53
Equipment Used	53
Selecting the Tests	53
Configuring the Tests	54
Connecting the Equipment	54
Running the Tests	55
Test Instructions	55
Viewing Test Results	55
Device Suspend/Resume/Reset Timing	56
Equipment Used	56
Selecting the Tests	56
Configuring the Tests	57
Connecting the Equipment	57
Running the Tests	58
Test Instructions	58
Viewing Test Results	63
Device Test J/K, SEO_NAK	64
Equipment Used	64
Selecting the Tests	64
Configuring the Tests	65
Connecting the Equipment (Using Probe)	65
Connecting the Equipment (Using Voltmeter)	66
Running the Tests	66
Test Instructions	66
Viewing Test Results	69
Device Receiver Sensitivity	70
Equipment Used	70
Selecting the Tests	71
Configuring the Tests	71
Connecting the Equipment	72
Running the Tests	73
Test Instructions	73
Viewing Test Results	74

4 Hub Hi-Speed Tests

Hub Hi-Speed Signal Quality Test - Upstream Facing Ports	77
Equipment Used	77
Selecting the Tests	78
Configuring the Tests	78
Connecting the Equipment - Differential Connection	78
Connecting the Equipment - Single-Ended Connection.	79
Running the Tests	80
Test Instructions, Part 1	80
Test Instructions, Part 2	81
Viewing Test Results	82
Hub Hi-Speed Signal Quality Test - Downstream Facing Ports	83
Equipment Used	83
Selecting the Tests	83
Configuring the Tests	84
Connecting the Equipment - Differential Connection	84
Connecting the Equipment - SingleEnded Connection	85
Running the Tests	85
Test Instructions	85
Viewing Test Results	86
Hub Jitter Test - Downstream Facing Ports	87
Equipment Used	87
Selecting the Tests	87
Configuring the Tests	88
Connecting the Equipment - Differential Connection	88
Connecting the Equipment - SingleEnded Connection	89
Running the Tests	89
Test Instructions	89
Viewing Test Results	91
Hub Packet Parameters - Upstream Facing Port	92
Equipment Used	92
Selecting the Tests	92
Configuring the Tests	93
Connecting the Equipment - Differential Connection	93
Connecting the Equipment - Single-Ended Connection	94
Running the Tests	94
Test Instructions, Part 1	94
Test Instructions, Part 2	96
Viewing Test Results	98

Hub Packet Parameters - Downstream Facing Port	99
Equipment Used	99
Selecting the Tests	99
Configuring the Tests	100
Connecting the Equipment - Differential Connection	100
Connecting the Equipment - Single-Ended Connection	100
Running the Tests	102
Test Instructions, Part 1	102
Test Instructions, Part 2	103
Hub Receiver Sensitivity - Upstream Facing Port	105
Equipment Used	105
Selecting the Tests	106
Configuring the Tests	107
Connecting the Equipment	111
Running the Tests	113
Test Instructions	113
Viewing Test Results	114
Hub Repeater Test - Downstream Facing Port	115
Equipment Used	115
Selecting the Tests	115
Configuring the Tests	116
Connecting the Equipment	116
Running the Tests	117
Test Instructions	117
Viewing Test Results	118
Hub Repeater Test - Upstream Facing Port	119
Equipment Used	119
Selecting the Tests	120
Configuring the Tests	120
Connecting the Equipment	120
Running the Tests	121
Test Instructions, Part 1	121
Test Instructions, Part 2	122
Viewing Test Results	123
Hub CHIRP Timing - Upstream Facing Port	124
Equipment Used	124
Selecting the Tests	125
Configuring the Tests	125
Connecting the Equipment	125
Running the Tests	127
Test Instructions	127
Viewing Test Results	127

Hub Suspend/Resume/Reset Timing - Upstream Facing Port	128
Equipment Used	128
Selecting the Tests	128
Configuring the Tests	129
Connecting the Equipment	129
Running the Tests	130
Test Instructions	130
Viewing Test Results	134
Hub Test J/K, SEO_NAK - Upstream Facing Port	135
Equipment Used	135
Selecting the Tests	135
Configuring the Tests	136
Connecting the Equipment (Using Probe)	136
Connecting the Equipment (Using Voltmeter)	137
Running the Tests	138
Test Instructions	138
Viewing Test Results	141
Hub Test J/K, SEO_NAK - Downstream Facing Port	142
Equipment Used	142
Selecting the Tests	142
Configuring the Tests	143
Connecting the Equipment (Using Probes)	143
Connecting the Equipment (Using Voltmeter)	144
Running the Tests	145
Viewing Test Results	147

5 Host Hi-Speed Electrical Tests

Host Hi-Speed Signal Quality	151
Equipment Used	151
Selecting the Tests	151
Configuring the Tests	152
Connecting the Equipment - Differential Connection	152
Connecting the Equipment - Single-Ended Connection	153
Running the Tests	155
Test Instructions, Part 1	155
Test Instructions, Part 2	155
Viewing Test Results	156

Host Controller Packet Parameters	157
Equipment Used	157
Selecting the Tests	157
Configuring the Tests	159
Connecting the Equipment - Differential Connection	159
Connecting the Equipment - Single-Ended Connection	160
Running the Tests	161
Test Instructions, Part 1	161
Test Instructions, Part 2	161
Viewing Test Results	164
Host CHIRP Timing	165
Equipment Used	165
Selecting the Tests	165
Configuring the Tests	166
Connecting the Equipment	166
Running the Tests	167
Test Instructions	167
Viewing Test Results	168
Host Suspend/Resume Timing	169
Equipment Used	169
Selecting the Tests	169
Configuring the Tests	170
Connecting the Equipment	170
Running the Tests	171
Test Instructions	171
Viewing Test Results	173
Host Test J/K, SEO_NAK	174
Equipment Used	174
Selecting the Tests	174
Configuring the Tests	175
Connecting the Equipment (Using Probes)	175
Connecting the Equipment (Using Voltmeter)	176
Running the Tests	177
Test Instructions	177
Viewing Test Results	179

6 Troubleshooting Hi-Speed Test Failures

7 Low and Full Speed Tests

Droop/Drop Test	184
------------------------	-----

Inrush Current Test	187
Equipment Used	187
Selecting the Tests	187
Configuring the Tests	188
Connecting the Equipment	188
Running the Tests	189
Test Instructions, Part 1	189
Test Instructions, Part 2	190
Viewing Test Results	190
Signal Integrity Test	191
Host Low Speed Signal Quality Test	191
Host Full Speed Signal Quality Test	194
Hub Low Speed Signal Quality Test	197
Hub Downstream Full Speed Signal Quality Test	200
Upstream Signal Quality Test	203
Back-Voltage Test Before Enumerate	213
Equipment Used	213
Selecting the Tests	213
Configuring the Tests	214
Connecting the Equipment	214
Running the Tests	214
Test Instructions	214
Viewing Test Results	215
Back-Voltage Test After Enumerate	216
Equipment Used	216
Selecting the Tests	216
Configuring the Tests	217
Connecting the Equipment	217
Running the Tests	218
Test Instructions	218
Viewing Test Results	218
8 Embedded Host Hi-Speed Tests	
Embedded Host Hi-Speed Signal Quality Test	220
Equipment Used	220
Selecting the Tests	221
Configuring the Tests	222
Connecting the Equipment - Single-Ended Connection	222
Connecting the Equipment - Differential Connection	223
Running the Tests	224
Test Instructions	224
Viewing Test Results	225

Embedded Host Controller Packet Parameters	226
Equipment Used	226
Selecting the Tests	226
Configuring the Tests	227
Connecting the Equipment	227
Running the Tests	229
Test Instructions, Part 1	229
Test Instructions, Part 2	230
Connecting the Equipment	230
Test Instructions, Part 1	230
Viewing Test Results	231
Host CHIRP Timing	232
Equipment Used	232
Selecting the Tests	232
Configuring the Tests	233
Connecting the Equipment	233
Running the Tests	234
Test Instructions	235
Viewing Test Results	235
Host Suspend/Resume Timing	236
Equipment Used	236
Selecting the Tests	236
Configuring the Tests	236
Connecting the Equipment	237
Running the Tests	239
Test Instructions	239
Viewing Test Results	240
Host Test J/K, SEO_NAK	241
Equipment Used	241
Selecting the Tests	241
Configuring the Tests	242
Connecting the Equipment (Using Probes)	242
Connecting the Equipment (Using Voltmeter)	243
Running the Tests	244
Test Instructions	244
Viewing Test Results	246

9 Manual Testing and Measurement Using Oscilloscope

Device/Hub/Host Signal Quality Measurement	248
Measurement	248

Packet Parameter Scope Setup for Device/Hub/Host	249
Measurement	249
Chirp Timing Setup	253
Chirp Measurement	253
Device/Hub/Host Suspend Timing	257
Suspend Timing Measurement	257
Device/Hub/Host Resume Timing	258
Resume Timing Measurement	258
Device Reset Timing	259
Device/Hub Reset Timing Measurement	259
Device/Hub Reset from Suspend Timing	260
Measurement	260
Device/Hub Receiver Sensitivity	261
Receiver Sensitivity Measurement	261
Hub Repeater Test – Downstream Facing Ports (EL_42, EL_43, EL_44, EL_45, EL_48)	265
Hub Repeater Test – Upstream Facing Port (EL_42, EL_43, EL_44, EL_45)	267
Upstream Full Speed Measurement	270
Upstream Low Speed Measurement	271
Downstream Full Speed Test	272
Downstream Low Speed	273
Inrush Current	274
Drop Test	275
Droop Test	276

Index

1 Installing the USB 2.0 Compliance Test Application

Installing the Software 18
Installing the License Key 19

If you purchased the D9010USBC USB 2.0 Compliance Test Application separately, you need to install the software and license key.

Installing the Software

- 1 Make sure you have the minimum required version of Infiniium Oscilloscope software (see the D9010USBC USB 2.0 Compliance Test Application release notes). To check the currently installed version, select **Help > About Infiniium...** from the main menu.
- 2 Download the latest version of the D9010USBC USB 2.0 Compliance Test Application software to your oscilloscope:
 - a Go to: <http://www.keysight.com/find/D9010USBC>
 - b Click the D9010USBC USB 2.0 Compliance Test Application links.
- 3 Run the setup program, and follow the instructions.

Be sure to accept the installation of the .NET Framework software; it is required in order to run the USB 2.0 Compliance Test Application.

Installing the License Key

To procure a license, you require the Host ID information that is displayed in the Keysight License Manager application installed on the same machine where you wish to install the license.

Using Keysight License Manager 5

To view and copy the Host ID from Keysight License Manager 5:

- 1 Launch Keysight License Manager on your machine, where you wish to run the Test Application and its features.
- 2 Copy the Host ID that appears on the top pane of the application. Note that x indicates numeric values.

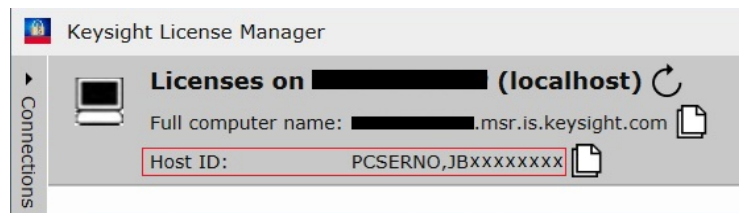

Figure 1 Viewing the Host ID information in Keysight License Manager 5

To install one of the procured licenses using Keysight License Manager 5 application,

- 1 Save the license files on the machine, where you wish to run the Test Application and its features.
- 2 Launch Keysight License Manager.
- 3 From the configuration menu, use one of the options to install each license file.

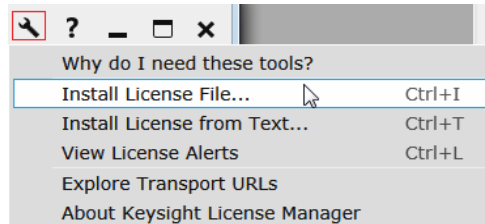

Figure 2 Configuration menu options to install licenses on Keysight License Manager 5

For more information regarding installation of procured licenses on Keysight License Manager 5, refer to [Keysight License Manager 5 Supporting Documentation](#).

Using Keysight License Manager 6

To view and copy the Host ID from Keysight License Manager 6:

- 1 Launch Keysight License Manager 6 on your machine, where you wish to run the Test Application and its features.
- 2 Copy the Host ID, which is the first set of alphanumeric value (as highlighted in Figure 3) that appears in the Environment tab of the application. Note that x indicates numeric values.

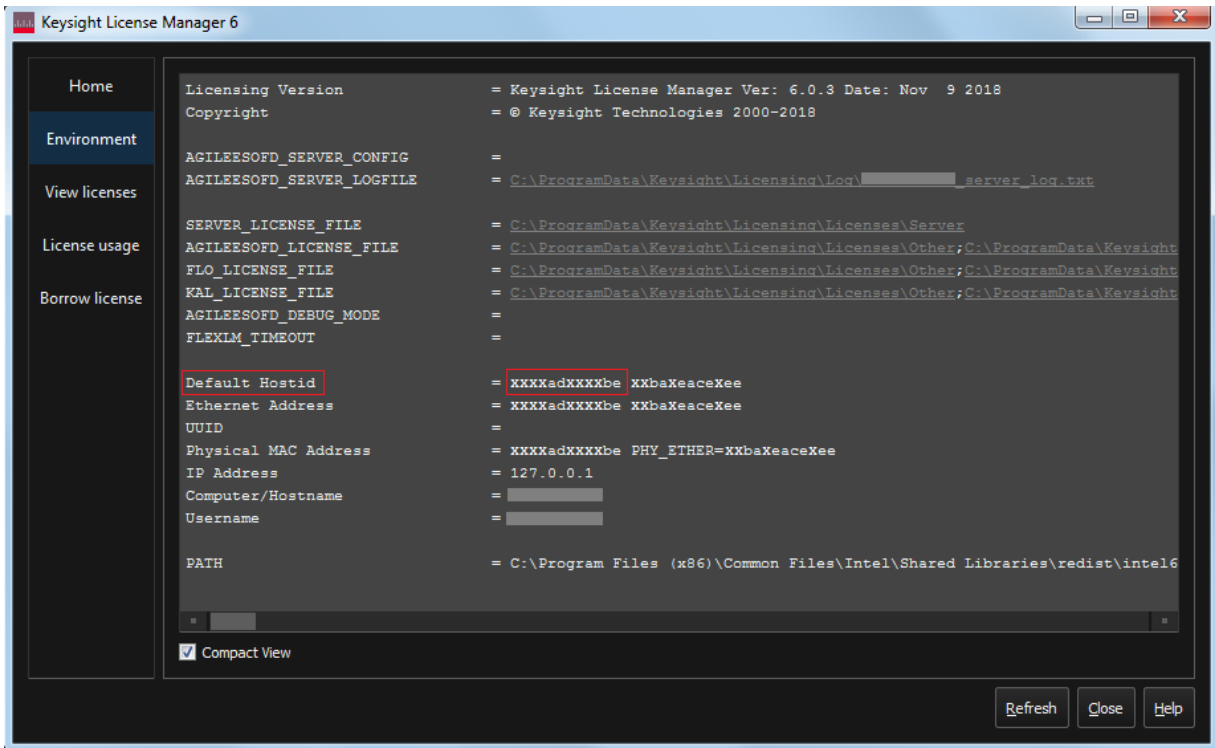

Figure 3 Viewing the Host ID information in Keysight License Manager 6

To install one of the procured licenses using Keysight License Manager 6 application,

- 1 Save the license files on the machine, where you wish to run the Test Application and its features.
- 2 Launch Keysight License Manager 6.
- 3 From the Home tab, use one of the options to install each license file.

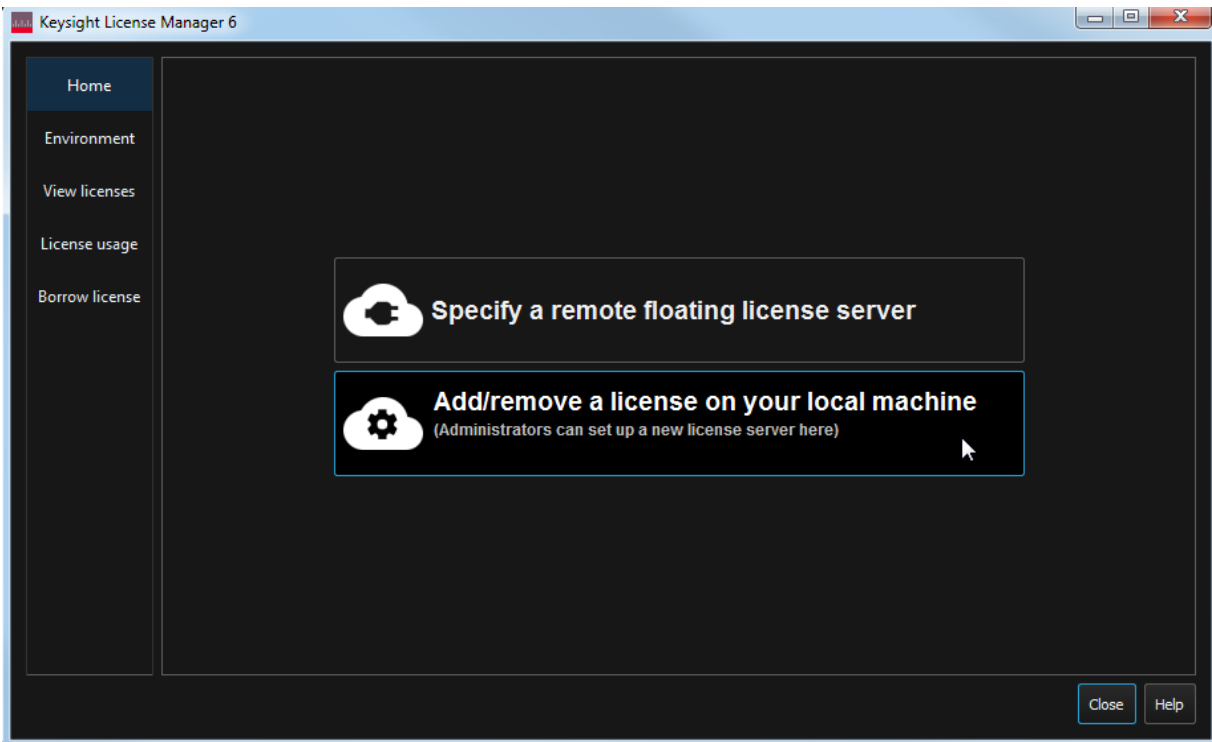

Figure 4 Home menu options to install licenses on Keysight License Manager 6

For more information regarding installation of procured licenses on Keysight License Manager 6, refer to [Keysight License Manager 6 Supporting Documentation](#).

1 Installing the USB 2.0 Compliance Test Application

2 Preparing to Take Measurements

Required Equipment and Software	24
Setting Up the Equipment	30
Starting the USB 2.0 Compliance Test Application	32
Running Tests	35

This chapter lists all of the required equipment for running the compliance tests. It also includes information on the fundamental equipment connections, accessing help, and running the software. After you gather and set up the required equipment and software, you can start the USB 2.0 Compliance Test Application and begin performing the electrical compliance tests.

Required Equipment and Software

The following tables list the required test equipment and the tests for which they are required.

Oscilloscope, Software, and Accessories

Table 1 Digital Storage Oscilloscope, Software, and Accessories

Equipment Required	TESTS			
	Host Hi-Speed	Hub Hi-Speed	Device Hi-Speed	Low/Full Speed
Keysight S-Series, 9000A, 90000A, UXR, or MXR Series Infiniium oscilloscope; In MXR, only channels 1-4 are supported and pairing of channels 1-3 and 2-4 is allowed.	1*	1 ^{a,b}	1 ^{a,b}	1 ^{a,b}
Keysight D9010USBC USB Compliance Test Option.	1	1	1	1
Computer monitor (optional).	optional	optional	optional	optional
Keysight 1131B, 1134B InfiniiumMax differential probe.	1	2	1	n/a
Keysight E2669B differential connectivity kit, OR E2678B socketed head.	1	2	1	n/a
Keysight header adapter (P/N 01131-68703), included with E2669B and E2678BB purchased after October, 2003.	1 [†]	2 ^c	1 ^c	n/a
Keysight E2697A 1 MOhm adapter with passive probe, OR 1130A, 1130B, N2751A, N2796A, 1132B or 1132B active probe.	2	2	2	3 [‡]
Keysight E2697A high impedance converter, N2782B current probe, and N2779A power supply.	n/a	n/a	n/a	1 ^d
Keysight 8710-2063 dual lead adapter (3 units) - to be used with the 10073D passive probe				

* The oscilloscope's memory upgrade option is recommended (Option 001 when ordered with the oscilloscope, or after purchase: N5472A for the 90000A Series oscilloscopes). This gives the automated test software more flexibility in making corner case measurements (and improves test performance).

† For low/full speed testing, the Keysight Infiniium S-Series oscilloscope with N2873A passive probe and 1147B current probe can be used instead.

‡ The header adapter is not needed with hi-speed test fixtures (E2666B through E2646B).

Table 2 Digital Multimeter

Equipment Required	TESTS			
	Host Hi-Speed	Hub Hi-Speed	Device Hi-Speed	Low/Full Speed
Keysight 33461A digital multimeter or equivalent.	1	1	1	1
Mini-clip DMM leads - one each of black and red color.	1	1	1	1

Table 3 Digital Signal Generator

Equipment Required	TESTS			
	Host Hi-Speed	Hub Hi-Speed	Device Hi-Speed	Low/Full Speed
Keysight 81160A Pulse/Pattern Generator with 2 channels of Keysight 81132B (660 MHz) option.	n/a	1	1	n/a
1 MB Memory card option for 81160A (option UFJ).	n/a	1	1	n/a
6dB attenuator (Keysight 8493C Option 006) - for scaling the DSG output voltages needed for receiver sensitivity test.	n/a	2	2	n/a
50-ohm coaxial cable with male SMA connectors at both ends (Keysight 8120-4948 or equivalent).	n/a	2	2	n/a
Keysight 82357B USB/GPIB interface	n/a	1	1	n/a

Table 4 Miscellaneous Cables and Devices

Equipment Required	TESTS			
	Host Hi-Speed	Hub Hi-Speed	Device Hi-Speed	Low/Full Speed
5 m USB cable (any listed on USB-IF web site).	1	1	1	as needed
1.5 m USB cable (any listed on USB-IF web site).	1	1	n/a	n/a
1 m USB cable (any listed on USB-IF web site).				as needed
Modular AC power cord.	2	2	2	
Hi-Speed USB Hub (any listed on USB-IF web site).	1	n/a	n/a	
Hi-Speed USB Device (any listed on USB-IF web site).	1	n/a	n/a	
USB self-powered hub (and power supply). These are the hubs used for compliance testing and are available from the USB-IF. For development testing, in most cases, a hub that has passed USB compliance testing can be used.	n/a	n/a	n/a	5

Table 5 Oscilloscope - Supported Probe/Adapter Mapping Table

Scope Family	Probe input type	Input Impedance	Adapters Needed for Passive Probes	Adapters Needed for Auto Probe 1 Active Probes	Adapters Needed for Auto Probe 2 Active Probes
9000A/H, S, MXR, EXR	Auto Probe 1	50 Ω & 1 M Ω	No	No	Not Possible
90000A	Auto Probe 1	50 Ω	E2697A (discontinued)	No	Not Possible
X90000A/Q,V,Z	Auto Probe 2	50 Ω	N5449A	N5442A	No
UXR with Auto Probe 2	Auto Probe 2	50 Ω	N5449A	N5442A	No
UXR with Auto Probe 3	Auto Probe 3	50 Ω	N2852A + N5449A	N2852A + N5442A	N2852A

See also,

- "How can I set the Infiniium Input to High-Z or 1 M?? How can I AC Couple my Infiniium oscilloscope input?"
- "<https://www.keysight.com/find/prc>"

High-Speed Electrical Test Bed Computer

The high-speed electrical test bed computer hosts a USB 2.0 compliance host controller for hi-speed hub or device electrical test, or serves as a test bed host for a USB 2.0 host controller under test. For instructions on configuring this computer, refer to the High-Speed Electrical Test Toolkit Setup Instruction document which comes with the High-Speed Electrical Test Tool Kit software.

You can download the High-Speed Electrical Test Tool Kit software (USBHSET) from the developers tools page at the USB Implementers Forum web site, <http://www.usb.org/developers/tools>.

The High-Speed Electrical Test Tool Kit software contains a proprietary EHCI driver stack. The Hi-speed Electrical Test Tool software requires the use of a proprietary EHCI driver stack. The use of this proprietary EHCI driver stack facilitates the electrical testing that requires direct control of the command registers of the USB EHCI host controllers. The end result much more robust test bed environment. Since the proprietary EHCI driver stack is designed for debug and test validation purposes, this driver stack does not support the normal functionality as found in the EHCI drivers from Microsoft (or the device vendor). An automatic driver stack switching function has been implemented into the Hi-speed Electrical Test Tool for easy switching between the proprietary EHCI driver stack and that from Microsoft. Upon invocation of the HS Electrical Test Tool software, the driver stack will automatically switch to the Intel proprietary EHCI driver stack. Upon exit of the HS Electrical Test Tool software, the driver stack will automatically switch to the Microsoft EHCI driver stack.

Table 6 High-Speed Electrical Test Bed Computer

Equipment Required	TESTS			
	Host Hi-Speed	Hub Hi-Speed	Device Hi-Speed	Low/Full Speed
High-Speed Electrical Test Bed Computer	1	1	1	1
High-Speed Electrical Test Tool Kit software (USBHSET)	1	1	1	1

E2649B USB 2.0 High-Speed Fixture Set

The E2649B high-speed fixture set includes four test fixtures. In the test procedures, separate instructions may be provided based on the version of the fixture that is being used. Fixture versions are identified by a part number, which are shown in the following table and marked on the fixture.

NOTE

The fixture part numbers are provided for *identification* purposes only and cannot be used for ordering.

NOTE

More info on supported fixtures is available on the following Keysight Care link:

[USB 2.0 Compliance Test Summary and Index of Knowledge*](#)

*This link is user restricted, and only with the requisite credentials can be accessed.

Table 7 Five E2649B Fixtures with Identification Numbers and Applicable Tests

Test Fixture Description	New Part Number	Old Part Number	TESTS			
			Host Hi-Speed	Hub Hi-Speed	Device Hi-Speed	Low/Full Speed
Device High Speed Signal Quality Test Fixture	E2649-60001	E2645-66507	1	1	1	n/a
Host High Speed Signal Quality Test Fixture	E2649-60002	E2645-66508	1	1	n/a	n/a
Receiver Sensitivity Test Fixture	E2649-60003	E2645-66503	n/a	1	1	n/a
Host Disconnect Test Fixture	E2649-60004	E2645-66506	1	n/a	n/a	n/a
HS Droop/Drop Fixture (1.x, 2.0 only) (discontinued)	E2649-60005	n/a	n/a	n/a	n/a	1

NOTE

A droop and drop test fixture is also required; contact the USB-IF for currently available products.

Table 8 Miscellaneous Equipment for use with Test Fixtures

Equipment Required	TESTS			
	Host Hi-Speed	Hub Hi-Speed	Device Hi-Speed	Low/Full Speed
5V test fixture power supply, Keysight P/N 0950-2546 or equivalent	1	1	1	n/a
E2646B/B SQiDD board, included in the USB test option.	n/a	n/a	n/a	1
100 mA load board (see the schematic in Figure 12 on page 183)				1
500 mA load board (see the schematic in Figure 13 on page 183)				1

Table 9 Contents of E2649B USB 2.0 High-Speed Fixture Set

Equipment Required	Qty	P/N
USB to right-angle DC-plug cable, 2m long,	1	8121-1966
USB 2.0 A (m) to USB 2.0 micro-B (m) cable, 4 inch	1	8121-2153
Device Hi-Speed Signal Quality test fixture. Includes:	1	n/a
RF SMA (m) vertical 50-ohm connector	2	n/a
USB A-to-B cable, 4 inch	2	E2646-61601
Host Hi-Speed Signal Quality test fixture. Includes:	1	n/a
RF SMA (m) vertical 50-ohm connector	2	n/a
USB A-to-B cable, 4 inch	2	E2646-6160
Receiver Sensitivity test fixture. Includes:	1	n/a
USB A-to-B cable, 4 inch	2	E2646-61601
Host Disconnect test fixture. Includes:	1	n/a

Table 9 Contents of E2649B USB 2.0 High-Speed Fixture Set

Equipment Required	Qty	P/N
USB A-to-B cable, 4 inch	2	E2646-61601
Droop/Drop test fixture. Includes:	1	n/a
USB A-B I-O 4COND 1.8m long cable, 1.8 meter	2	8121-1482

Setting Up the Equipment

Infiniium S-Series, 9000A, 90000A, MXR, or UXR Series Digital Sampling Oscilloscope

- 1 Connect keyboard and mouse to oscilloscope.
- 2 Connect optional computer monitor to the VGA connector on the rear nearest the right side of the instrument.

Differential Connection

- 3 Attach the Keysight 113xA/B differential probe to Channel 1 of the oscilloscope.
 - a Attach the socketed probe head to the differential probe amp.
 - b Attach the header adapter to the socketed probe head (Figure 5). This step is only needed if you are using the old test fixtures (E2645-66504, E2645-66505, E2645-66506, E2645-66507, E2645-66508). If you are using the new test fixtures (E2649-66401, E2649-66402, E2649-66403, E2649-66404, E2649-66405, or E2666B), you do not need to use a header adapter and can work with a socketed probe head.
 - c Handle the socketed probe head and header adapter carefully.
 - d For durability, epoxy can be used to strengthen the assembly. Only apply epoxy to back (noncomponent) side of probe head.

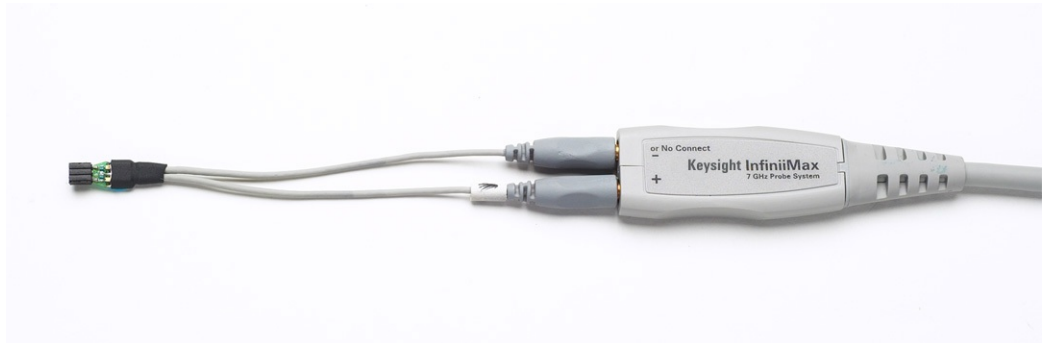

Figure 5 Differential Probe Setup

- 4 Attach the E2697A adapters or 1130B probes to Channels 2 and 3.
 - a When using the E2697A adapter, connect the 10073D miniature passive probes to the E2697A adapter.

NOTE

These probe assignments will be used through out the entire test procedure.

- 5 Turn on the oscilloscope to allow 30 minutes of warm up time prior to use.
- 6 Configure the second monitor, if being used, while the oscilloscope is warming up.
- 7 If the ambient temperature has changed more than 5 degrees from the previous calibration, perform the calibration procedure built into the oscilloscope (in the [Calibration...] section of [Utilities] pull down menu).
- 8 If the E2697A adapter is being used, compensate the passive probes (see probe instructions).

- 9 Calibrate all the probes.
 - a If you will be performing hub hi-speed tests, calibrate out the skew between the differential probes on channel 1 and channel 4 (refer to oscilloscope instructions).

NOTE

In certain test situations, there may not be a ground connection between the DSO and the device under test. This may lead to the signal seen by the differential probe to be modulated up and down due to the mid-frequency switching power supply. Connecting the DSO ground to the DUT ground will be required to establish a common ground reference.

Single-Ended Connection

The following tests allow single-ended SMA connection measurements:

- Device Hi-Speed Signal Quality Test
- Device Hi-Speed Manual Tests
- Hub Hi-Speed Signal Quality Test
- Hub Hi-Speed Manual Tests
- Host Hi-Speed Signal Quality Test
- Host Hi-Speed Manual Tests

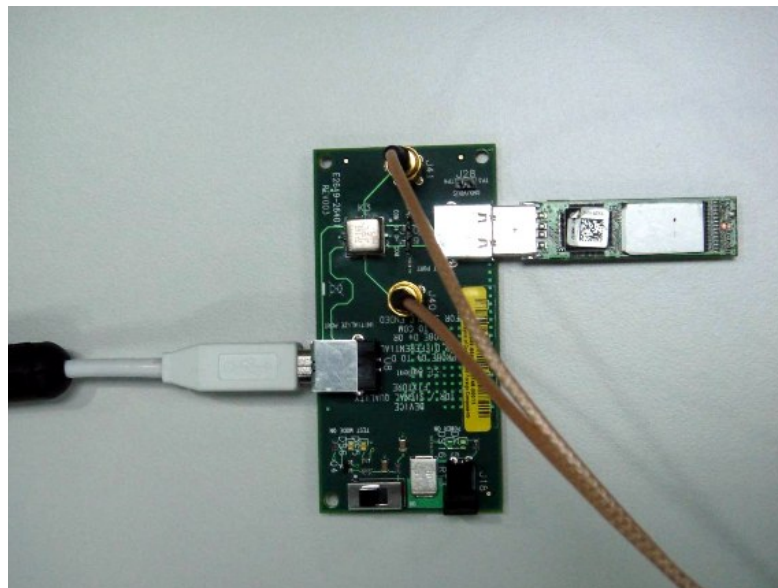

81160A Digital Signal Generator

The digital signal generator is needed to perform hi-speed hub and device receiver sensitivity tests. For energy conservation, you may choose to turn on the digital signal generator about 15 minutes prior to performing these measurements.

Starting the USB 2.0 Compliance Test Application

- 1 From the Infiniium oscilloscope's main menu, choose **Analyze > Automated Test Apps > D9010USBC USB Test App**.

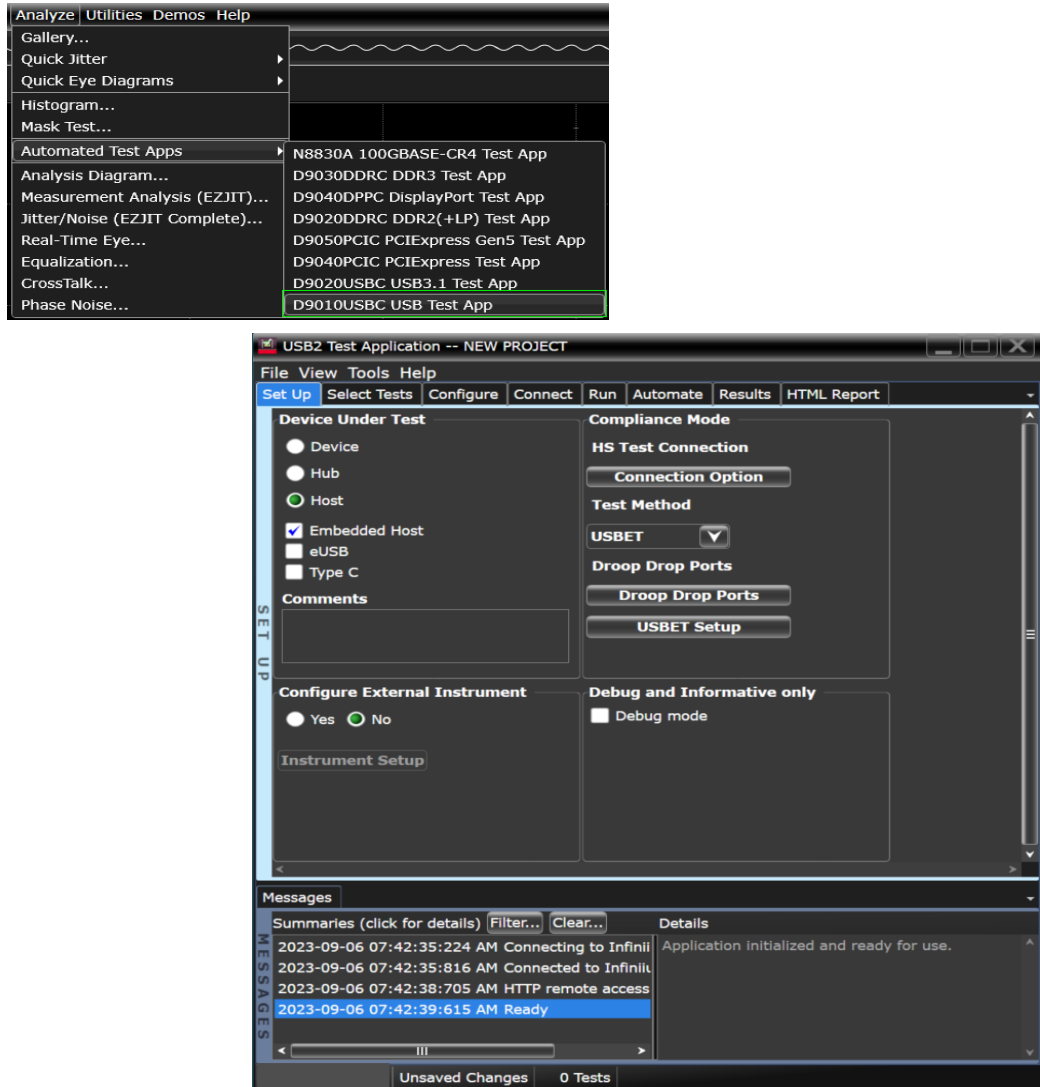

Figure 6 The USB 2.0 Compliance Test Application

NOTE

If “USB Test” does not appear in the Automated Test Apps menu, the USB 2.0 Compliance Test Application has not been installed (see [Chapter 1](#), “Installing the USB 2.0 Compliance Test Application”).

Figure 6 shows the USB 2.0 Compliance Test Application main window. The task flow pane, and the tabs in the main pane, show the steps you take in running the automated tests:

Task Flow Tab	Description
Set Up	Lets you identify the test environment, including information about the device being tested and other test instruments that can be automatically configured. The new Hi-Speed fixtures allow you to choose between either differential or single-ended connections (old fixtures only permit differential connections). The Test Method choice lets you choose between doing tests automatically or manually. If you want to do the tests automatically, select USBET for this box. If you want to do the tests manually, select Both for this box. When you select Both and then go under the Select Tests tab, you will see that some manual tests appear. These test only use the oscilloscope whereas the automatic ones use USBET. Also, if you are using the new Drop/Droop test fixture, check the New DroopDrop Fixture box and use the button above it to select the test ports.
Select Tests	Lets you select the tests you want to run. The tests are organized hierarchically so you can select all tests in a group. After tests are run, status indicators show which tests have passed, failed, or not been run, and there are indicators for the test groups.
Configure	Lets you configure test parameters
Connect	Shows you how to connect the oscilloscope to the device under test for the tests to be run.
Run Tests	Starts the automated tests. If the connections to the device under test need to be changed while multiple tests are running, the tests pause, show you how to change the connection, and wait for you to confirm that the connections have been changed before continuing.
Results	Contains more detailed information about the tests that have been run. You can change the thresholds at which marginal or critical warnings appear.
HTML Report	Shows a compliance test report that can be printed. You can choose between a verbose and compact report.

Online Help Topics

For information on using the USB 2.0 Compliance Test Application, see its online help (which you can access by choosing **Help > Help Contents...** from the application's main menu).

The USB 2.0 Compliance Test Option's online help describes:

- D9010USBC USB2.0 Automated Testing—At a Glance
- Starting the D9010USBC USB2.0 Test Application
- Creating or Opening a Test Project
- Setting Up the Test Environment
- Selecting Tests
- Configuring Tests
- Verifying Physical Connections
- Running Tests
- Configuring Automation in the Test Application
- Viewing Results
- Viewing HTML Test Report
- Exiting the Test Application
- Additional Settings in the Test App

Running Tests

To run USB electrical compliance tests:

- 1 Select the tests you want to run.
- 2 Change test configuration options if necessary.
- 3 Connect the oscilloscope to the device under test.
- 4 Run the tests.
- 5 View the detailed test results.
- 6 View/print the HTML test report.

3 Device Hi-Speed Tests

Device Hi-Speed Signal Quality Test	39
Device Packet Parameters	46
Device CHIRP Timing	53
Device Suspend/Resume/Reset Timing	56
Device Test J/K, SEO_NAK	64
Device Receiver Sensitivity	70

NOTE

To give the automated test software more flexibility in making corner case measurements (and improve test performance), the oscilloscope's memory upgrade option is recommended (Option 001 when ordered with the oscilloscope, or after purchase: N5472A for the 90000A Series oscilloscopes).

In addition to the hi-speed electrical tests described in this chapter, the device under test must also pass the following compliance tests applicable to hi-speed capable devices:

- Upstream full speed signal quality.
- Upstream low speed signal quality.
- Inrush current.
- Back-voltage.

Before Running These Tests

If you haven't already performed the initial equipment set up, see "[Setting Up the Equipment](#)" on page 30.

Selecting the Device Test Environment Setup

- 1 In the USB automated test application, select the **Device** test environment.
- 2 To do automatic testing, select **USBET** as the **Test Method**. To do manual testing, select **Both** as the **Test Method**.

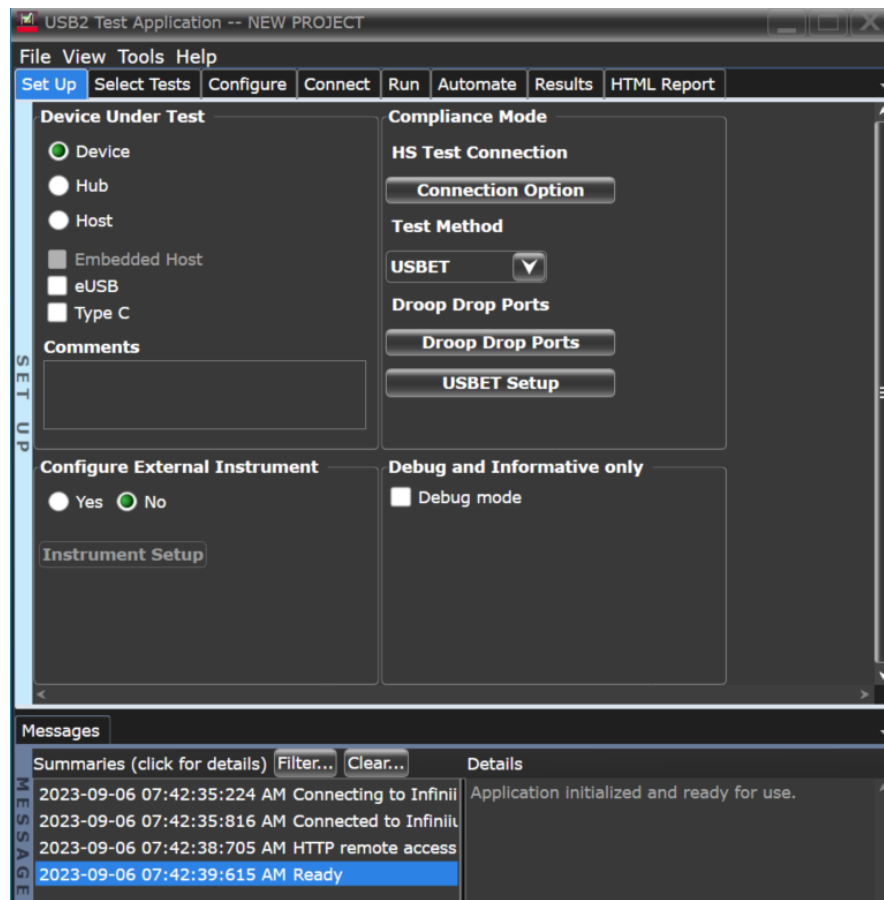

Device Hi-Speed Signal Quality Test

Equipment Used

Table 10 Equipment Used in Device Hi-Speed Signal Quality Tests

Quantity	Item	Description/Model
1	Oscilloscope	Keysight S-Series, 9000A, 90000A, MXR, or UXR Series
1	Probe type	Differential active (at least 2.5 GHz bandwidth) with E2678B socketed probe head
1	Header adapter (only needed if you are using the old test fixture - E2645-66507)	Keysight 01131-68703
1	Host test bed computer	Any computer with hi-speed USB ports
1	Device Hi-Speed Signal Quality test fixture and 4" USB cable	Keysight E2666B
1	5V power supply	Keysight 8121-1966 or equivalent

Selecting the Tests

To do manual testing, choose **Both** for the **Test Method** option under the **Set Up** tab. There will then be several manual tests to choose from under the **Select Tests** tab.

NOTE

When eUSB option is selected, in case of Signal Quality tests, the test app applies a different set of test limits, specific to eUSB type DUT.

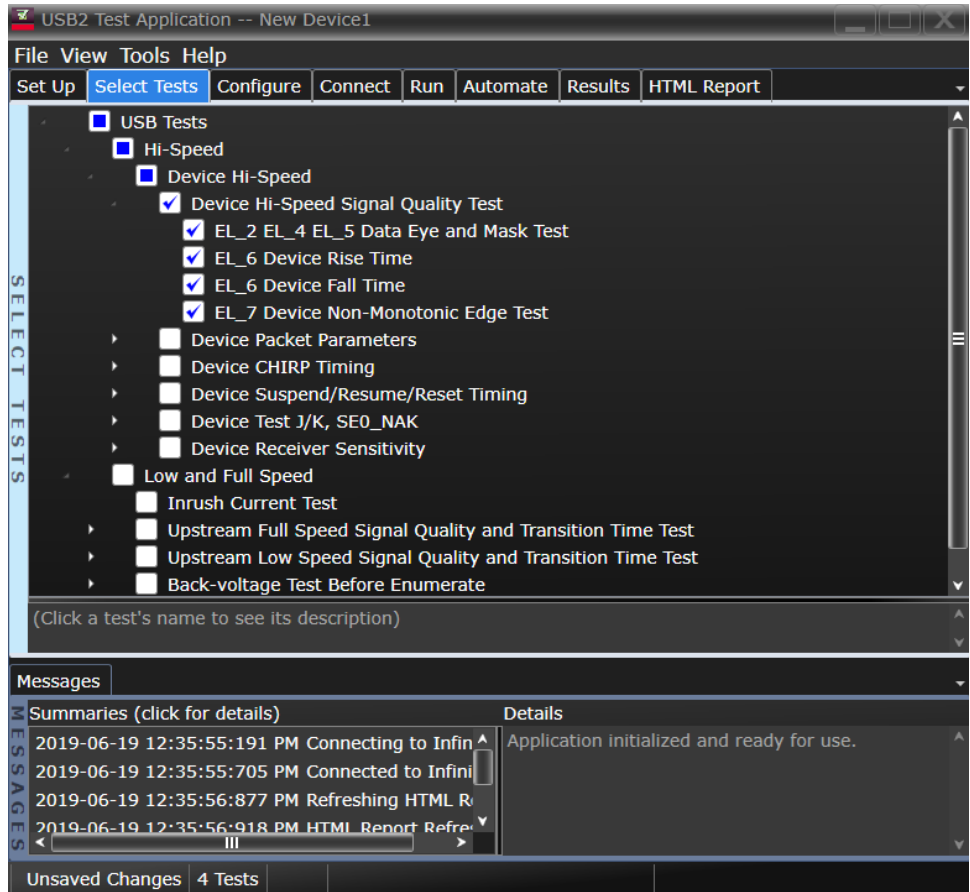

Configuring the Tests

Configure High Speed Signal Quality Test Fixture Selection

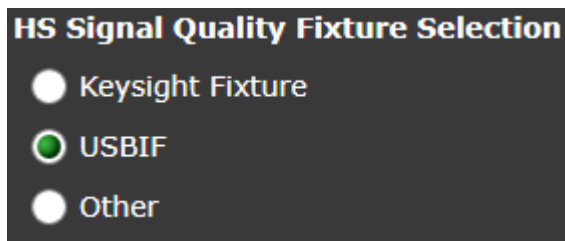

These settings affect ONLY the HS Signal Quality tests. They can be used to embed/de-embed the fixture. These settings DO NOT remove the differential probe or SMA cables.

Selecting "Keysight Fixture"

Selecting "Keysight Fixture" de-embeds the Keysight HS Device or Host Signal Quality fixtures and a short (4") cable.

Selecting "USBIF Fixture"

Selecting "USBIF Fixture" does not embed/de-embed the fixture.

Selecting "Other"

Selecting "Other" allows you to use any fixture and/or cable you have characterized.

- 1 Create a transfer function in InfiniiSim (outside the scope of this document; requires InfiniiSim license to create a transfer function file; one can move those files from oscilloscope to oscilloscope...)
- 2 Select "Other"
- 3 In the USB2 software, go to the Tools > Infiniium > InfiniiSim...; then, configure the new dialog box as it was when the transfer function was created.

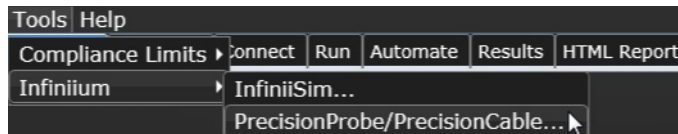

Connecting the Equipment - Differential Connection

The USB automated test application will prompt you to perform these connection steps:

- 1 Attach the 5V power supply to J5 of the E2649-66401 (E2645-66507 if you are using the old fixture) Device Hi-Speed signal quality test fixture. Leave the TEST switch at the OFF position. Verify the green Power LED is lit and the yellow Test LED is not lit.
- 2 Connect the [TEST PORT] of the Device Hi-speed Signal Quality test fixture into the upstream facing port of the device under test, using the 4" USB cable.
- 3 Connect the [INIT PORT] of the test fixture to a Hi-speed capable port of the Test Bed Computer, using a USB cable.
- 4 Apply power to the device.
- 5 Attach the differential probe to D+/D- of TP2 on the test fixture, using compatible header adapter (the header adapter is only needed if you are using the old test fixture). Ensure the + polarity on the probe lines up with D+.
- 6 If you are using the new fixture, please terminate the SMA connectors with 50 Ohm terminators.

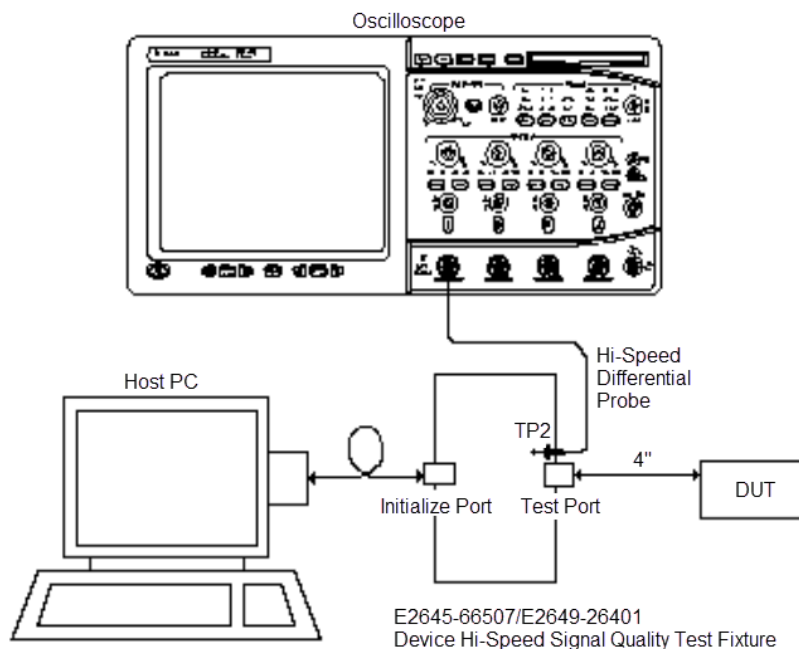

7 Check **I have completed these instructions.**

Connecting the Equipment - Single-Ended Connection

- 1 Attach the 5V power supply to J5 of the E2649-66401 (E2645-66507 if you are using the old fixture) Device Hi-Speed signal quality test fixture. Leave the TEST switch at the OFF position. Verify the green Power LED is lit and the yellow Test LED is not lit.
- 2 Connect the [TEST PORT] of the Device Hi-speed Signal Quality test fixture into the upstream facing port of the device under test, using the 4" USB cable.
- 3 Connect the [INIT PORT] of the test fixture to a Hi-speed capable port of the Test Bed Computer, using the 5 meter USB cable.
- 4 Apply power to the device.
- 5 Attach the SMA cables to the SMA connectors D+ and D- on the test fixture.

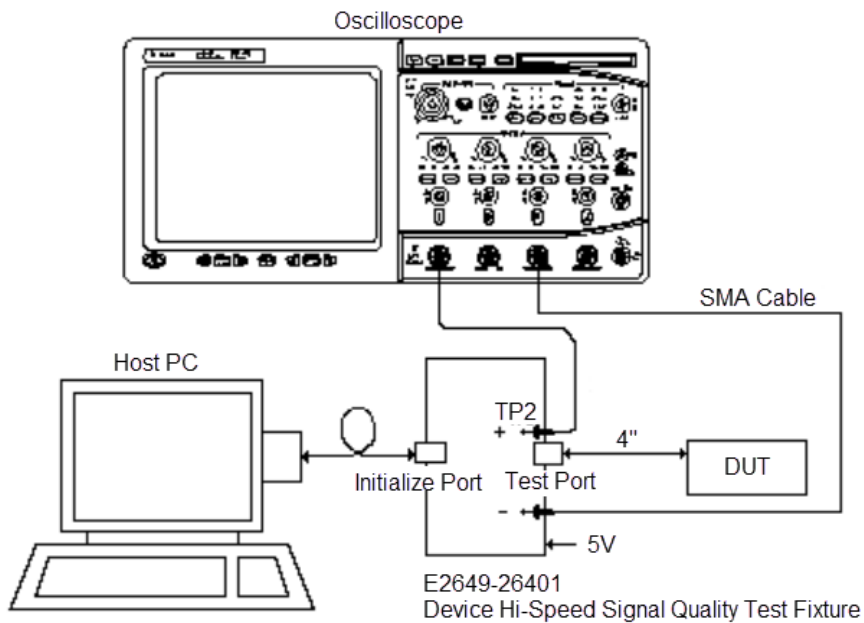

- 6 Check **I have completed these instructions.**

Running the Tests

- 1 Click **Run Tests.**

Test Instructions, Part 1

The USB automated test application will prompt you to perform these steps:

- 1 Invoke the HS Electrical Test Tool software on the Hi-Speed Electrical Test Bed computer.
- 2 Select Device and click the [TEST] button to enter the Device Test menu.

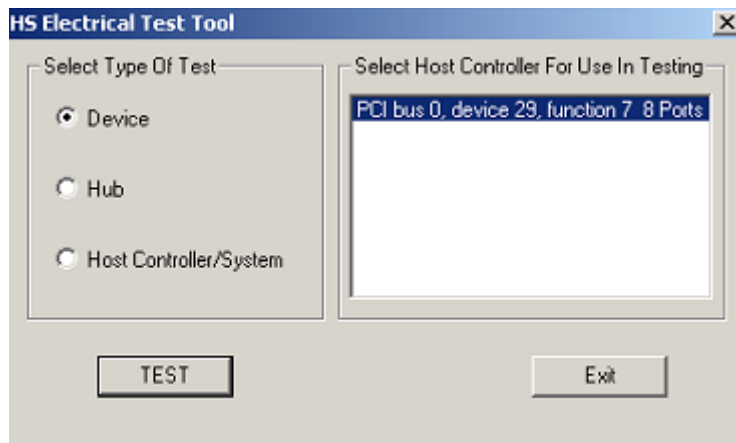

- 3 Click **OK** to close the Test Instructions dialog.

Test Instructions, Part 2

The USB automated test application will prompt you to perform these steps:

- 1 The device under test should be enumerated with the device's VID shown together with the root port in which it is connected.
- 2 Select **TEST_PACKET** from the Device Command drop down menu and click **[EXECUTE]**. This forces the device under test to continuously transmit test packets.

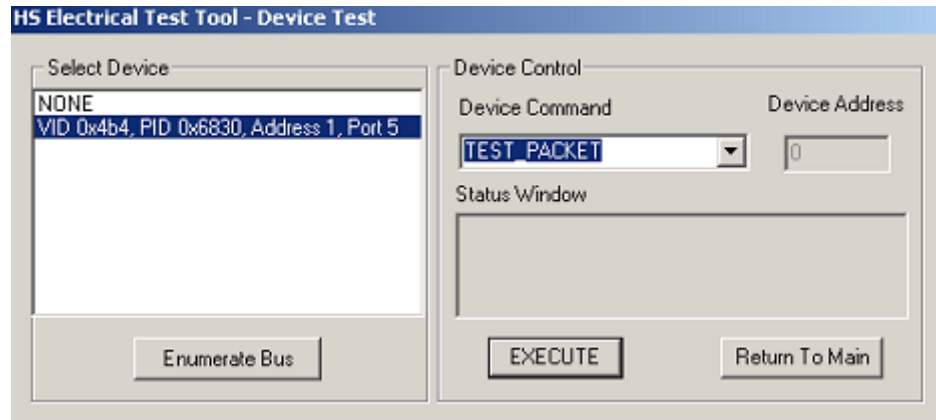

- 3 Place the Test Switch (S1) in the **TEST** position. Verify the yellow TEST LED is lit. You should see the transmitted test packet on the oscilloscope as below.

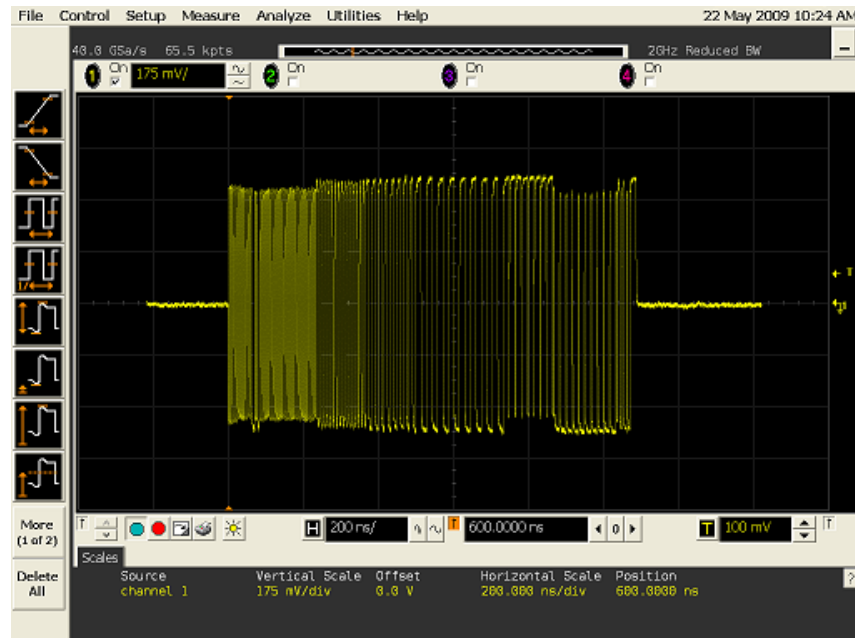

- 4 Click **OK** to close the Test Instructions dialog.

EL_6 Rise Time**EL_6 Fall Time****EL_2 EL_4 EL_5 Data Eye and Mask Test**

After viewing the test results, click **OK** to close the Test Instructions dialog.

EL_7 Non-Monotonic Edge Test

Viewing Test Results

- 1 When the Testing Complete dialog appears, click **OK**.
The Results tab shows the test results.

Device Packet Parameters

Equipment Used

Table 11 Equipment Used in Device Packet Parameters Tests

Quantity	Item	Description/Model
1	Oscilloscope	Keysight S-Series, 9000A, 90000A, MXR, or UXR Series
1 (diff.) 2 (active)	Probe type	Differential active (at least 2.5 GHz bandwidth) with E2678B socketed probe head (for differential connection) or active probe (for single-ended connection)
1	Header adapter (only needed if you are using the old test fixture - E2645-66507)	Keysight 01131-68703
1	Host test bed computer	Any computer with hi-speed USB ports
1	Device Hi-Speed Signal Quality test fixture and 4" USB cable	Keysight E2666B

Selecting the Tests

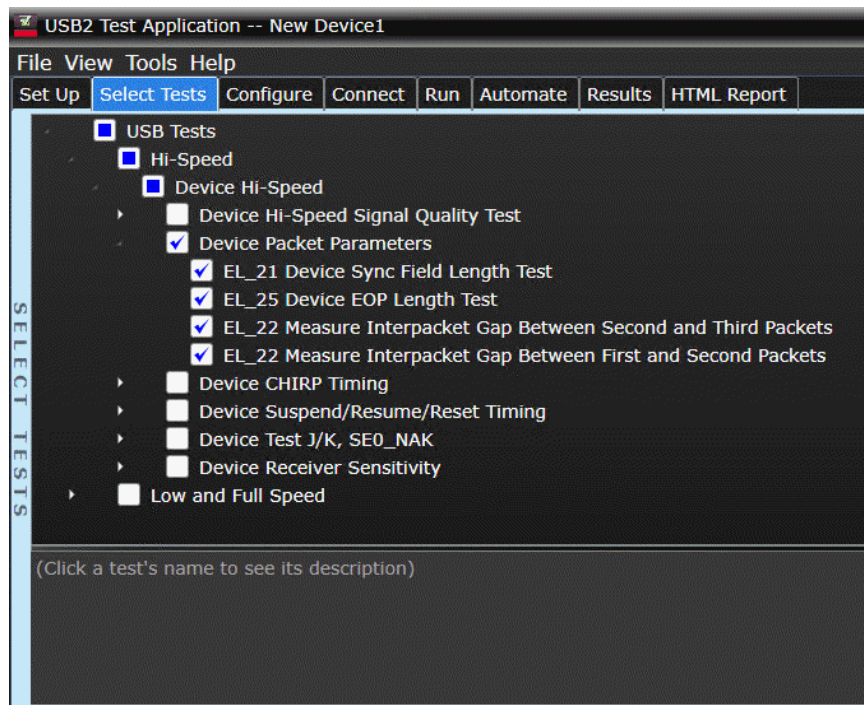

Figure 7 Device packet parameter tests

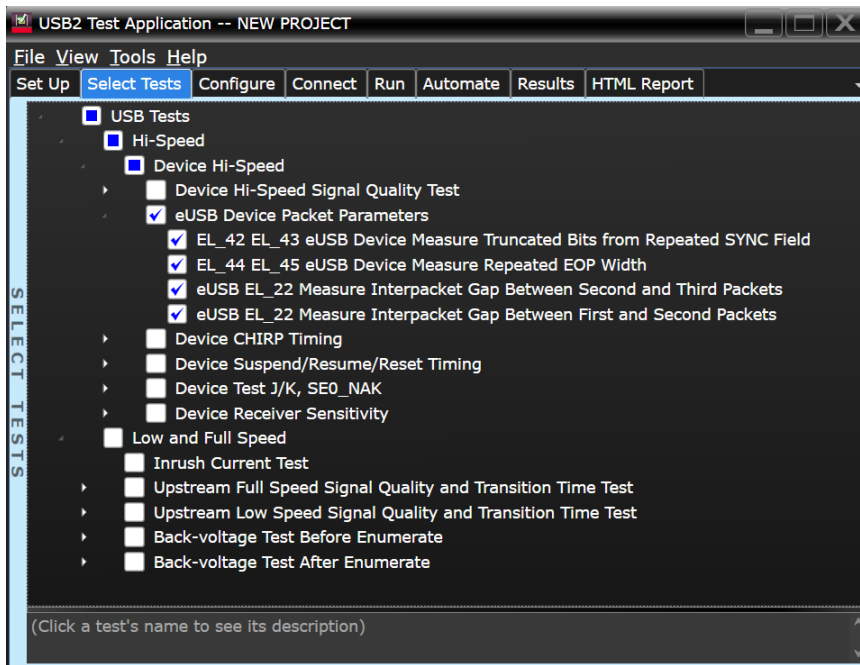

Figure 8 Device packet parameter tests - eUSB option selected

Connecting the Equipment - Single-Ended Connection

The USB automated test application will prompt you to perform these connection steps:

- 1 Remove the 5V supply. Connect the Device Hi-Speed Signal Quality test fixture ([INIT PORT]) to a high-speed capable port of the test bed, using a USB cable.
- 2 Connect the test fixture [TEST PORT] into B receptacle of the upstream facing port of the device under test, using the 4" USB cable. Apply power to the device.
- 3 Ensure that the test switch on the test fixture is in the OFF position and the test LED is not lit.
- 4 Attach active probes on undefined and undefined to D+ and D- on the test fixture, respectively.
- 5 Check **I have completed these instructions**.

NOTE

1. If you are using E2649-26401/E2649-26402/E2649-26403/E2649-26404 you would not need to use the damped header adapter.
2. If you are using differential test connections for E2649-26401/E2649-26402/E2649-26403, please terminate the SMA connector with 50 Ohm terminators.

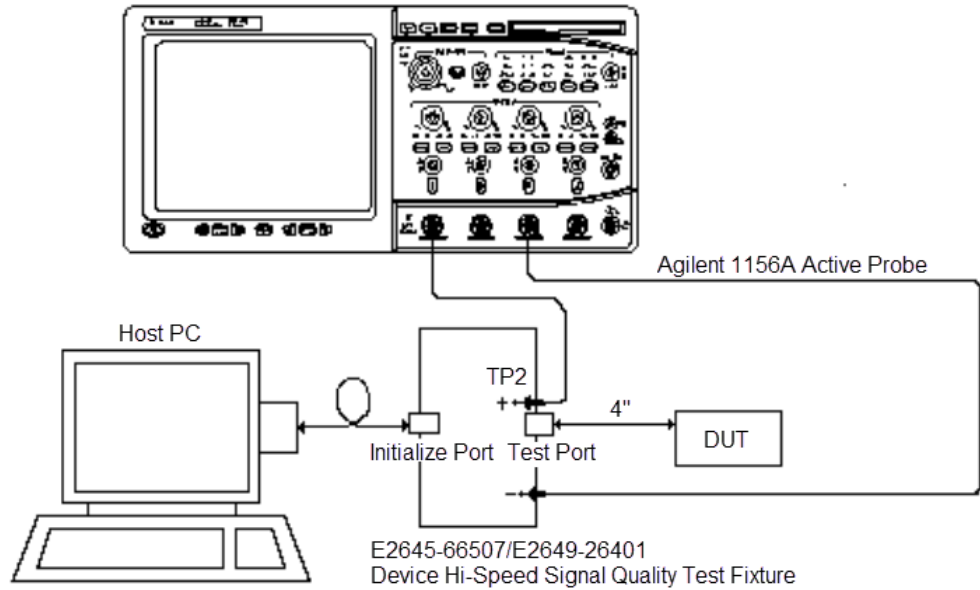

Connecting the Equipment - Differential Connection

The USB automated test application will prompt you to perform these connection steps:

- 1 Remove the 5V supply. Connect the Device Hi-Speed Signal Quality test fixture ([INIT PORT]) to a high-speed capable port of the test bed, using a USB cable.
- 2 Connect the test fixture [TEST PORT] into B receptacle of the upstream facing port under test of the device, using the 4" USB cable. Apply power to the device.
- 3 Ensure that the test switch on the test fixture is in the OFF position, and the test LED is not lit.
- 4 Attach a differential probe on Channel 1 to D+ and D- of TP2 of the test fixture, using a compatible header adapter.

NOTE

1. If you are using E2649-26401/E2649-26402/E2649-26403/E2649-26404 you would not need to use the damped header adapter.
2. If you are using differential test connections for E2649-26401/E2649-26402/E2649-26403, please terminate the SMA connector with 50 Ohm terminators.

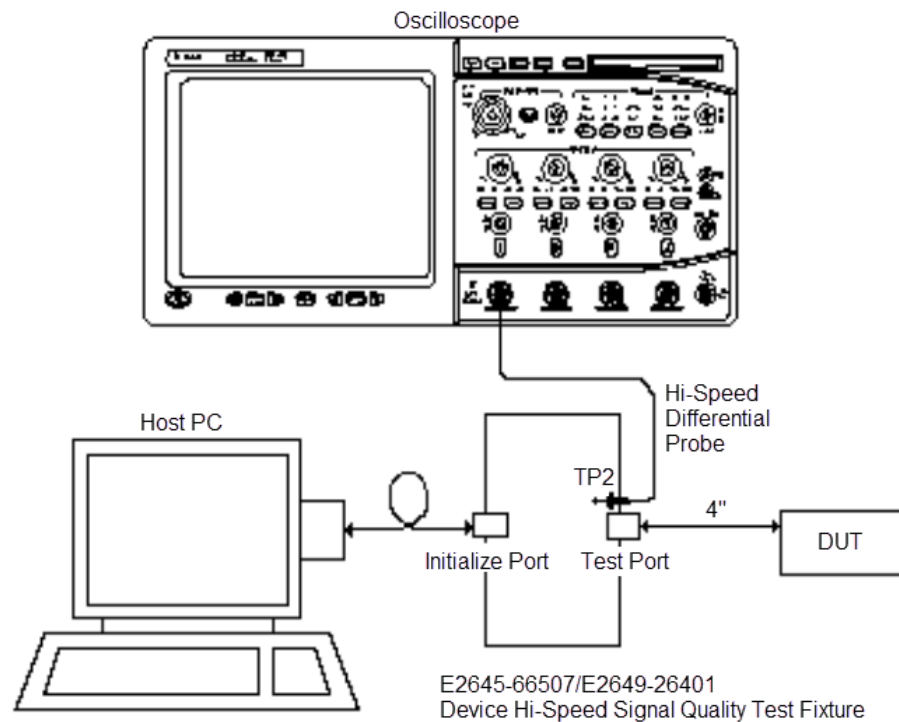

- 5 Check **I have completed these instructions**.

Running the Tests

- 1 Click **Run Tests**.

Test Instructions, Part 1

The USB automated test application will prompt you to perform these steps:

- 1 Cycle the device power to restore the device to normal operation. On the Device Test Menu of the HS Electrical Tool, click **Enumerate Bus** once.

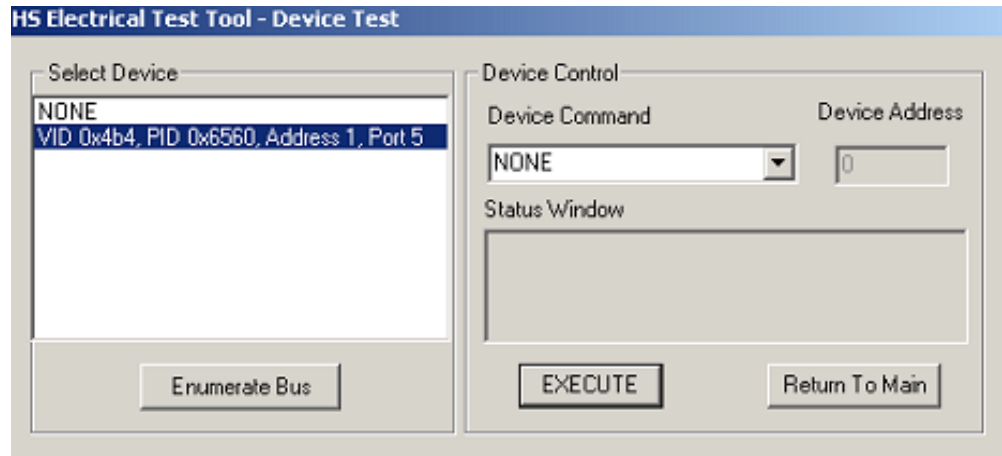

- 2 Using the oscilloscope, verify the SOFs (Start Of Frame) packets are being transmitted on the port under test. You may need to lower the trigger level to somewhat below 400 mV.

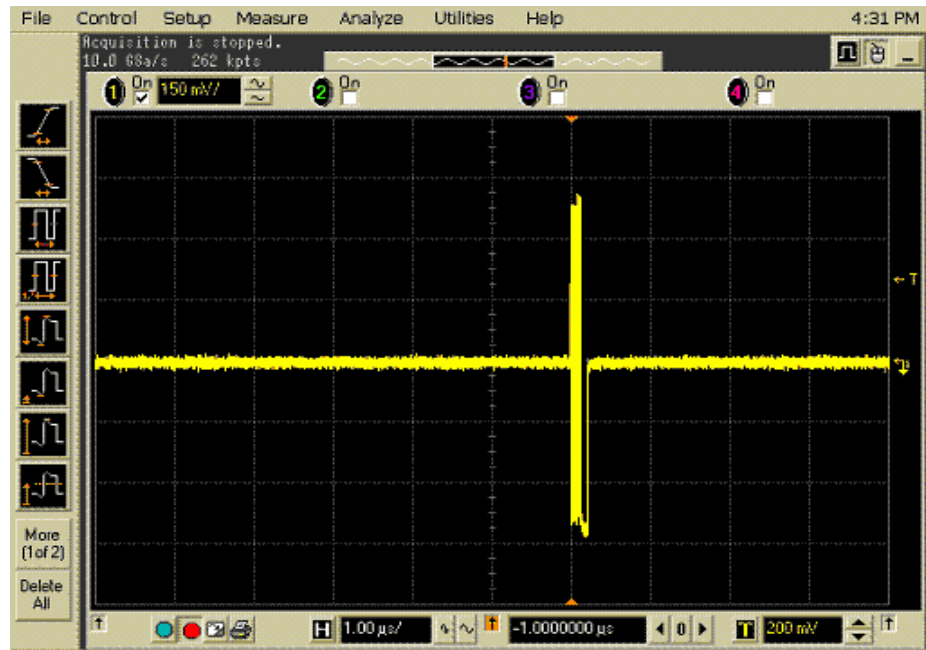

- 3 Click **OK** to close the Test Instructions dialog.

Test Instructions, Part 2

The USB automated test application will prompt you to perform these steps:

- 1 In the Device Test menu of the HS Electrical Test Tool, ensure that the hub under test is selected.
- 2 Select **SINGLE STEP SET FEATURE** from the Device Command window. Click **[EXECUTE]** once.

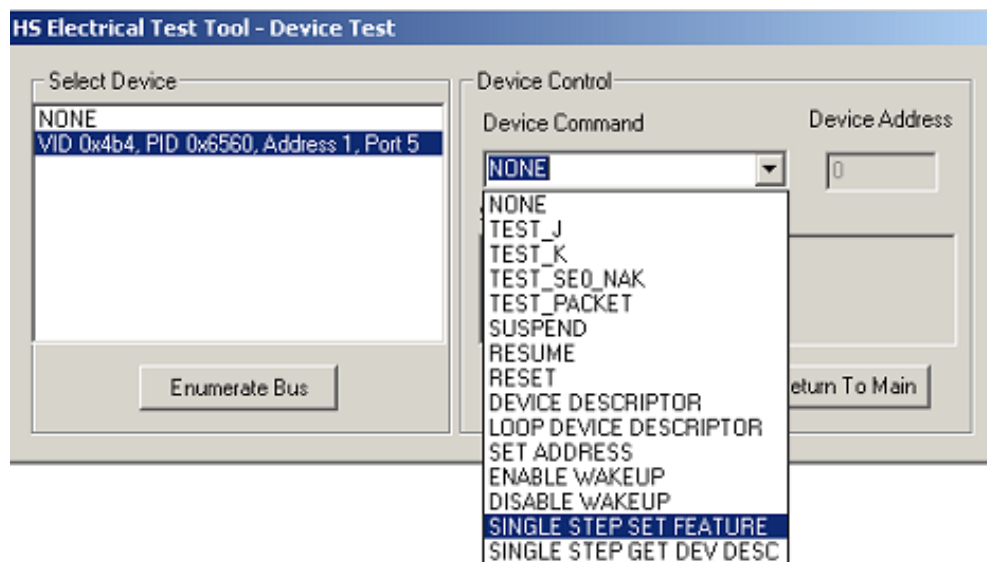

- 3 You should see the transmitted test packet on the oscilloscope as below.



- 4 Click **OK** to close the Test Instructions dialog.

EL_21 Sync Field Length Test

EL_25 EOP Length Test

EL_22 Measure Interpacket Gap Between Second and Third Packets

EL_22 Measure Interpacket Gap Between First and Second Packets

The USB automated test application will prompt you to perform these steps:

- 1 In the Device Test menu of the HS Electrical Test Tool, click **[STEP]** once again. This is the second step of the two-step Single Step Set Feature command.

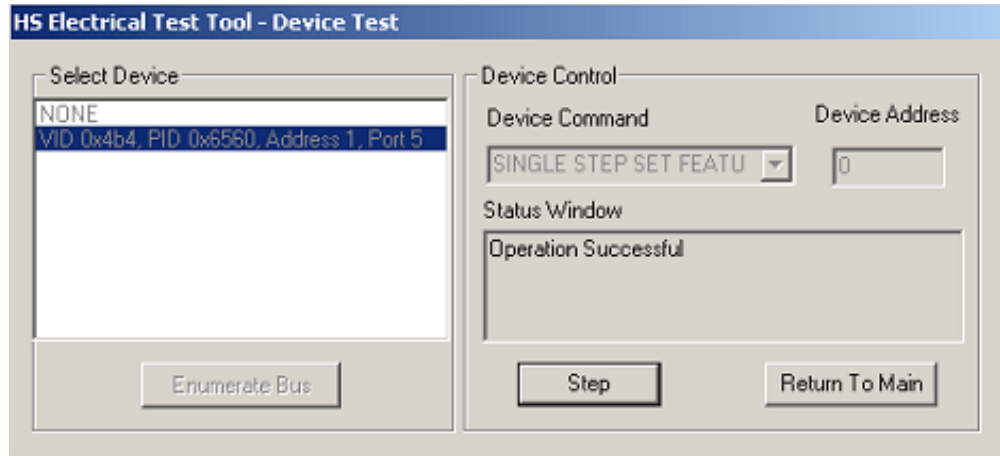

- 2 You should see the transmitted test packet on the oscilloscope as below.

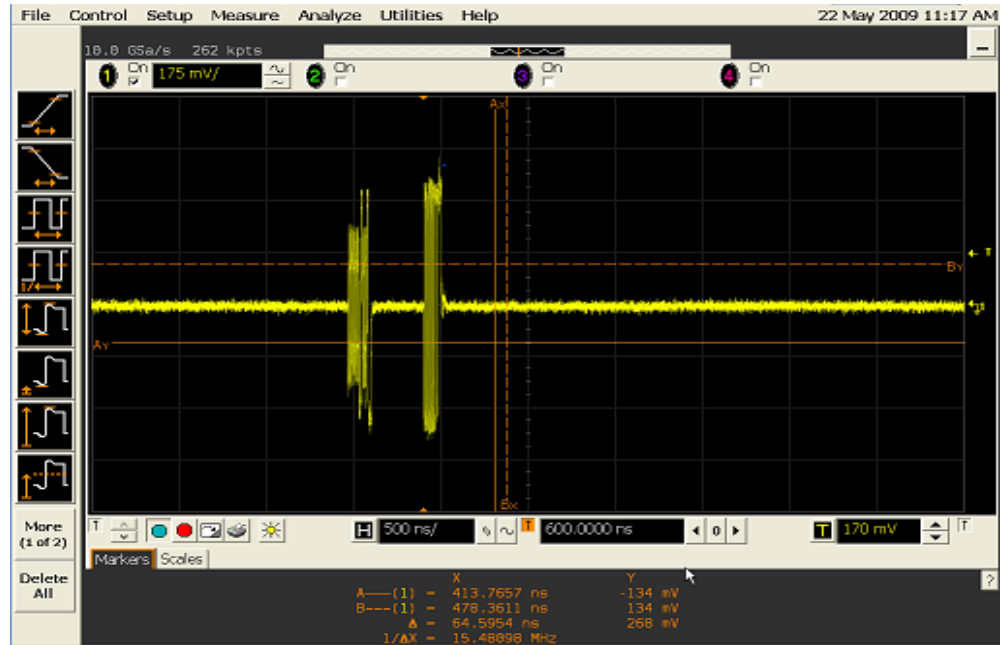

- 3 Click **OK** to close the Test Instructions dialog.

Viewing Test Results

- 1 When the Testing Complete dialog appears, click **OK**. The Results tab shows the test results.

Device CHIRP Timing

Equipment Used

Table 12 Equipment Used in Device CHIRP Timing Tests

Quantity	Item	Description/Model
1	Oscilloscope	Keysight S-Series, 9000A Series, or 90000A Series
2	Probe type	Passive
1	Host test bed computer	Any computer with hi-speed USB ports
1	Device Hi-Speed Signal Quality test fixture and 4" USB cable	Keysight E2666B
1	5 meter USB 2.0 hi-speed cable	Any listed on USB-IF web site

Selecting the Tests

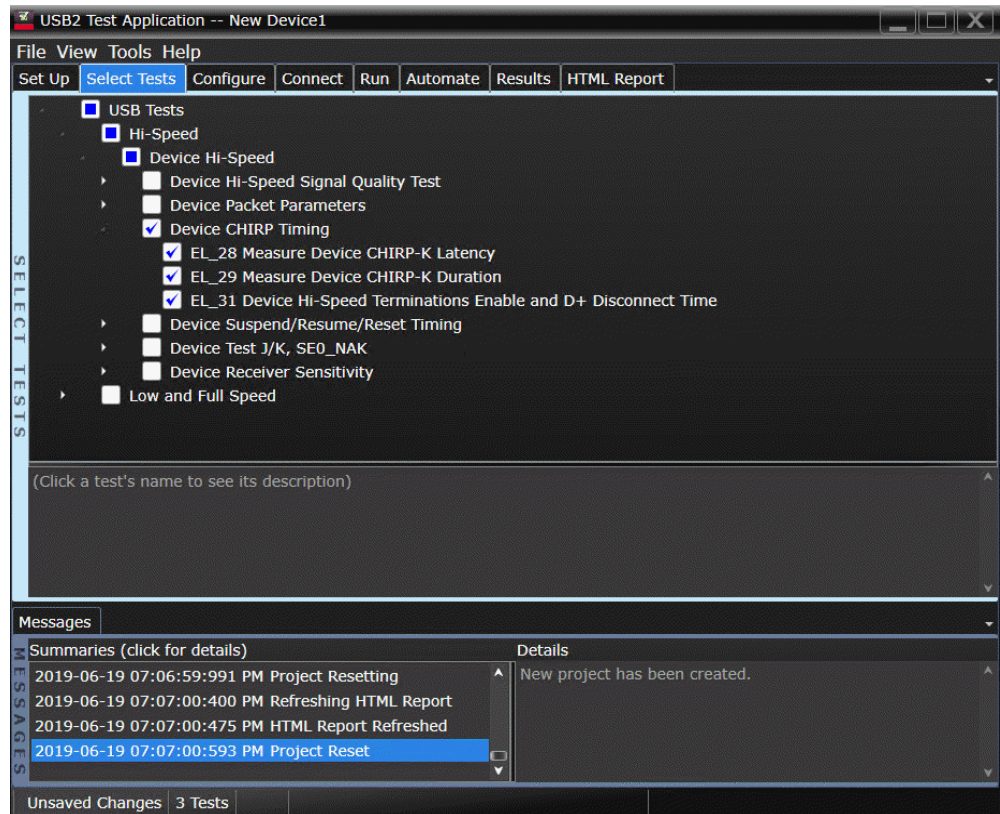

Configuring the Tests

Connecting the Equipment

The USB automated test application will prompt you to perform these connection steps:

- 1 Connect a compatible high impedance adapter with passive probe or an active probe on Channel 2 to the D- pin at TP2 of the E2649-26401 (E2645-66507 if you are using the old test fixture) Device Hi-Speed Signal Quality test fixture.
- 2 Connect a compatible high impedance adapter with passive probe on Channel 3 to the D+ pin at TP2.
- 3 Connect both probe grounds to GND leads.
- 4 Connect the [INIT PORT] of the test fixture to the HS host controller port, using USB cable.
- 5 Connect the [TEST PORT] on the fixture to the upstream port of the device under test. Do not apply 5V to the test fixture.
- 6 If you are using the new fixture, please terminate the SMA connectors with 50 Ohm terminators.

NOTE

1. If you are using differential test connections for E2649-26401/E2649-26402/E2649-26403, please terminate the SMA connector with 50 Ohm terminators.
2. E2697A is not needed for DSO9000 series oscilloscope.

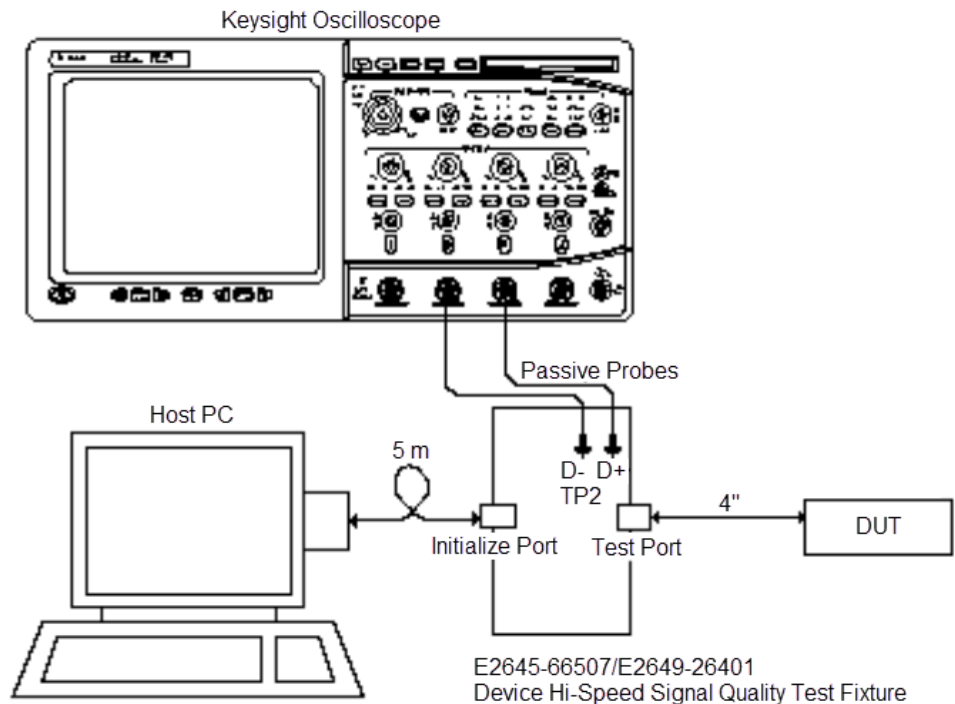

- 7 Check **I have completed these instructions.**

Running the Tests

- 1 Click **Run Tests**.

Test Instructions

The USB automated test application will prompt you to perform these steps:

- 1 On the HS Electrical Test Tool software, click [**Enumerate Bus**] once. You should capture the CHIRP handshake as in the below figure.

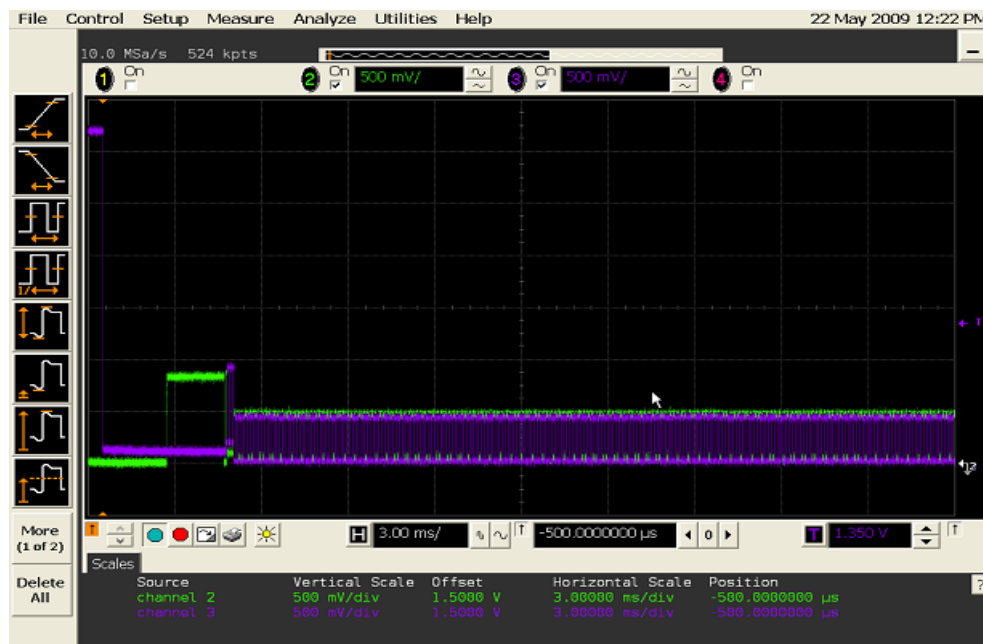

- 2 Click **OK** to close the Test Instructions dialog.

EL_28 Measure Device CHIRP-K Latency

EL_29 Measure Device CHIRP-K Duration

EL_31 Hi-Speed Terminations Enable and D+ Disconnect Time

Viewing Test Results

- 1 When the Testing Complete dialog appears, click **OK**.
The Results tab shows the test results.

Device Suspend/Resume/Reset Timing

Equipment Used

Table 13 Equipment Used in Device Suspend/Resume/Reset Timing Tests

Quantity	Item	Description/Model
1	Oscilloscope	Keysight S-Series, 9000A, 90000A, MXR, or UXR Series
2	Probe type	Passive
1	Host test bed computer	Any computer with hi-speed USB ports
1	Device Hi-Speed Signal Quality test fixture and 4" USB cable	Keysight E2666B
1	5 meter USB 2.0 hi-speed cable	Any listed on USB-IF web site

Selecting the Tests

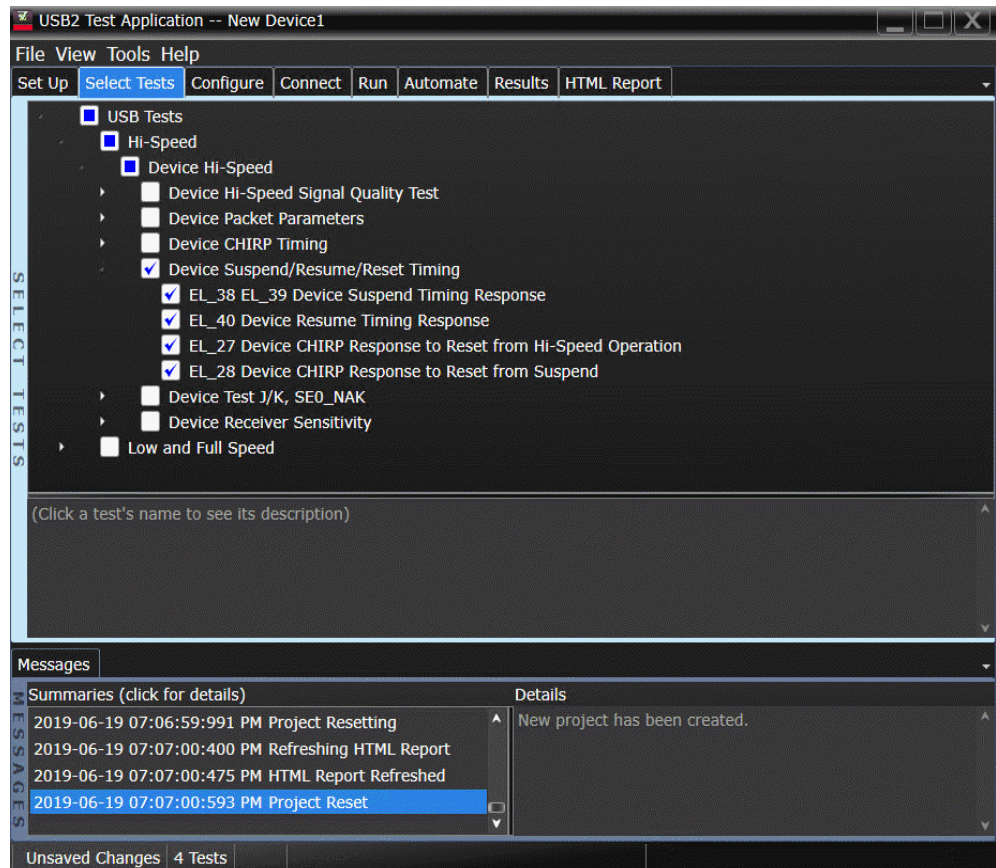

Configuring the Tests

Connecting the Equipment

The USB automated test application will prompt you to perform these connection steps:

- 1 Connect a compatible high impedance adapter with passive probe or an active probe on Channel 2 to the D- pin at TP2 of the E2649-26401 (E2645-66507 if you are using the old test fixture) Device Hi-Speed Signal Quality test fixture.
- 2 Connect a compatible high impedance adapter with passive probe or on Channel 3 to the D+ pin at TP2.
- 3 Connect both probe grounds to GND leads.
- 4 Connect the [INIT PORT] of the test fixture to the HS host controller port, using USB cable.
- 5 Connect the [TEST PORT] on the fixture to the upstream port of the device under test. Do not apply 5V to the test fixture.
- 6 If you are using the new fixture, please terminate the SMA connectors with 50 Ohm terminators.

NOTE

1. If you are using differential test connections for E2649-26401/E2649-26402/E2649-26403, please terminate the SMA connector with 50 Ohm terminators.
2. E2697A is not needed for DSO9000 series oscilloscope.

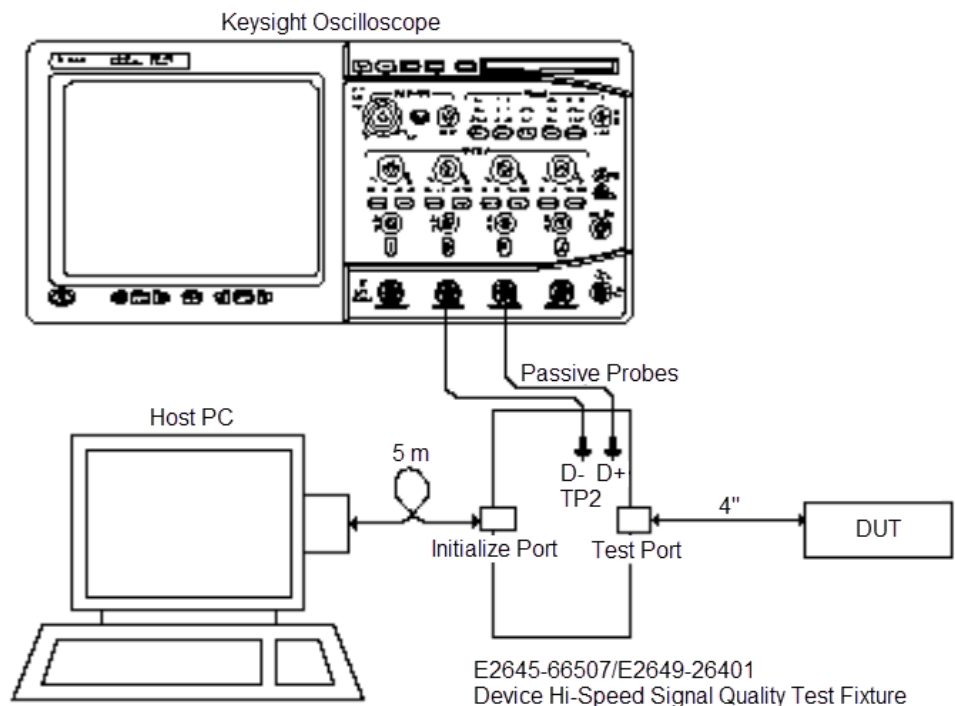

- 7 Check **I have completed these instructions.**

Running the Tests

- 1 Click **Run Tests**.

Test Instructions

EL_38 EL_39 Suspend Timing Response

The USB automated test application will prompt you to perform these steps:

- 1 On the Device Test Menu of the HS Electrical Test Tool software, click [**Enumerate Bus**] once.
- 2 Select **SUSPEND** from the Device Command drop down menu. Click [**EXECUTE**] once to place the device into suspend. The captured transition should be as in the figure below.

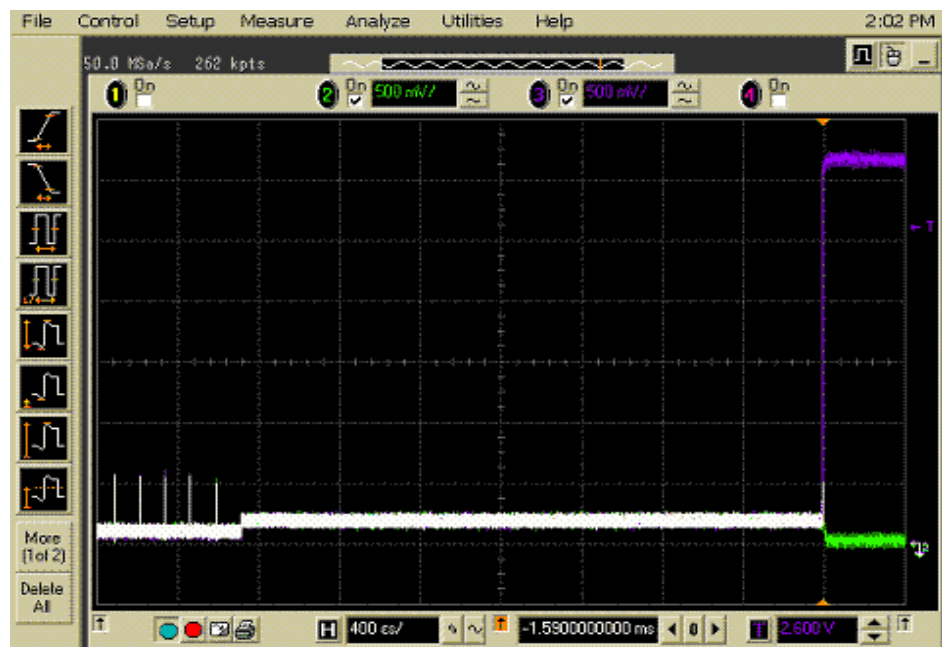
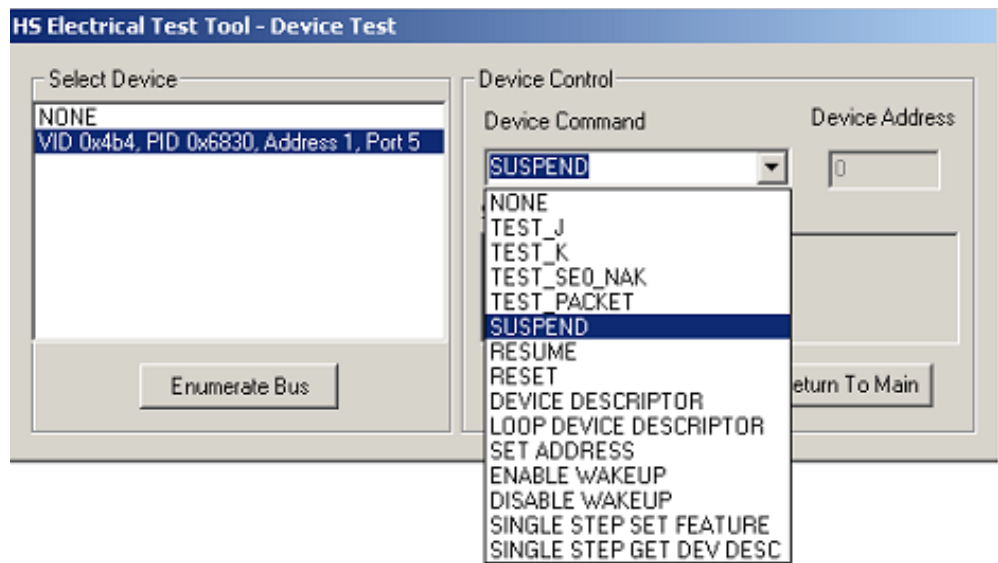

- 3 Click **OK** to close the Test Instructions dialog.

EL_40 Resume Timing Response

The USB automated test application will prompt you to perform these steps:

- 1 On the Device Test Menu of the HS Electrical Test Tool, select **RESUME** from the Device Command drop down menu. Click **[EXECUTE]** once to resume the hub from suspend. The captured transition should be as in the figure below.

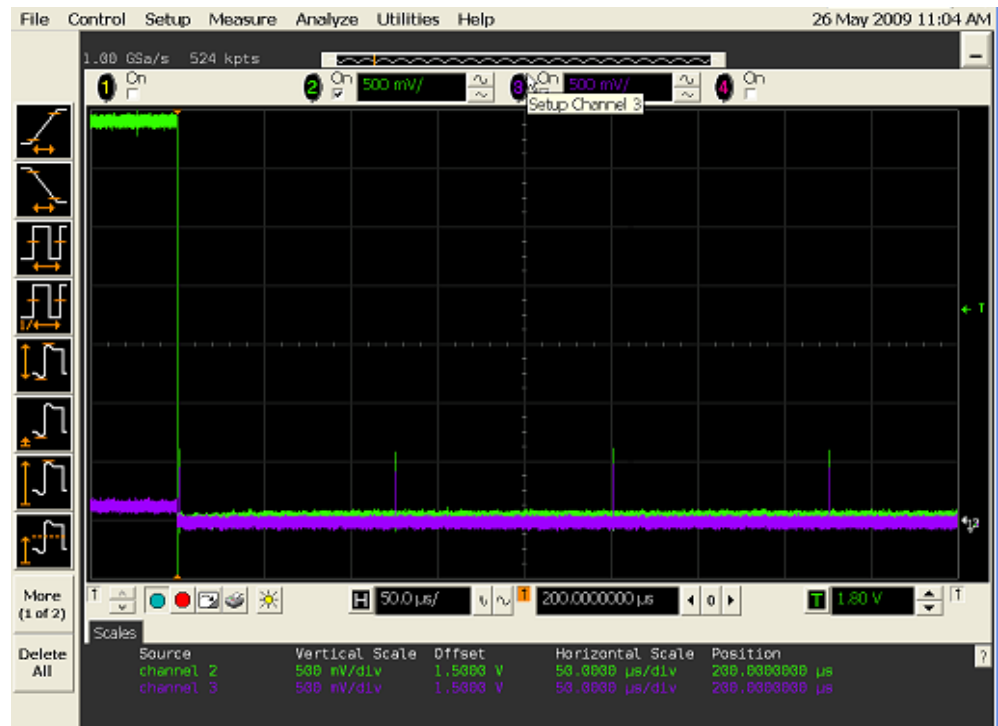
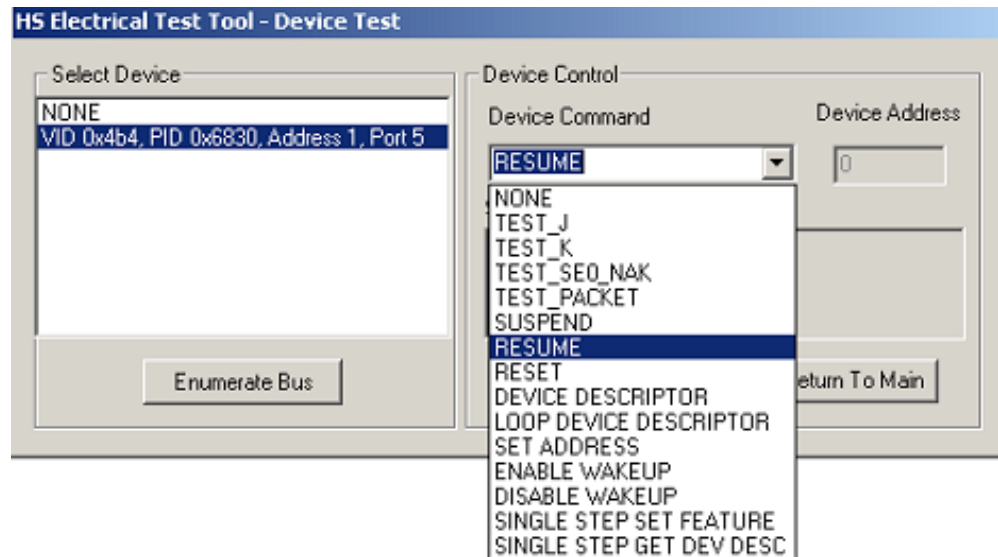

- 2 Click **OK** to close the Test Instructions dialog.

EL_27 Device CHIRP Response to Reset from Hi-Speed Operation

The USB automated test application will prompt you to perform these steps:

- 1 On the Device Test Menu of the HS Electrical Test Tool, select **RESET** from the Device Command drop down menu. Click **EXECUTE** once to reset the device operating in high speed. The captured transition should be as in the figure below.

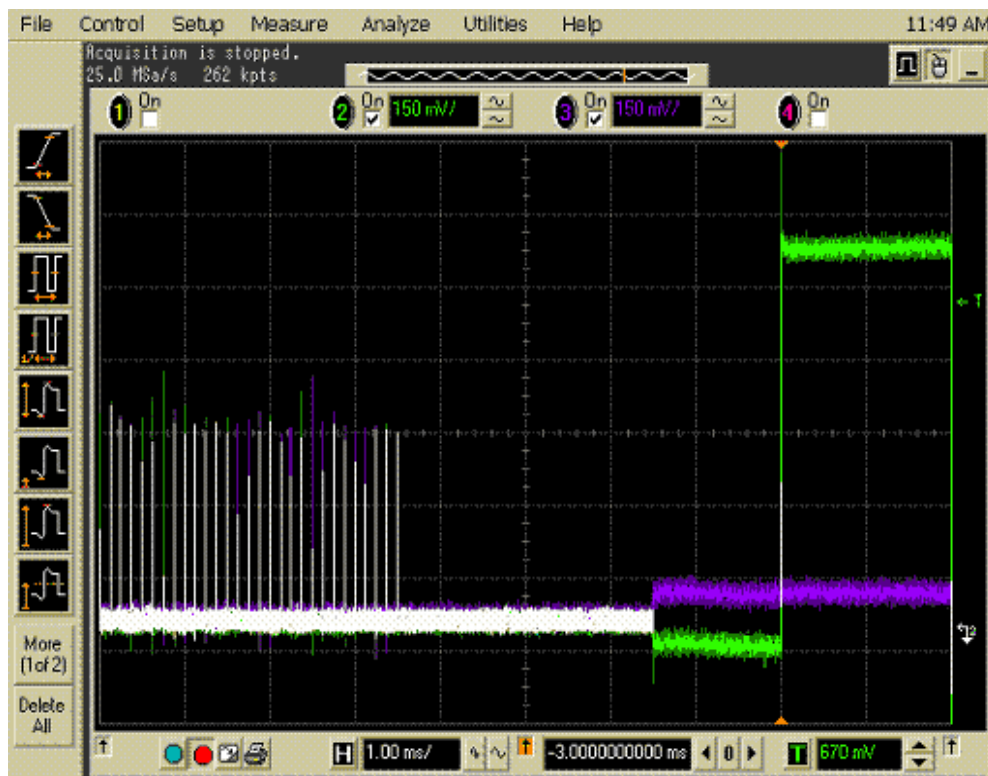
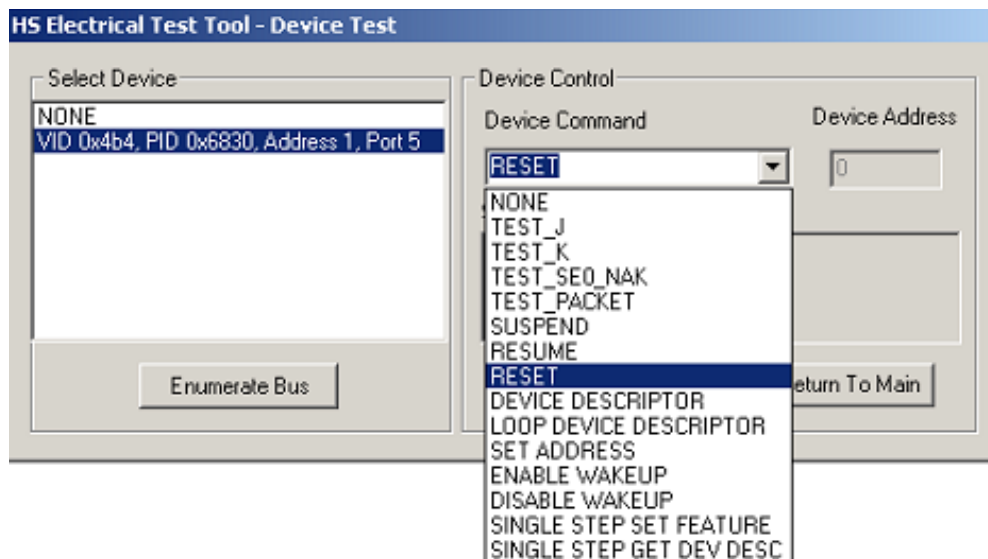

- 2 Click **OK** to close the Test Instructions dialog.

EL_28 Device CHIRP Response to Reset from Suspend

The USB automated test application will prompt you to perform these steps:

- 1 On the Device Test Menu of the HS Electrical Test Tool software, select **SUSPEND** from the Device Command drop down menu. Click **[EXECUTE]** once to place the device into suspend.

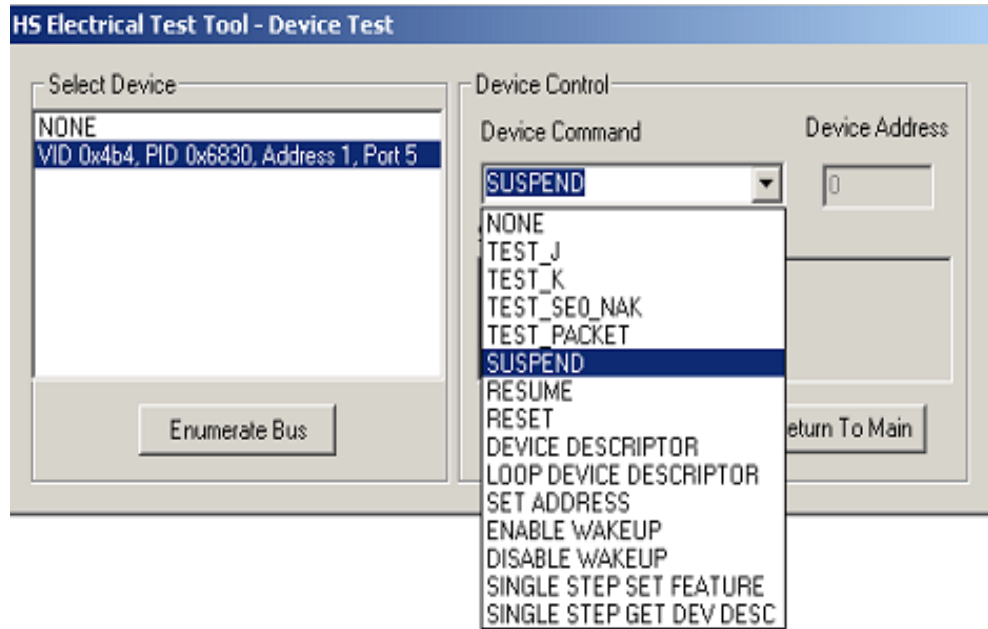

- 2 Click **OK** to close the Test Instructions dialog.

The USB automated test application will prompt you to perform these steps:

- 1 On the Device Test Menu of the HS Electrical Test Tool, select **RESET** from the Device Command drop down menu. Click **[EXECUTE]** once to reset the device operating in high speed. The captured transition should be as in the figure below.

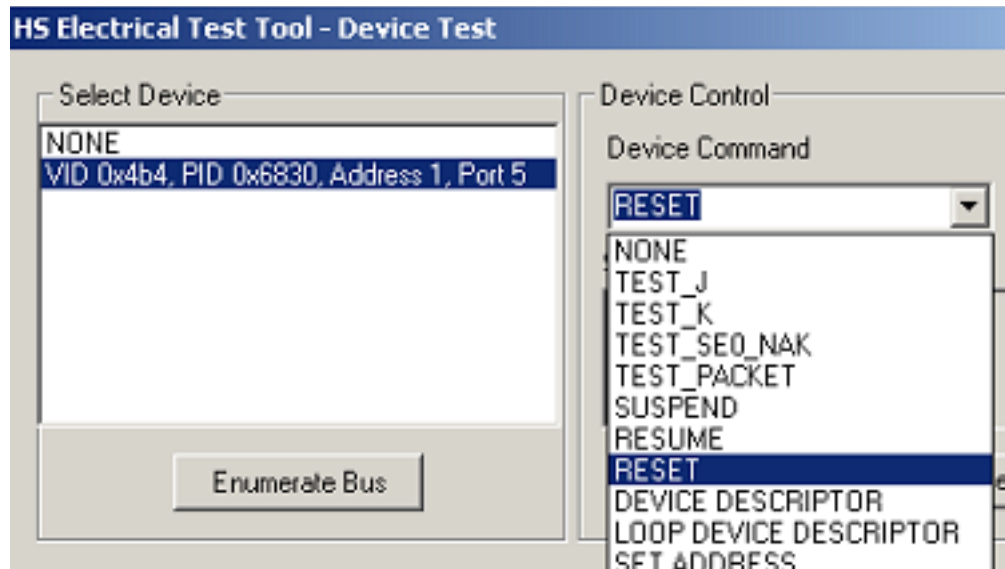

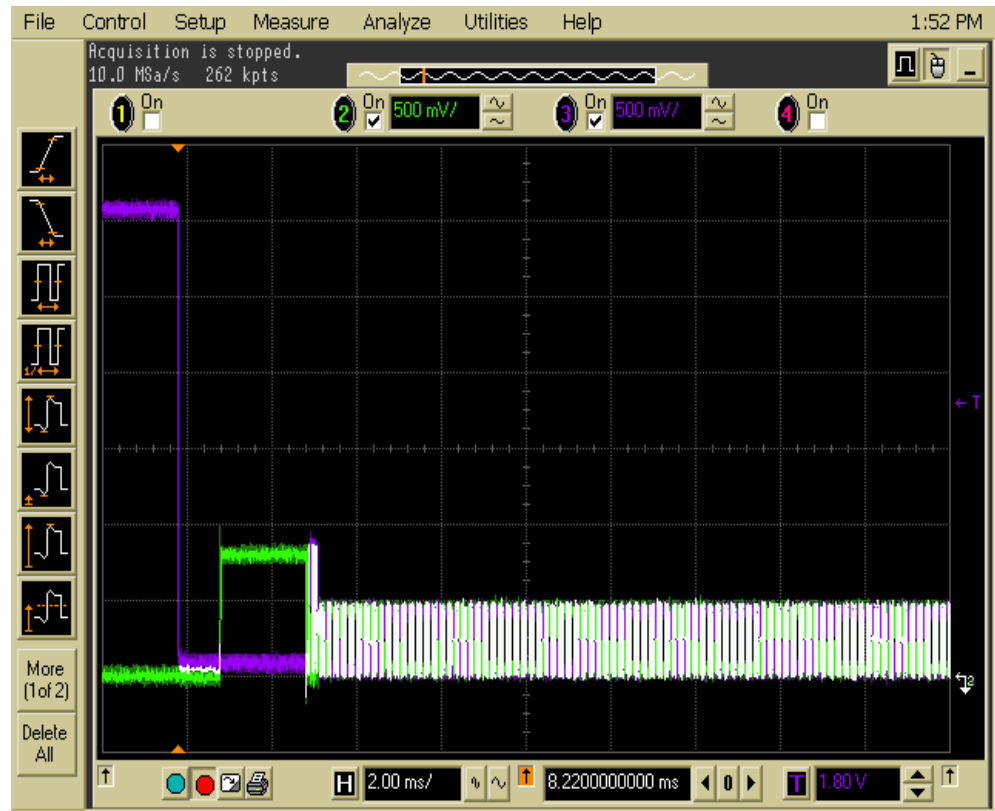

- 2 Click **OK** to close the Test Instructions dialog.

Viewing Test Results

- 1 When the Testing Complete dialog appears, click **OK**.
The Results tab shows the test results.

Device Test J/K, SEO_NAK

Equipment Used

Table 14 Equipment Used in Device Test J/K, SEO_NAK Tests

Quantity	Item	Description/Model
1	Digital Multimeter (DMM)	Keysight 34401A, 34461A, or equivalent
1	Host test bed computer	Any computer with hi-speed USB ports
1	Device Hi-Speed Signal Quality test fixture and 4" USB cable	Keysight E2666B
1	5V power supply	Keysight 8121-1966 or equivalent
1	5 meter USB 2.0 hi-speed cable	Any listed on USB-IF web site

Selecting the Tests

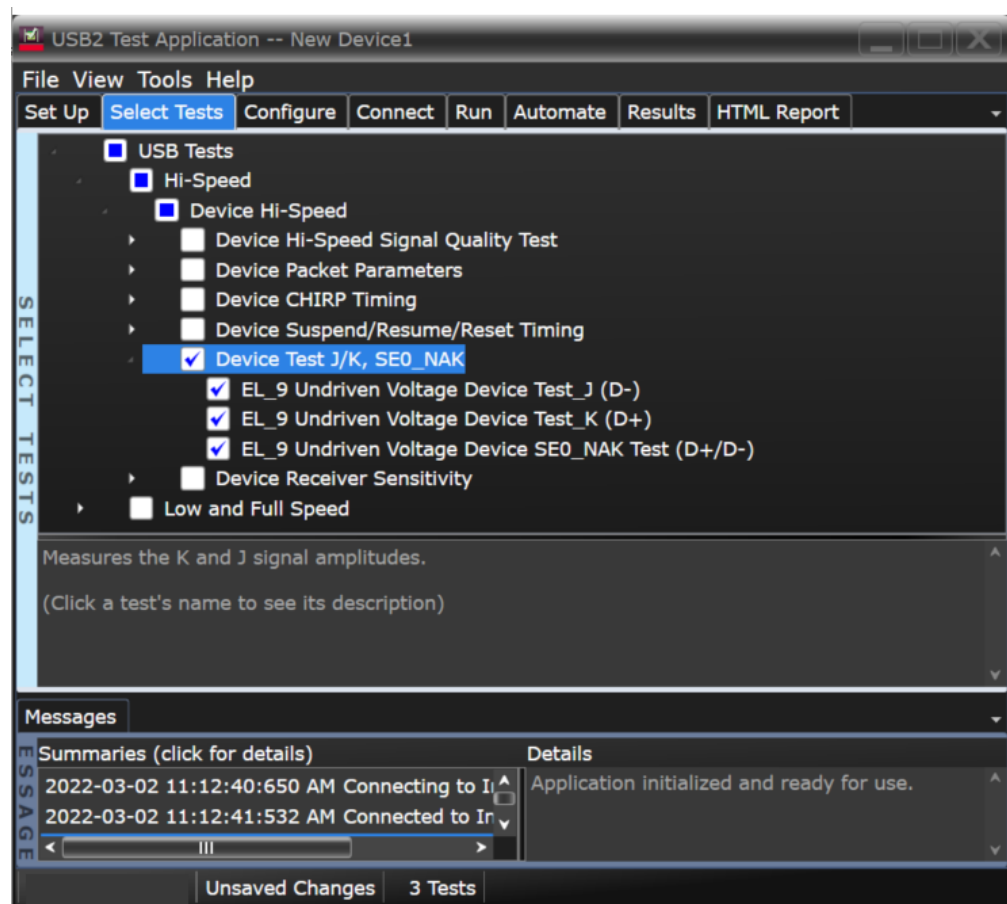

Configuring the Tests

Connecting the Equipment (Using Probe)

The USB automated test application will prompt you to perform these connection steps:

- 1 Attach the 5V power supply to J5 of the E2649-66401 (E2645-66507 if you are using the old fixture) Device High-Speed Signal Quality test fixture.
- 2 Place the switch in the test switch to **OFF** position. Verify the green Power LED is lit, and the yellow Test LED is off.
- 3 Connect the [TEST PORT] of the test fixture into the upstream facing port of the device under test, using the 4" USB cable.
- 4 Connect the [INIT PORT] of the test fixture to a port of the Test Bed Computer, using the 5 meter cable.
- 5 Connect Channel 1 to D+ and Channel 3 to D- using [SMA cable].

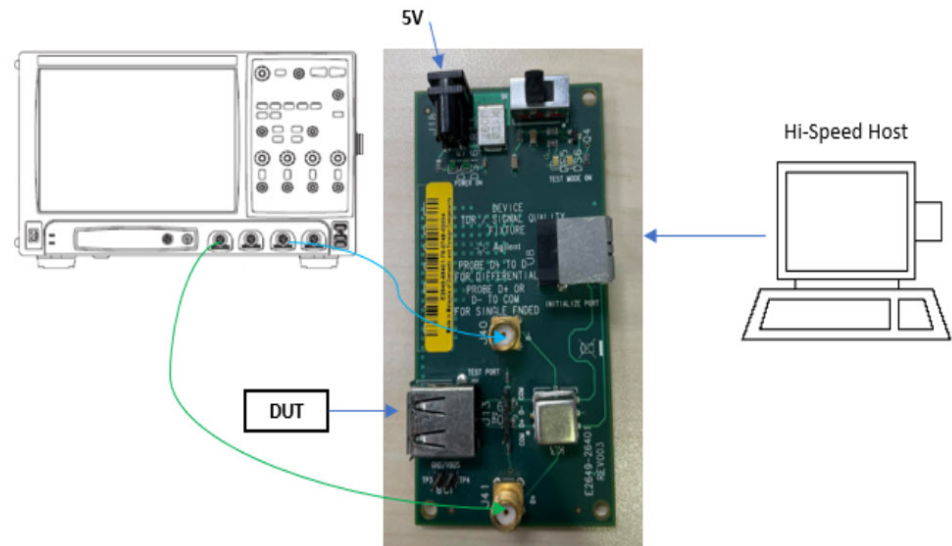

- 6 Check **I have completed these instructions.**

Connecting the Equipment (Using Voltmeter)

The USB automated test application will prompt you to perform these connection steps:

- 1 Attach the 5V power supply to J5 of the E2649-26401 (E2645-66507 if you are using the old test fixture) Device High-Speed Signal Quality test fixture.
- 2 Place the switch in the test switch to OFF position. Verify the green Power LED(D1) is lit, and the yellow Test LED(D2) is off.
- 3 Connect the [TEST PORT] of the test fixture into the upstream facing port of the device under test, using the 4" USB cable.
- 4 Connect the [INIT PORT] of the test fixture to a port of the Test Bed Computer, using the 5 meter cable.
- 5 Using a [Voltmeter] for voltage measurement.

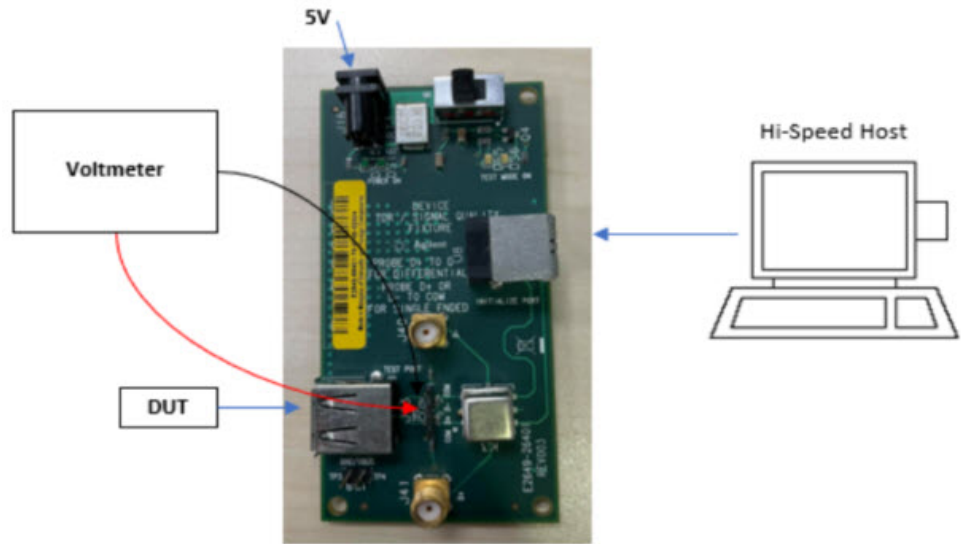

- 6 Check **I have completed these instructions.**

Running the Tests

- 1 Click **Run Tests.**

Test Instructions

EL_9 Undriven Voltage Device Test_J (D-) Test

The USB automated test application will prompt you to perform these steps:

- 1 On the Device Test Menu of the HS Electrical Test Tool, click [**Enumerate Bus**] once.
- 2 Select **TEST_J** from the Device Command drop down menu. Click [**EXECUTE**] once to place the device into TEST_J test mode.
- 3 Switch the test fixture into the **TEST** position.

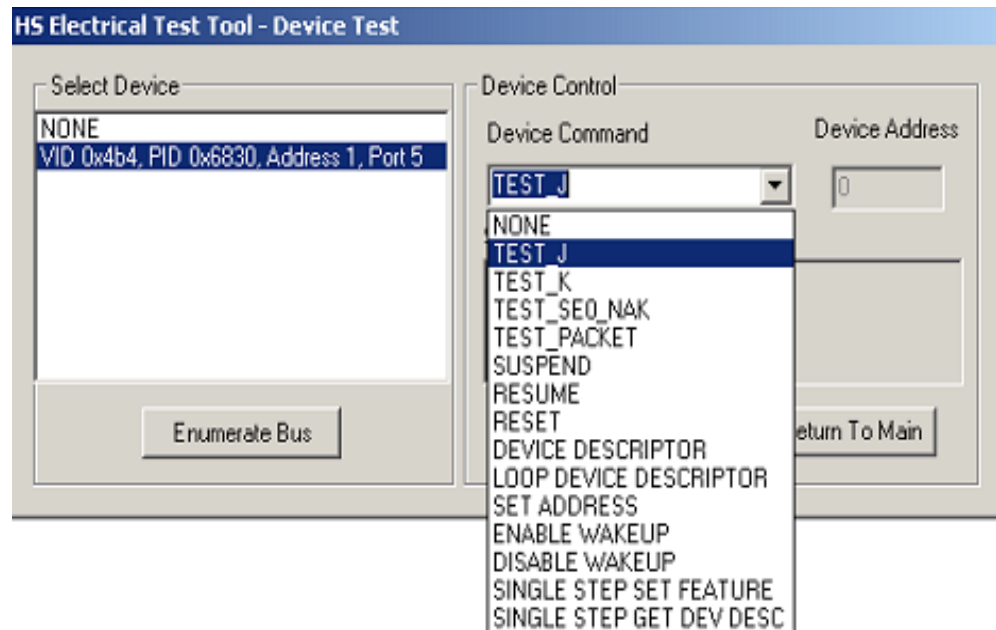

4 Click **OK** to close the Test Instructions dialog.

The USB automated test application will prompt you for the following voltage measurements:

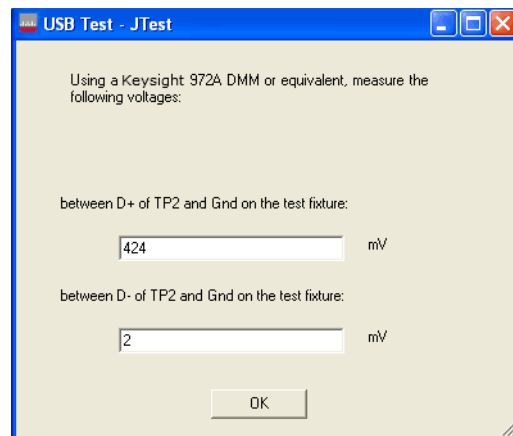

EL_9 Undriven Voltage Device Test_K (D+) Test

The USB automated test application will prompt you to perform these steps:

- 1 Return the Test switch of the test fixture to the **NORMAL** position.
- 2 Cycle the device power to restore the device to normal operation. On the Device Test Menu of the HS Electrical Test Tool, click [**Enumerate Bus**] once.
- 3 Select **TEST_K** from the Device Command drop down menu. Click [**EXECUTE**] once to place the device into TEST_K test mode.
- 4 Switch the test fixture into the **TEST** position.

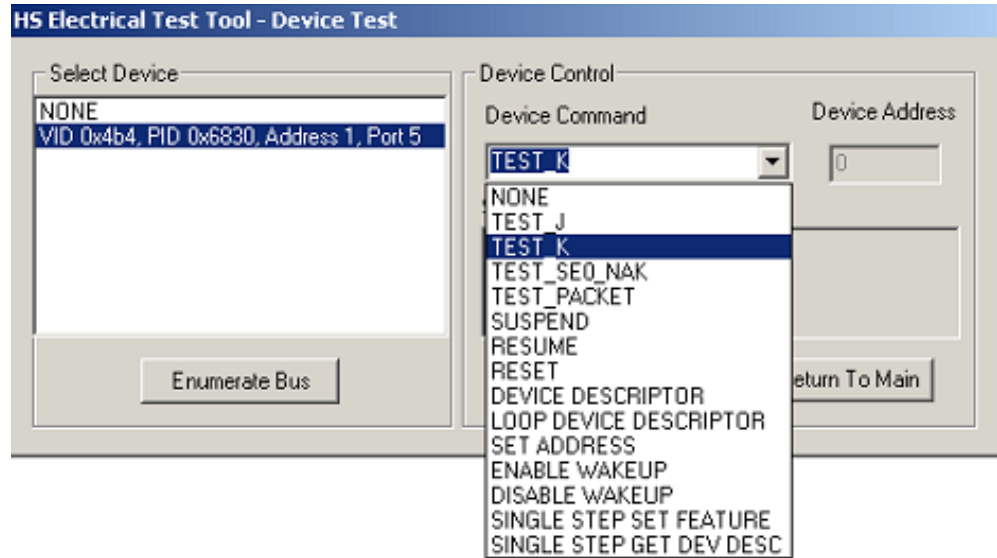

5 Click **OK** to close the Test Instructions dialog.

The USB automated test application will prompt you for the following voltage measurements:

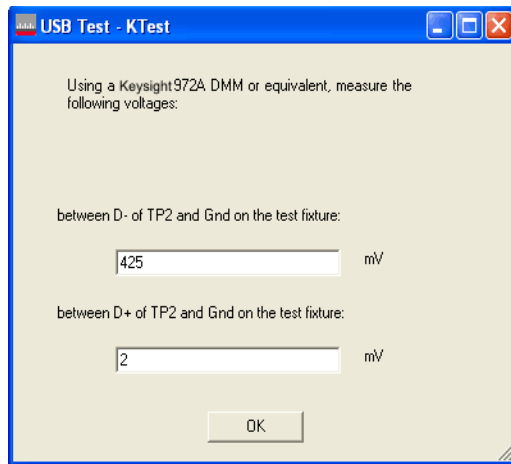

EL_9 Undriven Voltage Device SEO_NAK Test (D+/D-) Test

The USB automated test application will prompt you to perform these steps:

- 1 Return the Test switch of the test fixture to the **NORMAL** position.
- 2 Cycle the device power to restore the device to normal operation. On the Device Test Menu of the HS Electrical Test Tool, click [**Enumerate Bus**] once.
- 3 Select **TEST_SEO_NAK** from the Device Command drop down menu. Click [**EXECUTE**] once to place the device into TEST_SEO_NAK test mode.
- 4 Switch the test fixture into the **TEST** position.

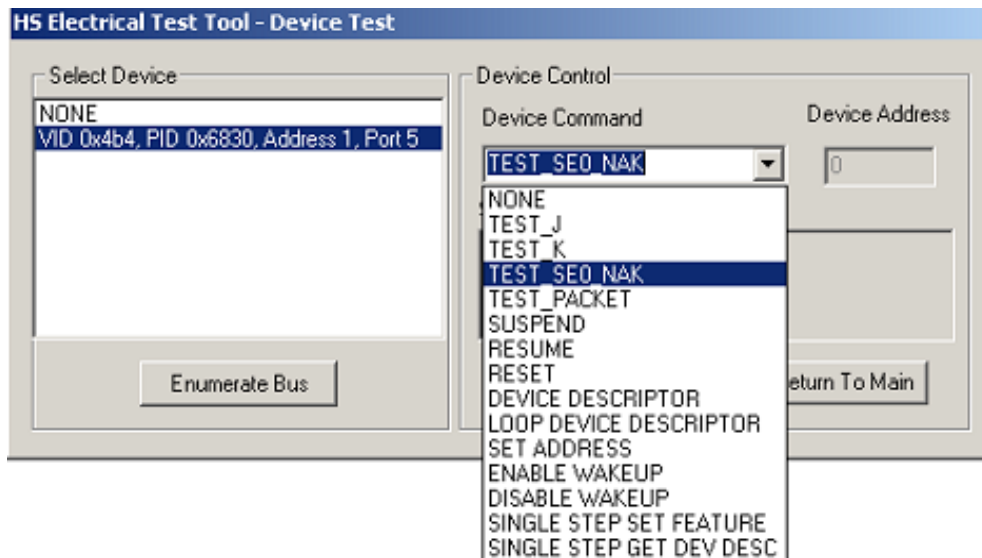

5 Click **OK** to close the Test Instructions dialog.

The USB automated test application will prompt you for the following voltage measurements:

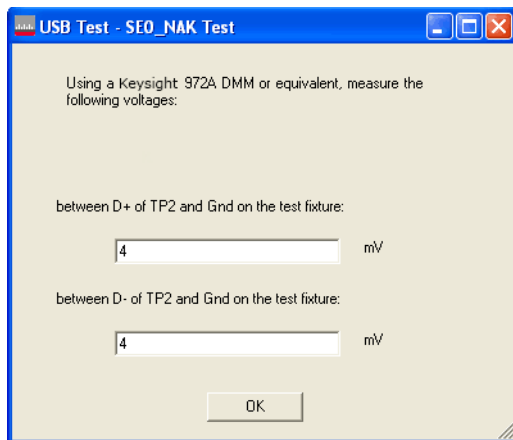

Viewing Test Results

- 1 When the Testing Complete dialog appears, click **OK**.
The Results tab shows the test results.

Device Receiver Sensitivity

Equipment Used

Table 15 Equipment Used in Device Receiver Sensitivity Tests

Quantity	Item	Description/Model
1	Oscilloscope	Keysight S-Series, 9000A, 90000A, MXR, or UXR Series
1	Probe type	Differential active (at least 2.5 GHz bandwidth) with E2678B socketed probe head
1	Header adapter (only needed if you are using the old test fixture - E2645-66503)	Keysight 01131-68703
1	Host test bed computer	Any computer with hi-speed USB ports
1	Receiver Sensitivity test fixture and 4" USB cable	Keysight E2649-66403 (old fixture P/N E2645-66503)
1	5V power supply	Keysight 8121-1966 or equivalent
1	Digital signal generator	Keysight 81160A (or 81134A with two 15433B transition time converters connected to the pulse generator outputs)
1	USB/GPIB interface	Keysight 82357B
2	6 dB attenuators	Keysight 8493C
2	50 ohm coaxial cable with male SMA connectors at both ends	Keysight 8120-4948 or equivalent
1	5 meter USB 2.0 hi-speed cable	Any listed on USB-IF web site

Selecting the Tests

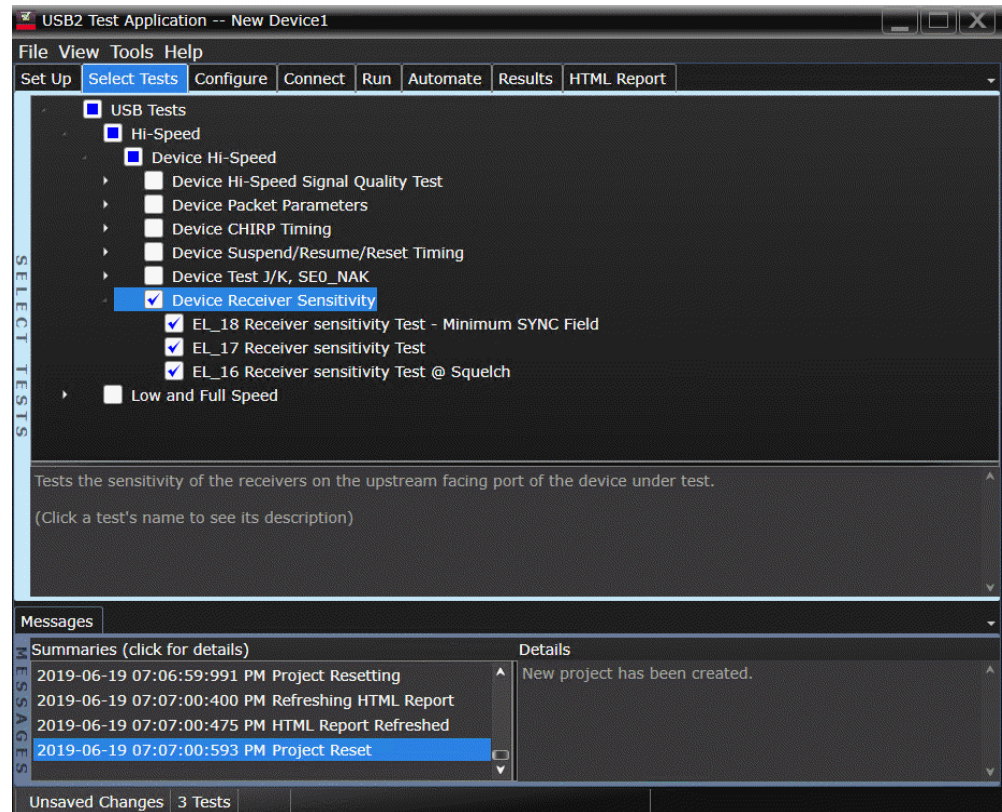

Configuring the Tests

If the pulse generator's SICL address is different from the default, make sure you set the 81134A/81160A Instrument Address configuration option to the pulse generator's SICL address.

See also ["Configuring the 81134A pulse generator using the 82357B GPIB-USB converter"](#) on page 107.

- 6 Connect OUTPUT1 to SMA1 (D+) of the E2649-26403 Device Receiver Sensitivity test fixture using the 8120-4948 SMA cables.
- 7 Connect OUTPUT2 to SMA2 (D-) of the E2649-26403 Device Receiver Sensitivity test fixture using the 8120-4948 SMA cables.

NOTE

If you are using E2649-26401/E2649-26402/E2649-26403/E2649-26404 you would not need to use the damped header adapter.

- 8 Check **I have completed these instructions.**

Running the Tests

- 1 Click **Run Tests.**

Test Instructions

The USB automated test application will prompt you to perform these steps:

- 1 Cycle the device power to restore the device to normal operation. On the Device Test Menu of the HS Electrical Test Tool, click **[Enumerate Bus]** button once to force enumeration of the newly connected device.
- 2 Select **TEST_SEO_NAK** from the Device Command drop down menu. Click **[EXECUTE]** once to place the device into TEST_SEO_NAK test mode.

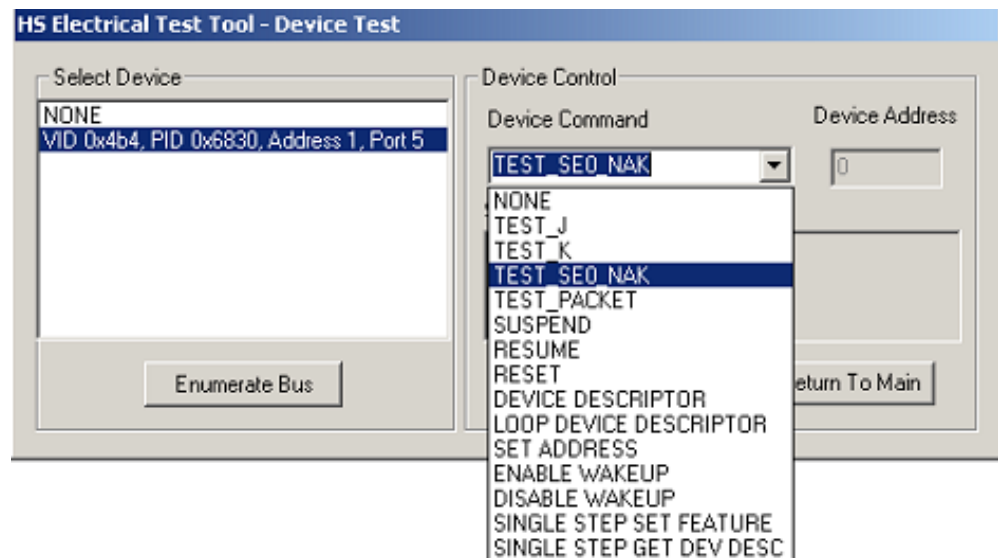

- 3 Place the test fixture Test Switch (S1) into the **TEST** position. This switches in the data generator in place of the host controller. The data generator emulates the "IN" packets from the host controller.

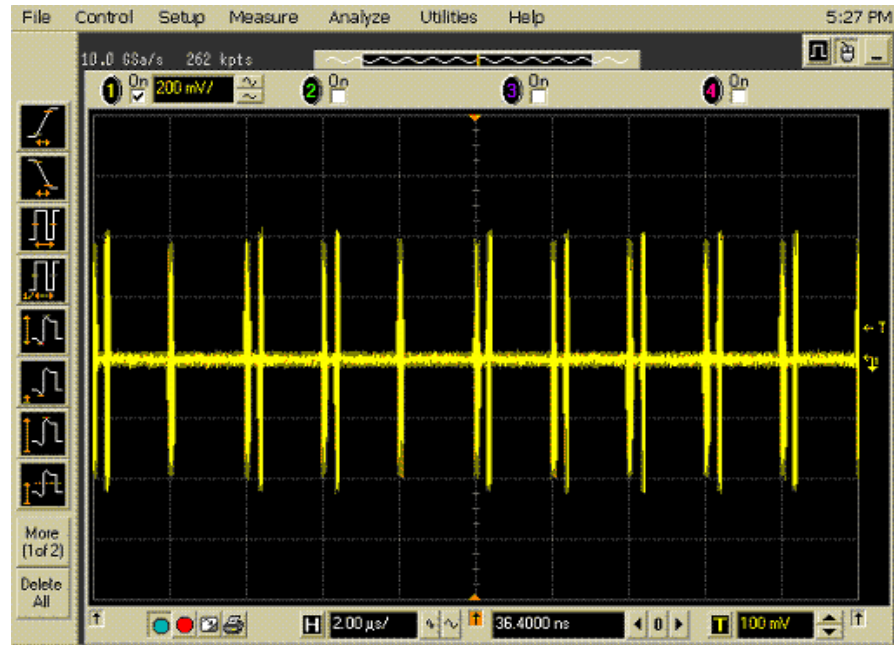

- 4 Click **OK** to close the Test Instructions dialog.

EL_18 Receiver sensitivity Test - Minimum SYNC Field

EL_17 Receiver sensitivity Test

EL_16 Receiver sensitivity Test @ Squelch

Viewing Test Results

- 1 When the Testing Complete dialog appears, click **OK**.
The Results tab shows the test results.

4 Hub Hi-Speed Tests

Hub Hi-Speed Signal Quality Test - Upstream Facing Ports	77
Hub Hi-Speed Signal Quality Test - Downstream Facing Ports	83
Hub Jitter Test - Downstream Facing Ports	87
Hub Packet Parameters - Upstream Facing Port	92
Hub Packet Parameters - Upstream Facing Port	92
Hub Packet Parameters - Downstream Facing Port	99
Hub Receiver Sensitivity - Upstream Facing Port	105
Hub Repeater Test - Downstream Facing Port	115
Hub Repeater Test - Upstream Facing Port	119
Hub CHIRP Timing - Upstream Facing Port	124
Hub Suspend/Resume/Reset Timing - Upstream Facing Port	128
Hub Test J/K, SEO_NAK - Upstream Facing Port	135
Hub Test J/K, SEO_NAK - Downstream Facing Port	142

NOTE

To give the automated test software more flexibility in making corner case measurements (and improve test performance), the oscilloscope's memory upgrade option is recommended (Option 001 when ordered with the oscilloscope, or after purchase: N5472A for the 90000A Series oscilloscopes).

In addition to the high-speed electrical tests prescribed in this chapter, the hub under test must also pass the following legacy electrical compliance tests applicable to the high-speed hub:

- Full speed signal quality – Upstream and downstream facing ports.
- Low speed signal quality – Downstream facing ports only.
- Inrush current – Upstream facing port only.
- Drop/Droop – Downstream facing ports.
- Back-voltage.

Before Running These Tests

If you haven't already performed the initial equipment set up, see "[Setting Up the Equipment](#)" on page 30.

Selecting the Hub Test Environment Setup

- 1 In the USB automated test application, select the **Hub** test environment.
- 2 To do automatic testing, select **USBET** as the **Test Method**. To do manual testing, select **Both** as the **Test Method**. See page 23 for more information.

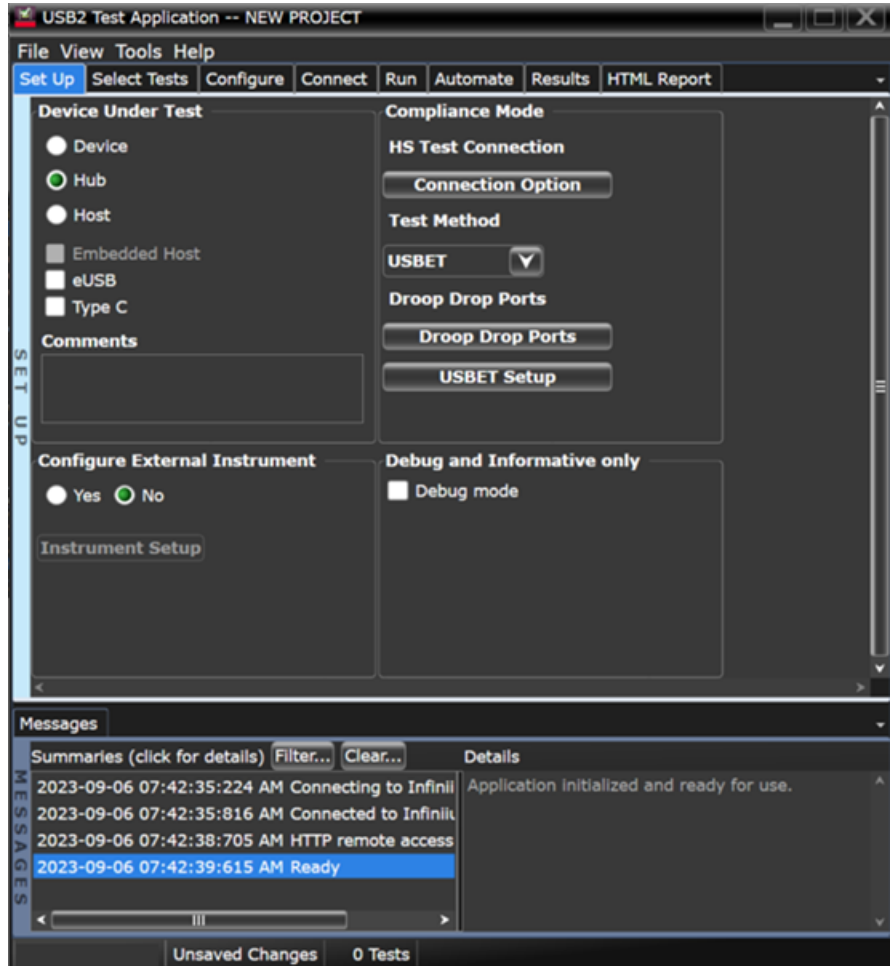

Hub Hi-Speed Signal Quality Test - Upstream Facing Ports

Equipment Used

Table 16 Equipment Used in Hub Hi-Speed Signal Quality Test - Upstream Facing Ports

Quantity	Item	Description/Model
1	Oscilloscope	Keysight S-Series, 9000A, 90000A, MXR, or UXR Series
1	Probe type	Differential active (at least 2.5 GHz bandwidth) with E2678B socketed probe head
1	Header adapter (only needed if you are using the old test fixture - E2645-66507)	Keysight 01131-68703
1	Host test bed computer	Any computer with hi-speed USB ports
1	Device Hi-Speed Signal Quality test fixture and 4" USB cable	Keysight E2666B
1	5V power supply	Keysight 8121-1966 or equivalent

Selecting the Tests

Note: To do manual testing, choose **Both** for the **Test Method** option under the **Set Up** tab. There will then be several manual tests to choose from under the **Select Test** tab.

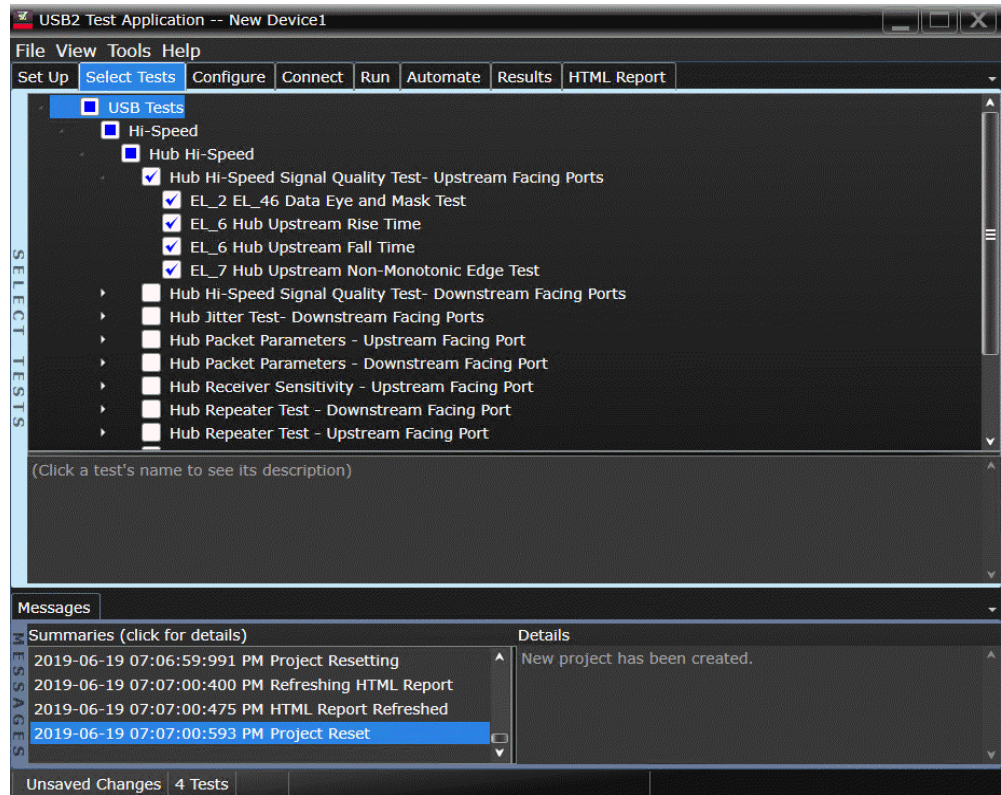

Configuring the Tests

Connecting the Equipment - Differential Connection

The USB automated test application will prompt you to perform these connection steps:

- 1 Attach the 5V power supply to J5 of the E2649-66401 (E2645-66507 if you are using the old fixture) Device Hi-Speed Signal Quality test fixture. Leave the TEST switch at the **OFF** position. Verify green Power LED is lit, and yellow test LED is off.
- 2 Connect the [TEST PORT] of the test fixture into the upstream facing port of the hub under test, using the 4" USB cable.
- 3 Connect the [INIT PORT] of the test fixture to a hi-speed port of the Test Bed Computer. Apply power to the hub.
- 4 Attach a differential probe to D+/D- of TP2 on the test fixture, using the header adapter (the header adapter is only needed if you are using the old test fixture). Ensure the + polarity on the probe lines up with D+ on the fixture.
- 5 If you are using the new fixture, please terminate the SMA connectors with 50 Ohm terminators.

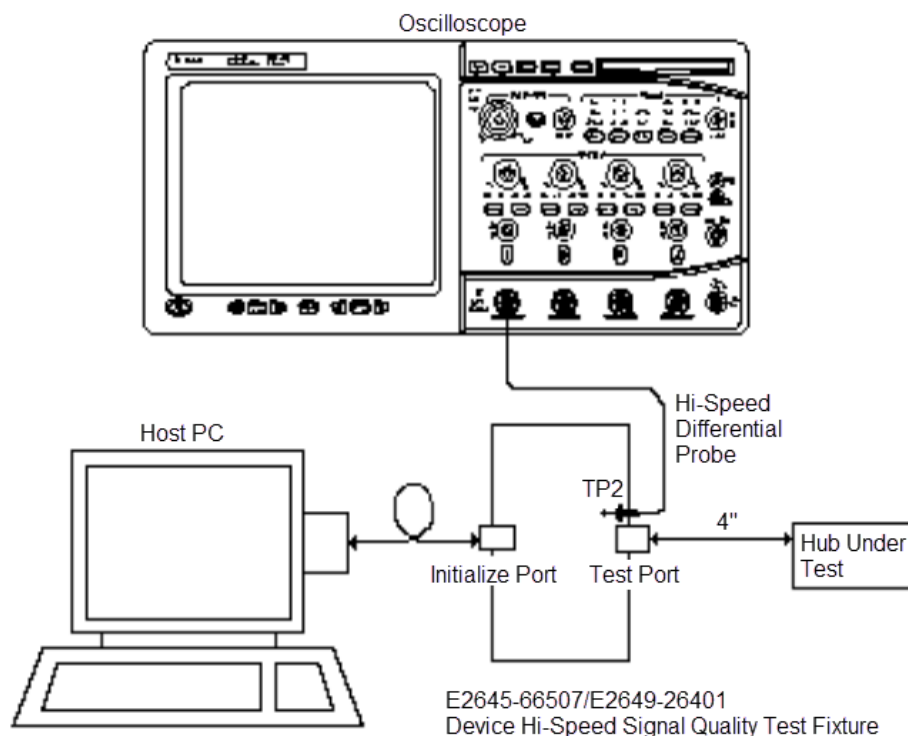

6 Check **I have completed these instructions.**

Connecting the Equipment - Single-Ended Connection.

- 1 Attach the 5V power supply to J5 of the E2649-26401 (E2645-66507 if you are using the old test fixture) Device Hi-Speed Signal Quality test fixture. Leave the TEST switch at the OFF position. Verify green Power LED (D1) is lit, and yellow test LED (D2) is off.
- 2 Connect the [TEST PORT] of the test fixture into the upstream facing port of the hub under test, using the 4" USB cable.
- 3 Connect the [INIT PORT] of the test fixture to a hi-speed port of the Test Bed Computer, using a USB cable. Apply power to the hub.
- 4 Attach the SMA cables on undefined and undefined to SMA connectors D+ and D- of the test fixture.

NOTE

1. Single-ended connection is only available using E2649-26401/E2649-26402/E2649-26403.
2. If you are using differential connection test connections for E2649-26401/E2649-26402/E2649-26403, please terminate the SMA connector with 50 Ohm terminators.

- 5 Attach the SMA cables to the SMA connectors D+ and D- of TP2 on the test fixture.

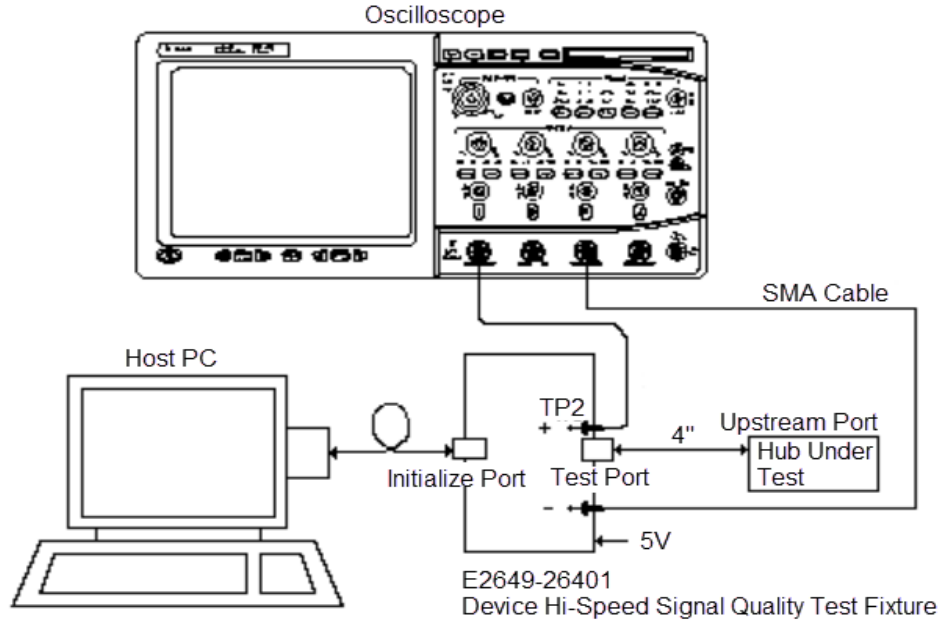

- 6 Check **I have completed these instructions.**

Running the Tests

- 1 Click **Run Tests.**

Test Instructions, Part 1

The USB automated test application will prompt you to perform these steps:

- 1 Invoke the HS Electrical Test Tool software on the Hi-Speed Electrical Test Bed computer. Select **Hub** and click the **[TEST]** button to enter the Hub Test menu.

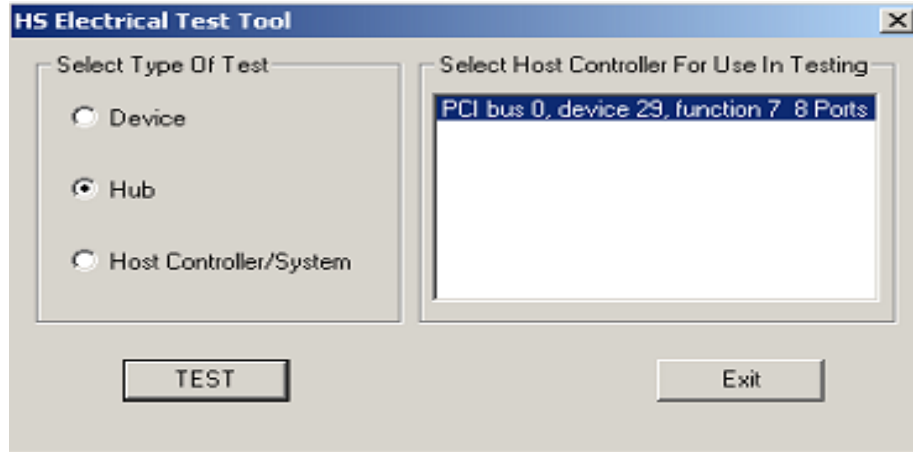

- 2 The hub under test should be enumerated with the hub's VID shown together with the USB address. Select **[TEST_PACKET]** from the Hub Command drop down menu and click **[EXECUTE]**.

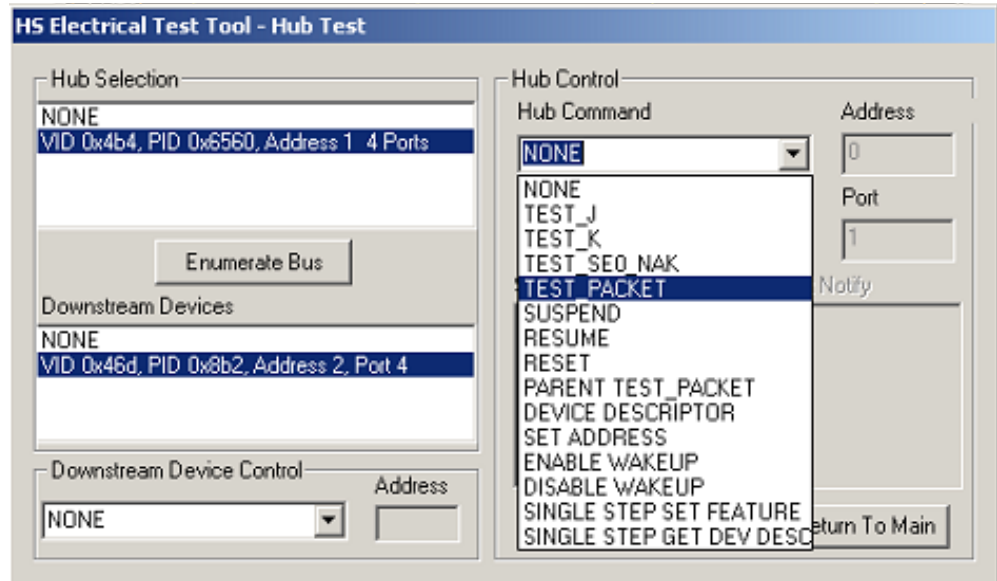

- 3 Click **OK** to close the Test Instructions dialog.

Test Instructions, Part 2

The USB automated test application will prompt you to perform these steps:

- 1 Place the Test Switch (S1) of the test fixture in the **TEST** position. Verify the yellow TEST LED is lit. You should see the transmitted test packet on the oscilloscope as below.

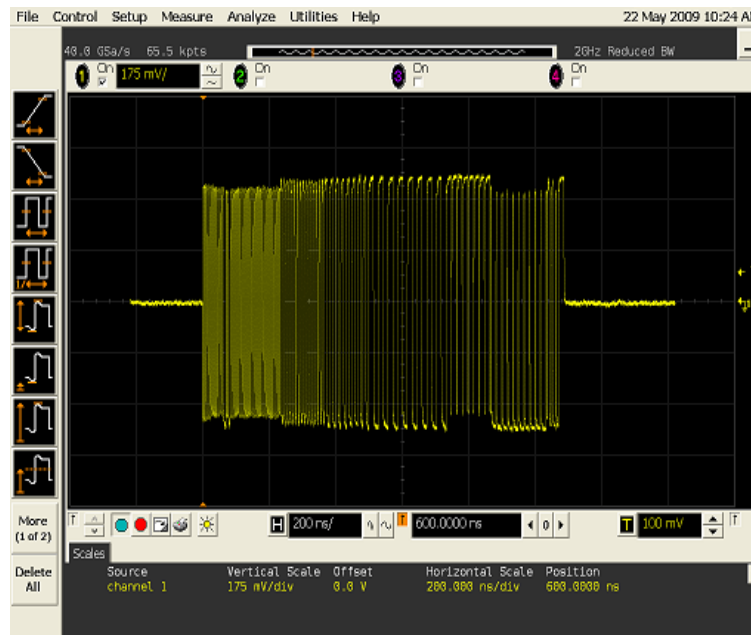

- 2 Click **OK** to close the Test Instructions dialog.

EL_6 Rise Time

EL_6 Fall Time

EL_2 EL_46 Data Eye and Mask Test

After viewing the test results, click **OK** to close the Test Instructions dialog.

EL_7 Non-Monotonic Edge Test

Viewing Test Results

- 1 When the Testing Complete dialog appears, click **OK**.
The Results tab shows the test results.

Hub Hi-Speed Signal Quality Test - Downstream Facing Ports

Equipment Used

Table 17 Equipment Used in Hub Hi-Speed Signal Quality Test - Downstream Facing Ports

Quantity	Item	Description/Model
1	Oscilloscope	Keysight S-Series, 9000A, 90000A, MXR, or UXR Series
1	Probe type	Differential active (at least 2.5 GHz bandwidth) with E2678B socketed probe head
1	Header adapter (only needed if you are using the old test fixture - E2645-66508)	Keysight 01131-68703
1	Host test bed computer	Any computer with hi-speed USB ports
1	Host Hi-Speed Signal Quality test fixture and 4" USB cable	Keysight E2649-66402 (olf fixture P/N E2645-66508)
1	5V power supply	Keysight 8121-1966 or equivalent

Selecting the Tests

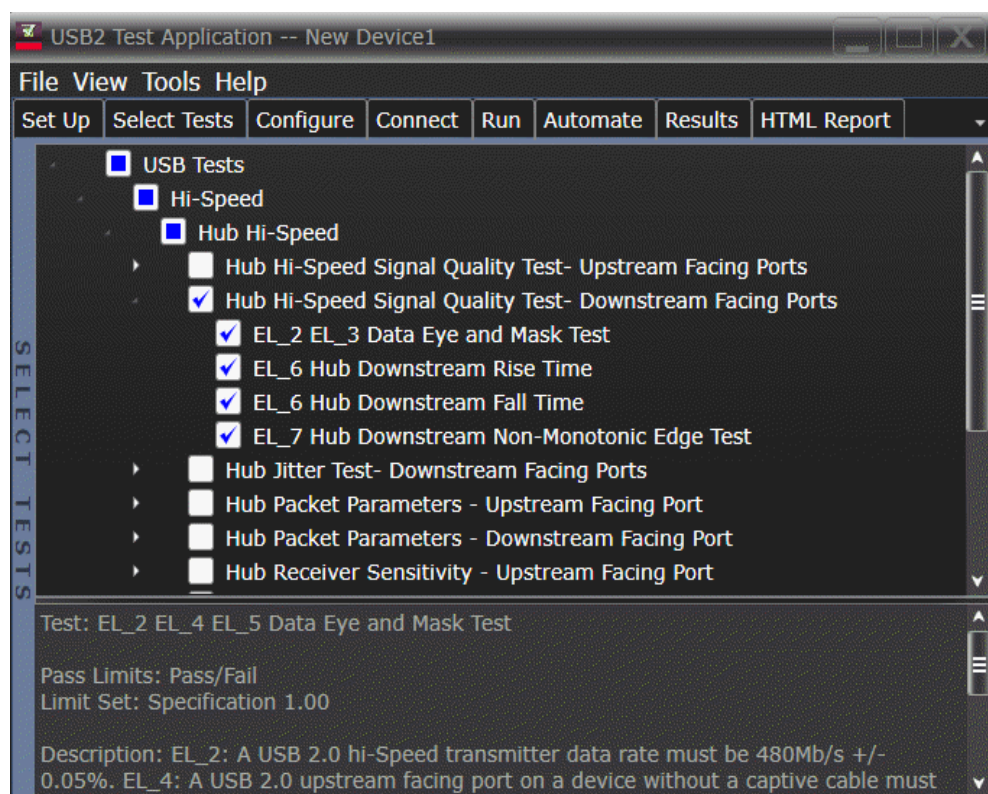

Configuring the Tests

Connecting the Equipment - Differential Connection

The USB automated test application will prompt you to perform these connection steps:

- 1 Attach the 5V power supply to J5 of the E2649-26402 (E2645-66508 if you are using the old test fixture) Hi-Speed Signal Quality test fixture and verify the green Power LED (D1) is lit.
 - a Set the Test switch (S1) of the test fixture to TEST and verify the yellow TEST LED is lit.
- 2 Attach the differential probe on Channel 1 to D+ and D- of TP2 of the test fixture, using a damped header adapter.
- 3 Connect the upstream port of the hub to a high-speed root port of the test bed computer.
- 4 Connect the [TEST PORT] of the test fixture into the downstream facing port under the test of the hub using a 4 inch USB cable. Apply power to the hub.

NOTE

1. Single-ended connection is only available using E2649-26401/E2649-26402/E2649-26403.
2. If you are using differential connection test connections for E2649-26401/E2649-26402/E2649-26403 , please terminate the SMA connector with 50 Ohm terminators.

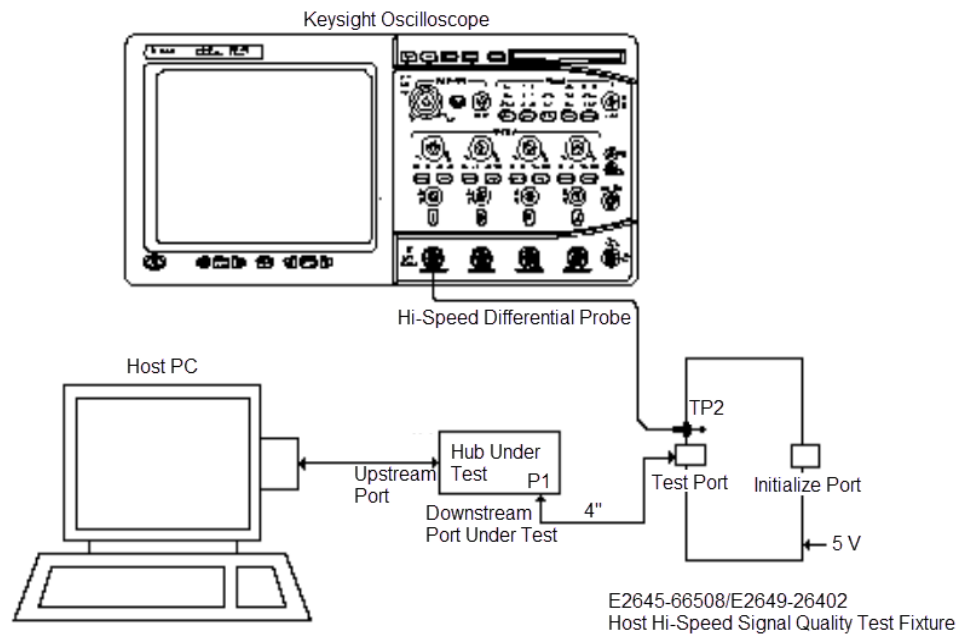

- 5 Check **I have completed these instructions.**

Connecting the Equipment - SingleEnded Connection

The USB automated test application will prompt you to perform these connection steps:

- 1 Attach the 5V power supply to J5 of the E2649-26402 (E2645-66508 if you are using the old test fixture) Hi-Speed Signal Quality test fixture and verify the green Power LED (D1) is lit.
 - a Set the Test switch (S1) of the test fixture to TEST and verify the yellow TEST LED is lit.
- 2 Attach the SMA cables on undefined and undefined to D+ and D- on the test fixture respectively.
- 3 Connect the upstream port of the hub to a high-speed root port of the test bed computer.
- 4 Connect the [TEST PORT] of the test fixture into the downstream facing port under the test of the hub using a 4 inch USB cable. Apply power to the hub.

NOTE

1. Single-ended connection is only available using E2649-26401/E2649-26402/E2649-26403.
2. If you are using differential connection test connections for E2649-26401/E2649-26402/E2649-26403, please terminate the SMA connector with 50 Ohm terminators.

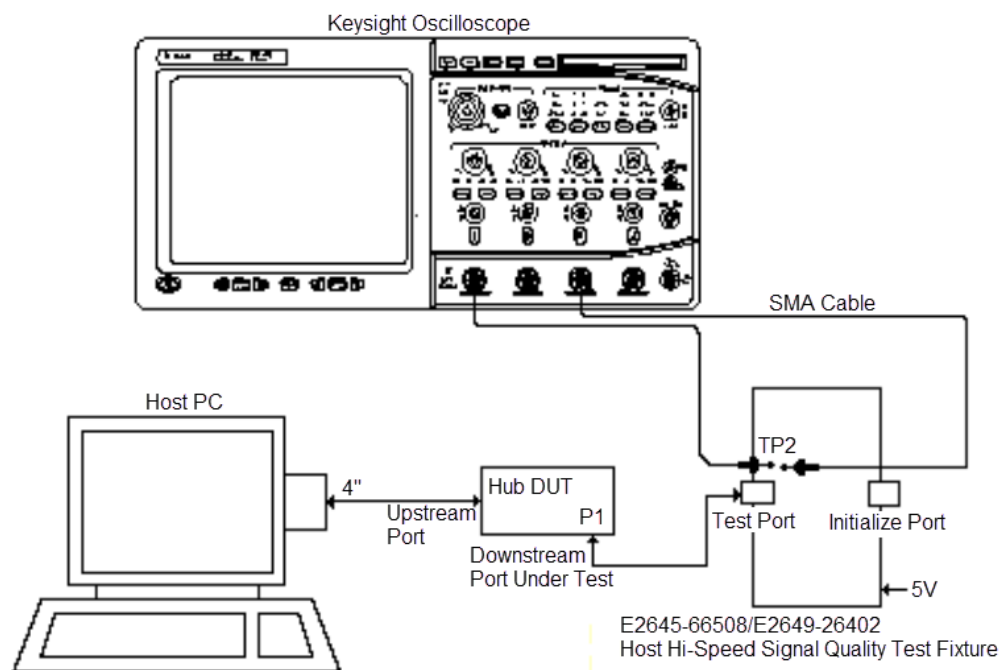

- 5 Check **I have completed these instructions.**

Running the Tests

- 1 Click **Run Tests.**

Test Instructions

The USB automated test application will prompt you to perform these steps:

- 1 On the Hub Test menu of the HS Electrical Test Tool, click the **[Enumerate Bus]** button once. The hub under test should be enumerated with the hub's VID shown together with the USB address.
- 2 Select **TEST_PACKET** from the Port Control drop down menu.
- 3 Enter the port number of the hub port being tested and click **[EXECUTE]**.

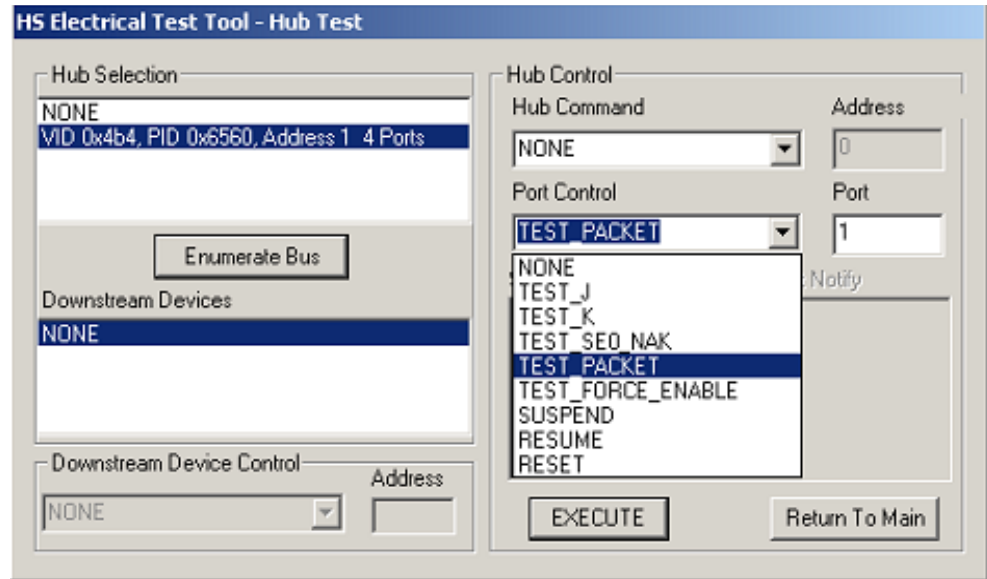

- 4 Click **OK** to close the Test Instructions dialog.

EL_6 Rise Time

EL_6 Fall Time

EL_2 EL_3 Data Eye and Mask Test

After viewing the test results, click **OK** to close the Test Instructions dialog.

EL_7 Non-Monotonic Edge Test

Viewing Test Results

- 1 When the Testing Complete dialog appears, click **OK**.
The Results tab shows the test results.

Hub Jitter Test - Downstream Facing Ports

Equipment Used

Table 18 Equipment Used in Hub Jitter Test - Downstream Facing Ports

Quantity	Item	Description/Model
1	Oscilloscope	Keysight S-Series, 9000A, 90000A, MXR, or UXR Series
1	Probe type	Differential active (at least 2.5 GHz bandwidth) with E2678B socketed probe head
1	Header adapter (only needed if you are using the old test fixture - E2645-66508)	Keysight 01131-68703
1	Host test bed computer	Any computer with hi-speed USB ports
1	Host Hi-Speed Signal Quality test fixture and 4" USB cable	Keysight E2649-66402 (old fixture P/N E2645-66508)
1	5V power supply	Keysight 8121-1966 or equivalent

Selecting the Tests

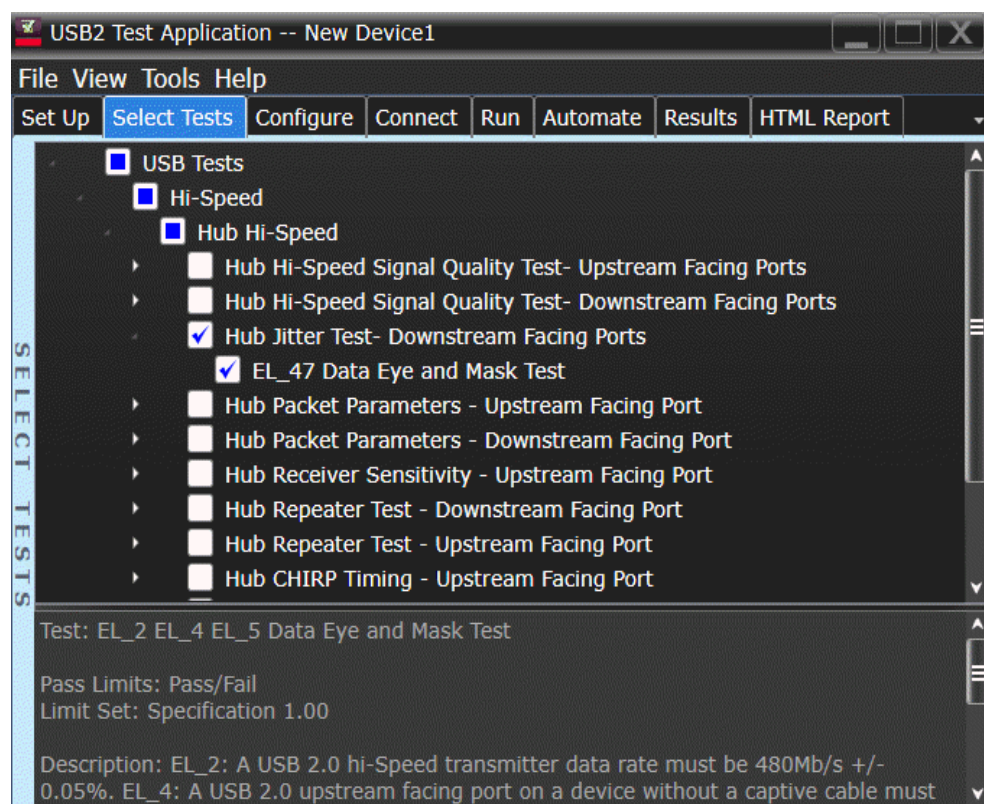

Configuring the Tests

Connecting the Equipment - Differential Connection

The USB automated test application will prompt you to perform these connection steps:

- 1 Attach the 5V power supply to J5 of the E2649-26402 (E2645-66508 if you are using the old test fixture) Hi-Speed Signal Quality test fixture and verify the green Power LED (D1) is lit.
 - a Set the Test switch (S1) of the test fixture to TEST and verify the yellow TEST LED is lit.
- 2 Attach a differential probe on Channel 1 to D+ and D- of TP2 of the test fixture, using a damped header adapter.
- 3 Connect the upstream port of the hub to a high-speed root port of the test bed computer.
- 4 Connect the [TEST PORT] of the test fixture into the downstream facing port under the test of the hub using a 4 inch USB cable. Apply power to the hub.

NOTE

1. Single-ended connection is only available using E2649-26401/E2649-26402/E2649-26403.
2. If you are using differential connection test connections for E2649-26401/E2649-26402/E2649-26403, please terminate the SMA connector with 50 Ohm terminators.

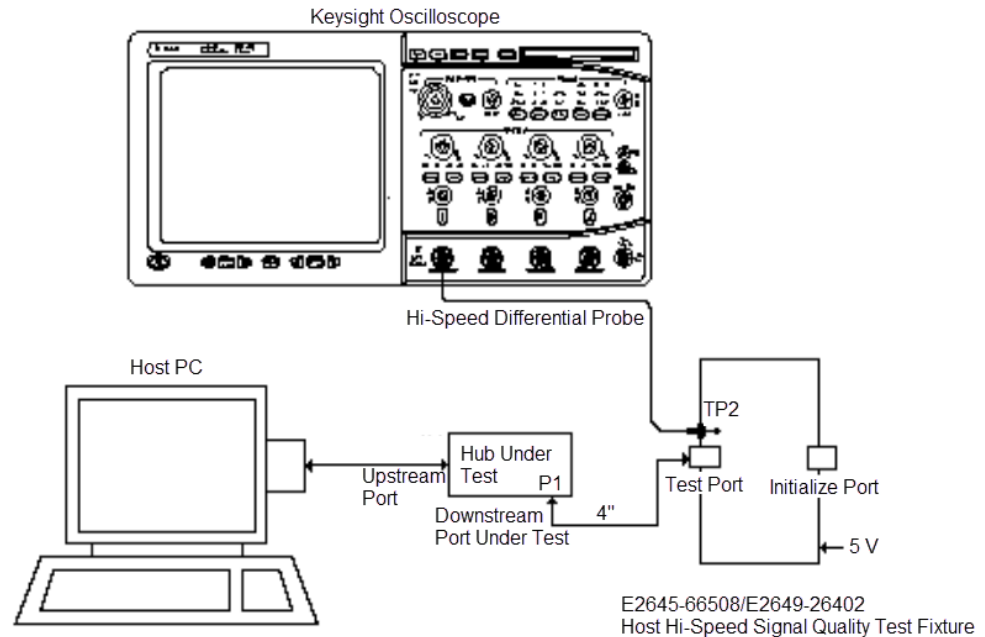

- 5 Check **I have completed these instructions.**

Connecting the Equipment - SingleEnded Connection

The USB automated test application will prompt you to perform these connection steps:

- 1 Attach the 5V power supply to J5 of the E2649-26402 (E2645-66508 if you are using the old test fixture) Hi-Speed Signal Quality test fixture and verify the green Power LED (D1) is lit.
 - a Set the Test switch (S1) of the test fixture to TEST and verify the yellow TEST LED is lit.
- 2 Attach the SMA cables on undefined and undefined to D+ and D- on the test fixture respectively.
- 3 Connect the upstream port of the hub to a high-speed root port of the test bed computer.
- 4 Connect the [TEST PORT] of the test fixture into the downstream facing port under the test of the hub using a 4 inch USB cable. Apply power to the hub.

NOTE

1. Single-ended connection is only available using E2649-26401/E2649-26402/E2649-26403.
2. If you are using differential connection test connections for E2649-26401/E2649-26402/E2649-26403, please terminate the SMA connector with 50 Ohm terminators.

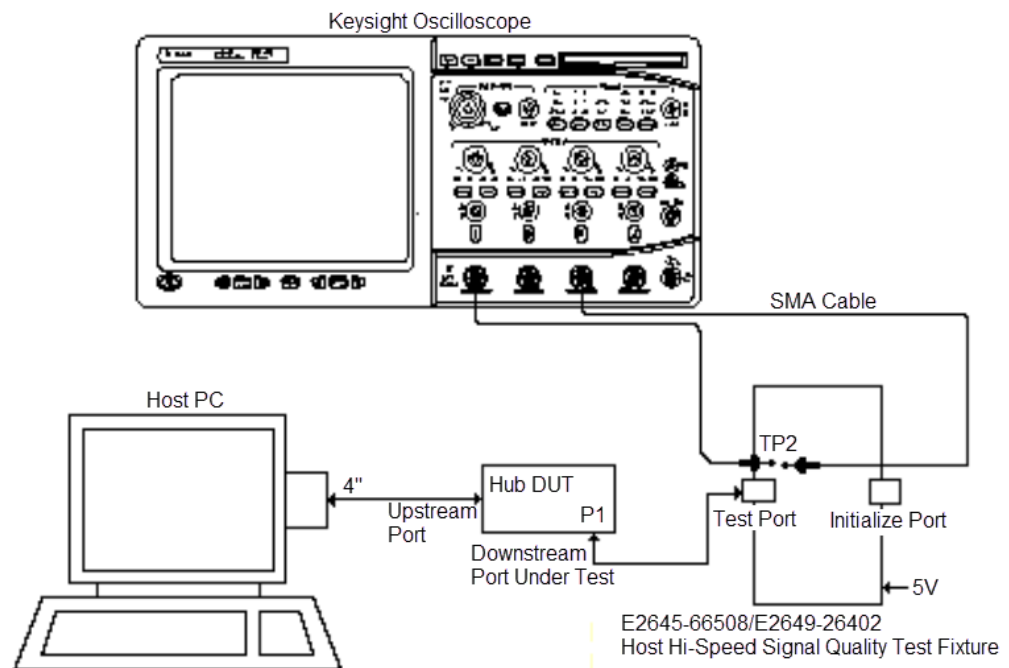

- 5 Check **I have completed these instructions.**

Running the Tests

- 1 Click **Run Tests.**

Test Instructions

EL_47 Data Eye and Mask Test

The USB automated test application will prompt you to perform these steps:

- 1 On the Hub Test menu of the HS Electrical Test Tool, click **[Enumerate Bus]** once.
- 2 Select **TEST_FORCE_ENABLE** from the Port Control drop down menu.
- 3 Enter the port number of the hub port being tested and click **[EXECUTE]** once to force-enable the hub port under test.

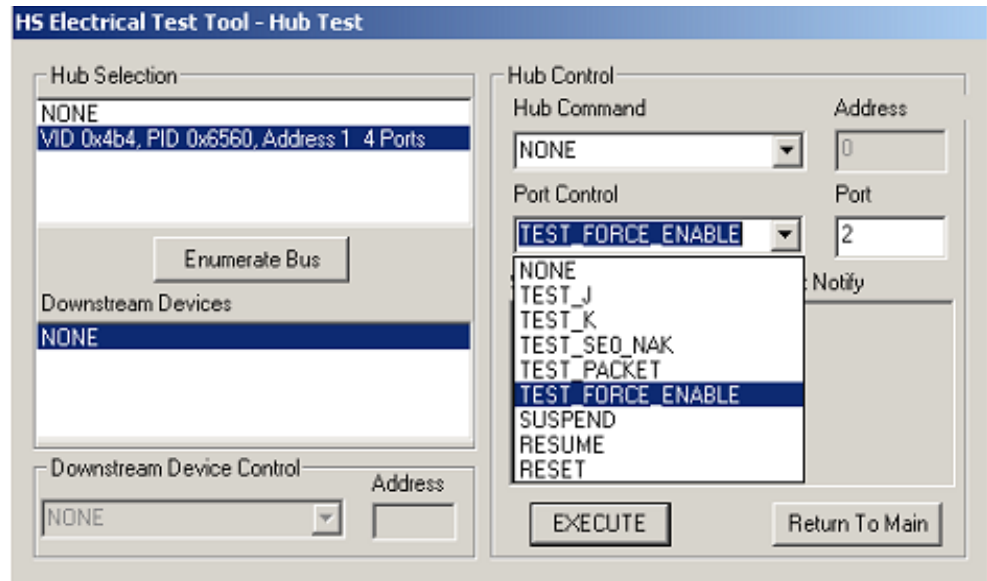

- 4 Select **PARENT TEST_PACKET** from the Hub Command drop down menu and click **[EXECUTE]**.

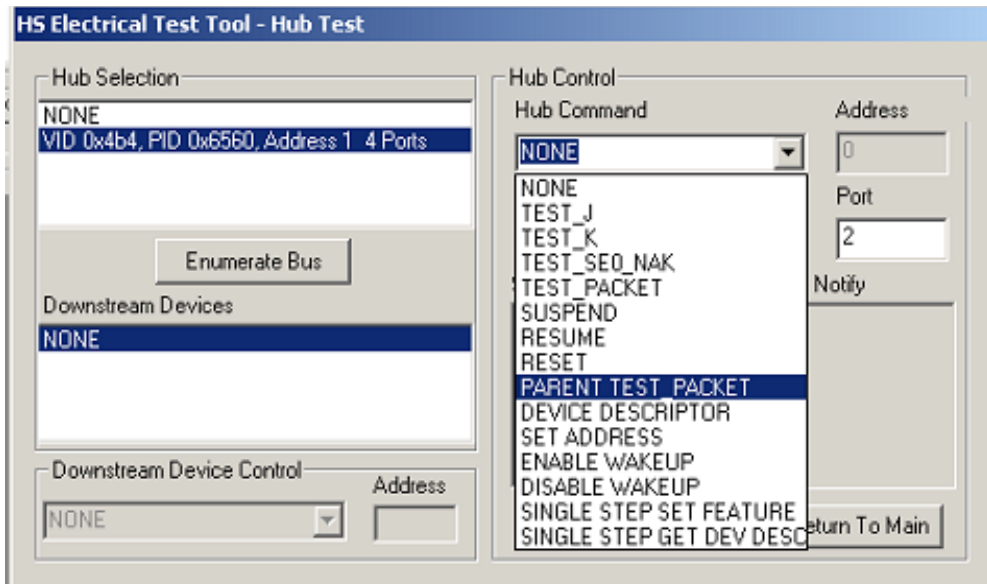

- 5 Click **OK** to close the Test Instructions dialog.

After viewing the test results, click **OK** to close the Test Instructions dialog.

Viewing Test Results

- 1 When the Testing Complete dialog appears, click OK.
The Results tab shows the test results.

Hub Packet Parameters - Upstream Facing Port

Equipment Used

Table 19 Equipment Used in Hub Packet Parameters - Upstream Facing Port

Quantity	Item	Description/Model
1	Oscilloscope	Keysight S-Series, 9000A, 90000A, MXR, or UXR Series
1	Probe type	Differential active (at least 2.5 GHz bandwidth) with E2678B socketed probe head
1	Header adapter (only needed if you are using the old test fixture - E2645-66507)	Keysight 01131-68703
1	Host test bed computer	Any computer with hi-speed USB ports
1	Device Hi-Speed Signal Quality test fixture and 4" USB cable	Keysight E2649-66401 (old fixture P/N E2645-66507)
1	5V power supply	Keysight 8121-1966 or equivalent

Selecting the Tests

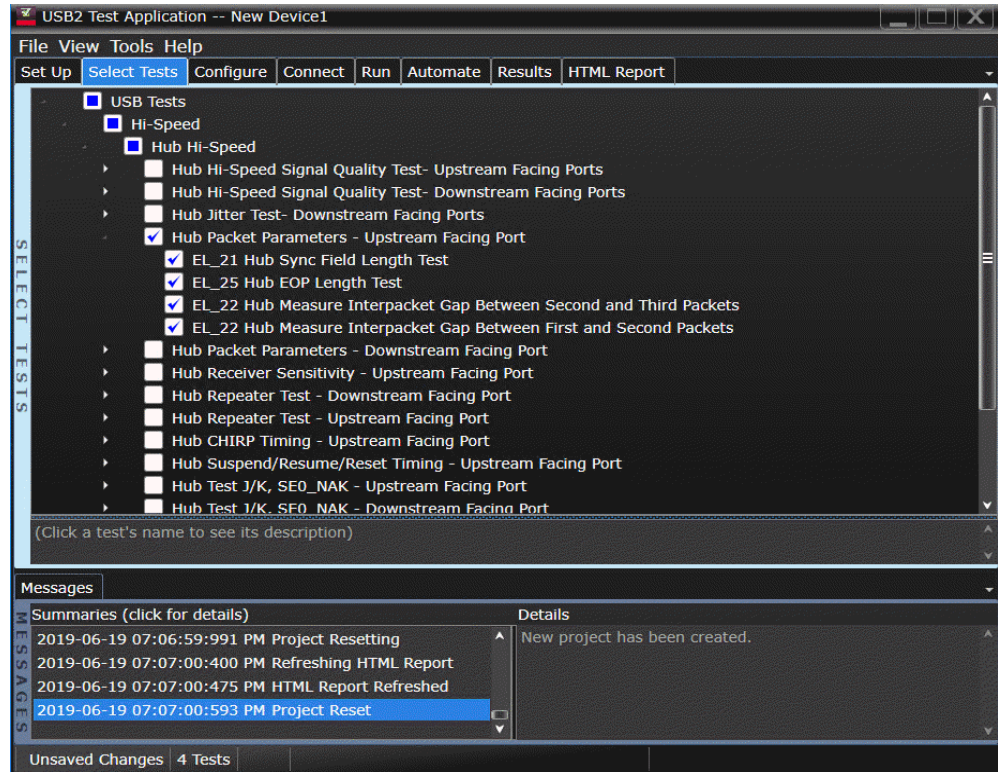

Configuring the Tests

Connecting the Equipment - Differential Connection

The USB automated test application will prompt you to perform these connection steps:

- 1 Connect the Hi-Speed Signal Quality test fixture [INIT PORT] into a high-speed capable port of the test bed, using a USB cable. Do not apply 5V to the test fixture.
- 2 Connect the test fixture [TEST PORT] into B receptacle of the upstream facing port under test of the hub, using the 4" USB cable. Apply power to the hub.
- 3 Attach the differential probe from Channel 1 to D+ and D- of TP2 of the test fixture, using a compatible header adapter.

NOTE

1. If you are using E2649-26401/E2649-26402/E2649-26403/E2649-26404 you would not need to use the damped header adapter.

2. If you are using differential connection test connections for E2649-26401/E2649-26402/E2649-26403, please terminate the SMA connector with 50 Ohm terminators.

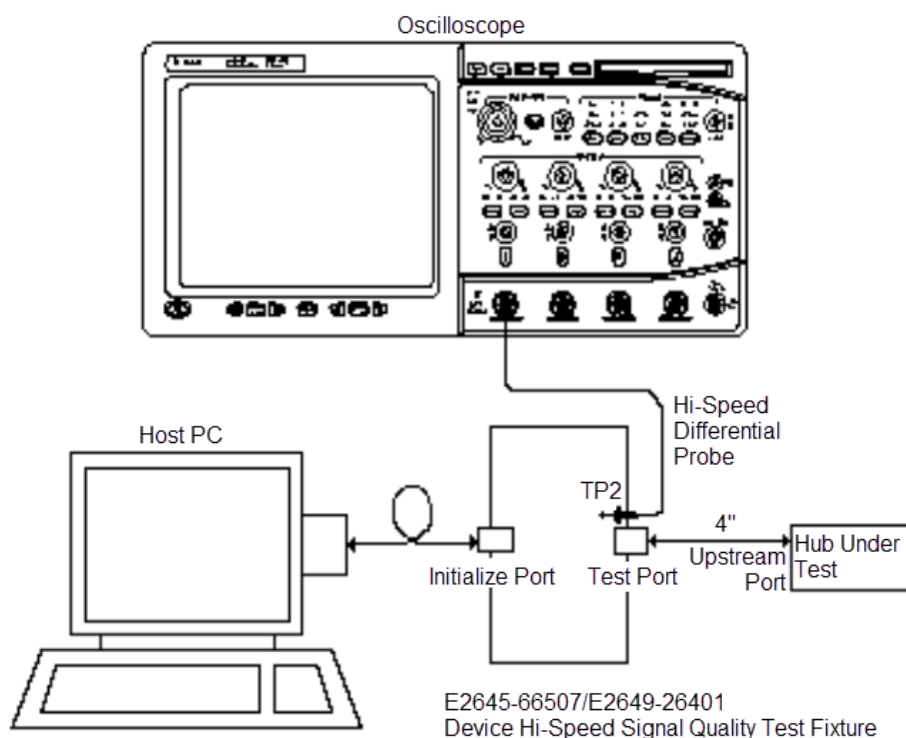

- 4 Check **I have completed these instructions.**

Connecting the Equipment – Single-Ended Connection

The USB automated test application will prompt you to perform these connection steps:

- 1 Connect the Hi-Speed Signal Quality test fixture [INIT PORT] into a high-speed capable port of the test bed, using a USB cable. Do not apply 5V to the test fixture.
- 2 Connect the test fixture [TEST PORT] into B receptacle of the upstream facing port under test of the hub, using the 4" USB cable. Apply power to the hub.
- 3 Attach an active probes on undefined and undefined to D+ and D- on the test fixture respectively.

NOTE

1. If you are using E2649-26401/E2649-26402/E2649-26403/E2649-26404 you would not need to use the damped header adapter.
2. If you are using differential connection test connections for E2649-26401/E2649-26402/E2649-26403, please terminate the SMA connector with 50 Ohm terminators.

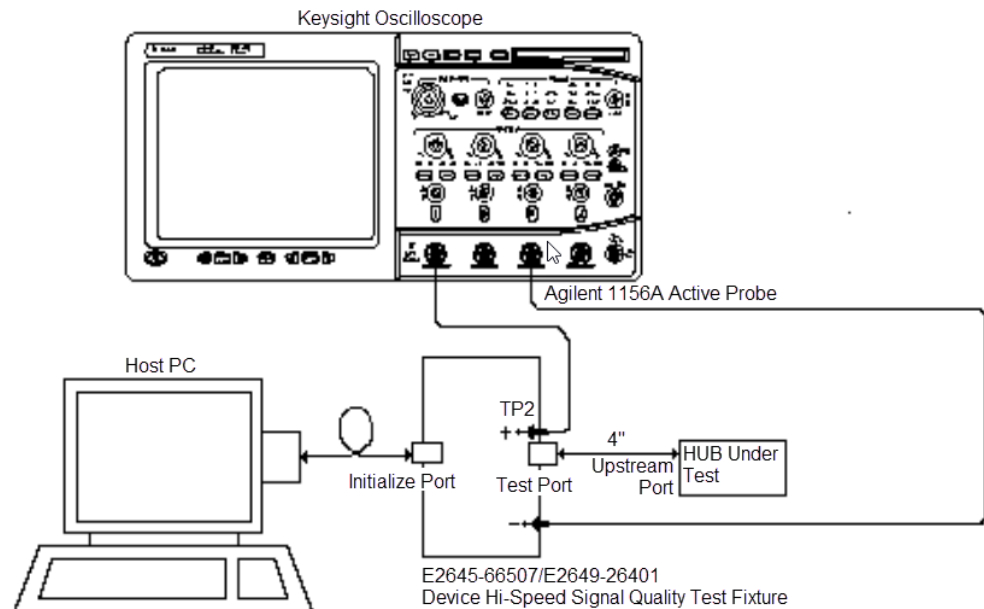

- 4 Check **I have completed these instructions.**

Running the Tests

- 1 Click **Run Tests.**

Test Instructions, Part 1

The USB automated test application will prompt you to perform these steps:

- 1 Exit the Hub Test menu of the HS Electrical Test Tool by clicking the **[Return to Main button]**.
- 2 From the HS Electrical Test Tool main menu select **Device** and click **[TEST]** to enter the Device Test menu.

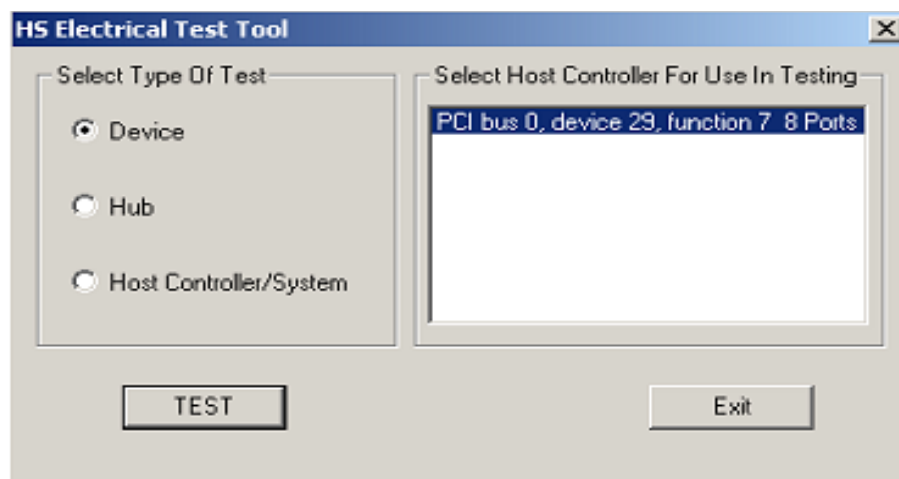

- 3 The Device Test menu of the HS Electrical Test Tool should appear as below.

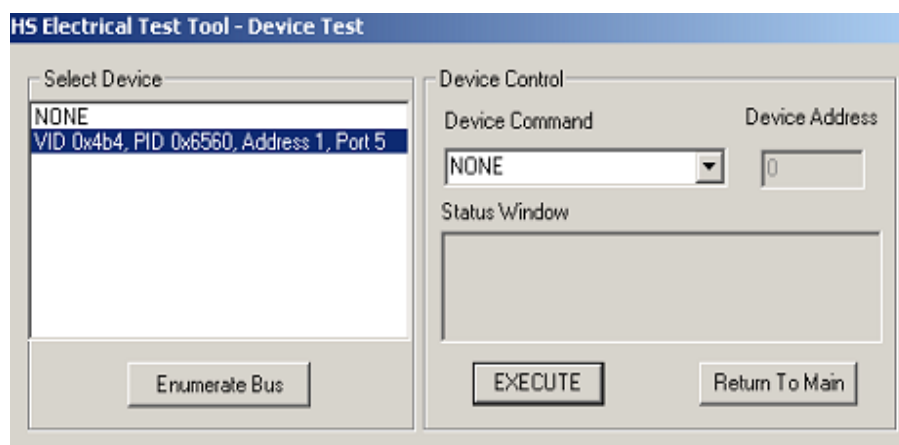

- 4 Using the oscilloscope, verify the SOFs (Start Of Frame) packets are being transmitted on the port under test. You may need to lower the trigger level to somewhat below 400 mV.

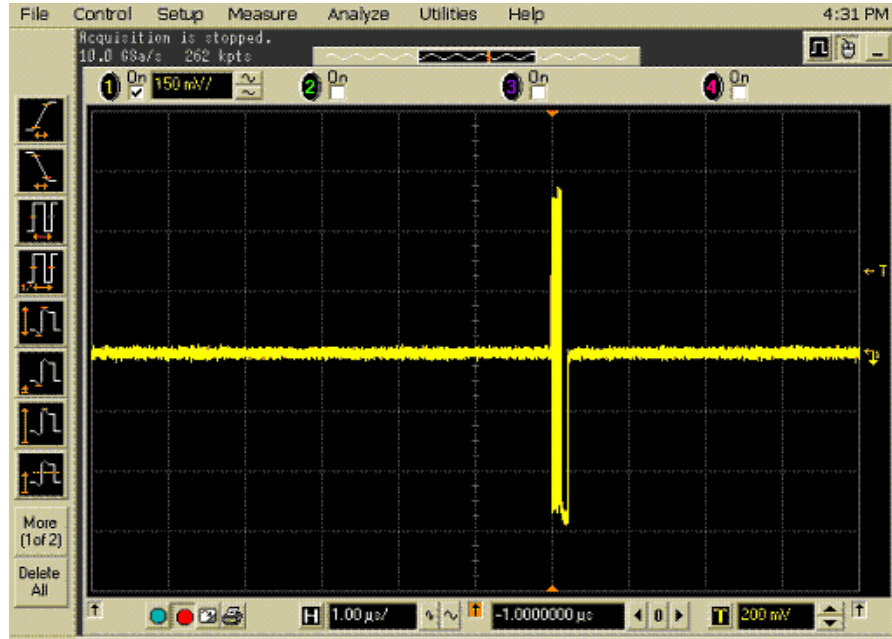

5 Click **OK** to close the Test Instructions dialog.

Test Instructions, Part 2

The USB automated test application will prompt you to perform these steps:

- 1 In the Device Test menu of the HS Electrical Test Tool, ensure that the hub under test is selected.
- 2 Select **SINGLE STEP SET FEATURE** from the Device Command window. Click **[EXECUTE]** once.

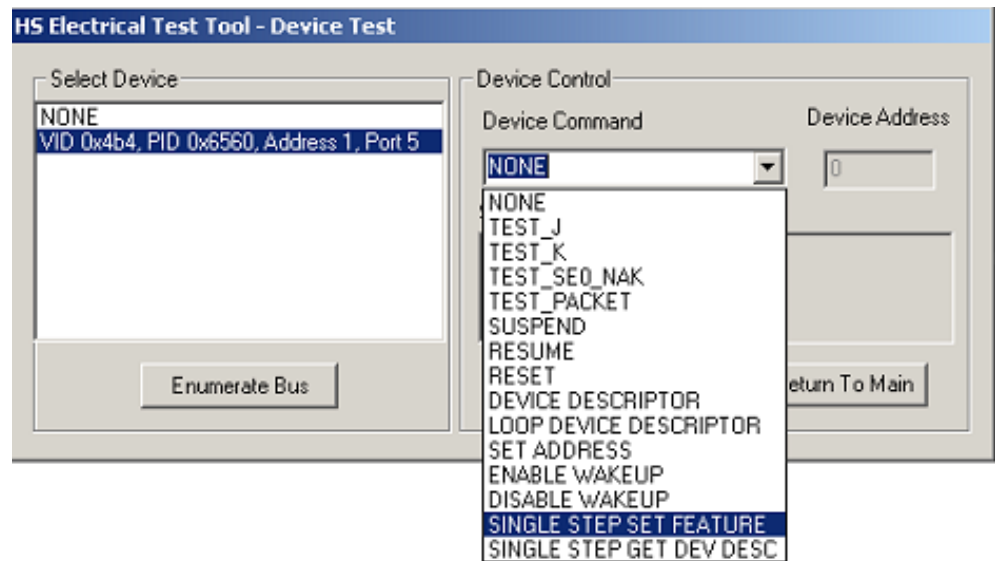

3 You should see the transmitted test packet on the oscilloscope as below.



- 4 Click **OK** to close the Test Instructions dialog.

EL_21 Sync Field Length Test

EL_25 EOP Length Test

EL_22 Measure Interpacket Gap Between Second and Third Packets

EL_22 Measure Interpacket Gap Between First and Second Packets

The USB automated test application will prompt you to perform these steps:

- 1 In the Device Test menu of the HS Electrical Test Tool, click **[STEP]** once again. This is the second step of the two-step Single Step Set Feature command.

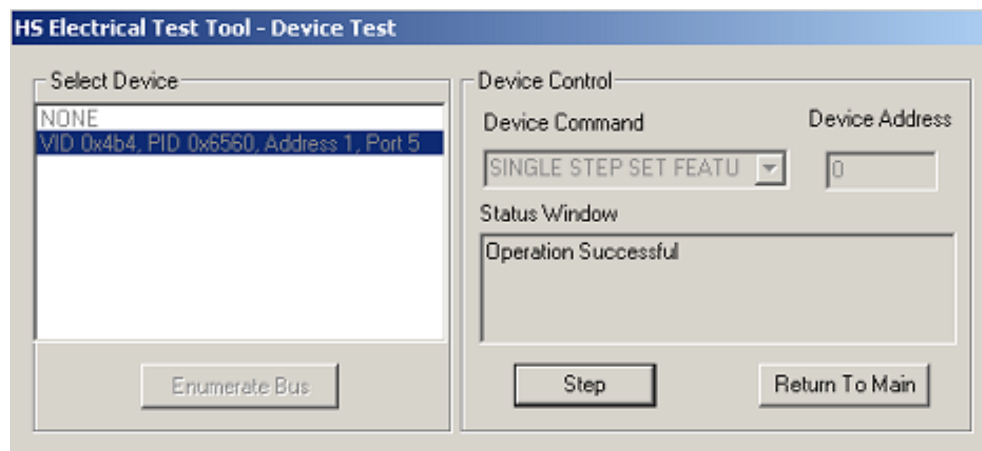

- 2 You should see the transmitted test packet on the oscilloscope as below.

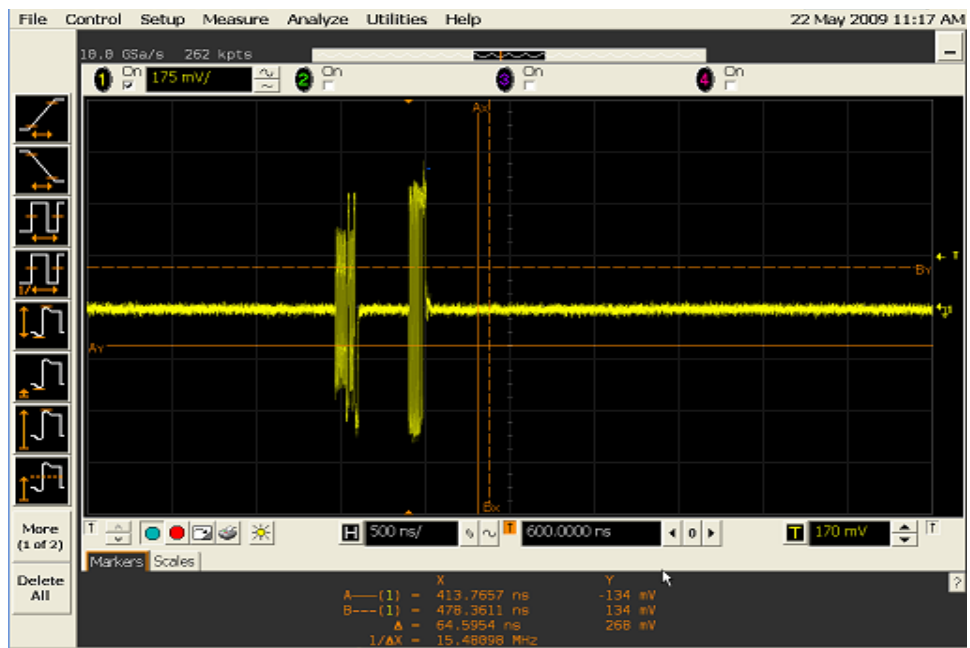

- 3 Click **OK** to close the Test Instructions dialog.

Viewing Test Results

- 1 When the Testing Complete dialog appears, click **OK**.
The Results tab shows the test results.

Hub Packet Parameters - Downstream Facing Port

Equipment Used

Table 20 Equipment Used in Hub Packet Parameters - Downstream Facing Port

Quantity	Item	Description/Model
1	Oscilloscope	Keysight S-Series, 9000A, 90000A, MXR, or UXR Series
1	Probe type	Differential active (at least 2.5 GHz bandwidth) with E2678B socketed probe head
1	Header adapter (only needed if you are using the old test fixture - E2645-66507)	Keysight 01131-68703
1	Host test bed computer	Any computer with hi-speed USB ports
1	Host Hi-Speed Signal Quality test fixture and 4" USB cable	Keysight E2649-66402 (old fixture P/N E2645-66508)
1	5V power supply	Keysight 8121-1966 or equivalent

Selecting the Tests

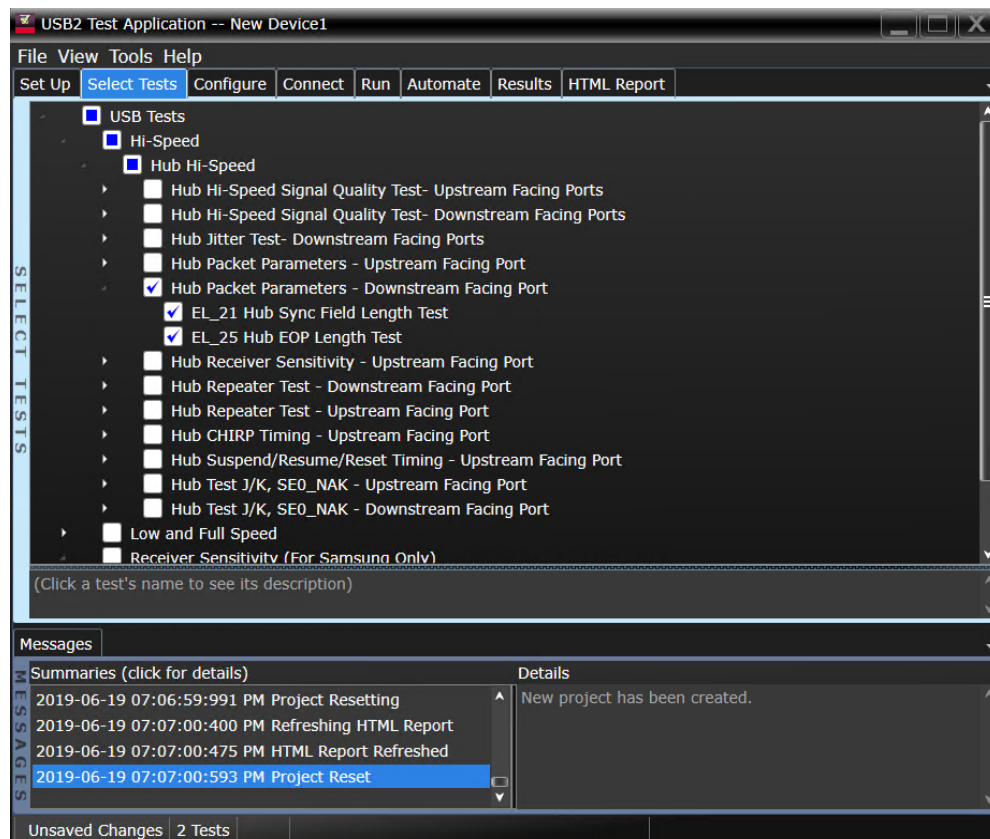

Configuring the Tests

Connecting the Equipment - Differential Connection

The USB automated test application will prompt you to perform these connection steps:

- 1 Connect the Host Hi-Speed Signal Quality test fixture between the downstream port under test of the hub and a known-good hi-speed device.
- 2 Attach a differential probe on Channel 1 to D+ and D- of TP2 of the test fixture, using a compatible header adapter.
- 3 Connect the test fixture's [TEST PORT] to the hub downstream port under test, using the 4" USB cable.
- 4 Connect the test fixture's [INIT PORT] to the known good device.
- 5 Connect the hub upstream port to the host controller.
- 6 Apply power to the hub and the known good device.

NOTE

1. If you are using E2649-26401/E2649-26402/E2649-26403/E2649-26404 you would not need to use the damped header adapter.
2. If you are using differential connection test connections for E2649-26401/E2649-26402/E2649-26403, please terminate the SMA connector with 50 Ohm terminators.

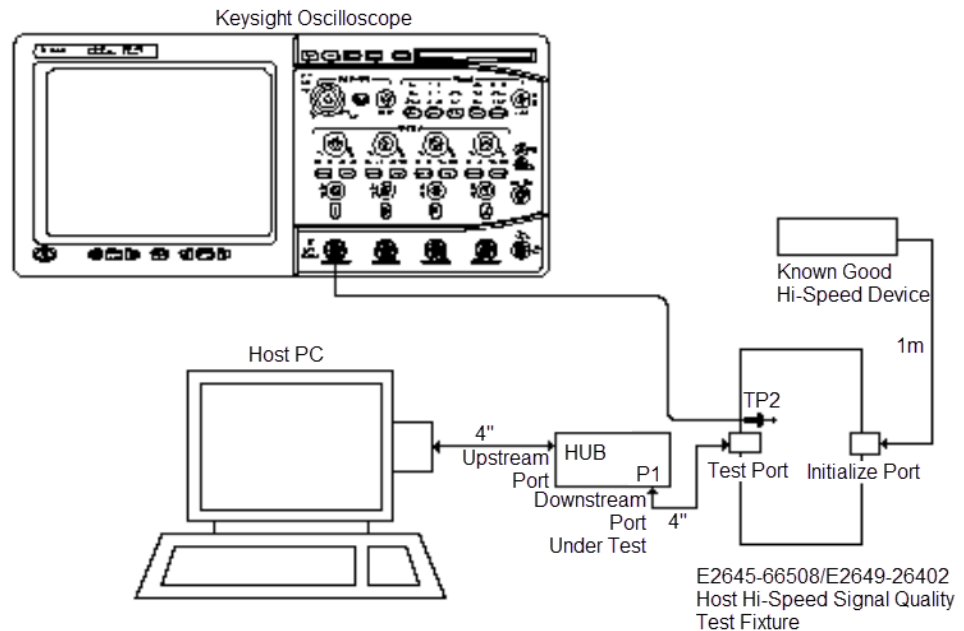

Connecting the Equipment - Single-Ended Connection

The USB automated test application will prompt you to perform these connection steps:

- 1 Connect the Hi-Speed Signal Quality test fixture between the downstream port under test of the hub and a known-good hi-speed device.
- 2 Attach active probes on undefined and undefined to D+ and D- on the test fixture respectively.

- 3 Connect the test fixture's [TEST PORT] to the hub downstream port under test, using the 4" USB cable.
- 4 Connect the test fixture's [INIT PORT] to the known good device.
- 5 Connect the hub upstream port to the host controller.
- 6 Apply power to the hub and the known good device.

NOTE

1. If you are using E2649-26401/E2649-26402/E2649-26403/E2649-26404 you would not need to use the damped header adapter.

2. If you are using differential connection test connections for E2649-26401/E2649-26402/E2649-26403, please terminate the SMA connector with 50 Ohm terminators.

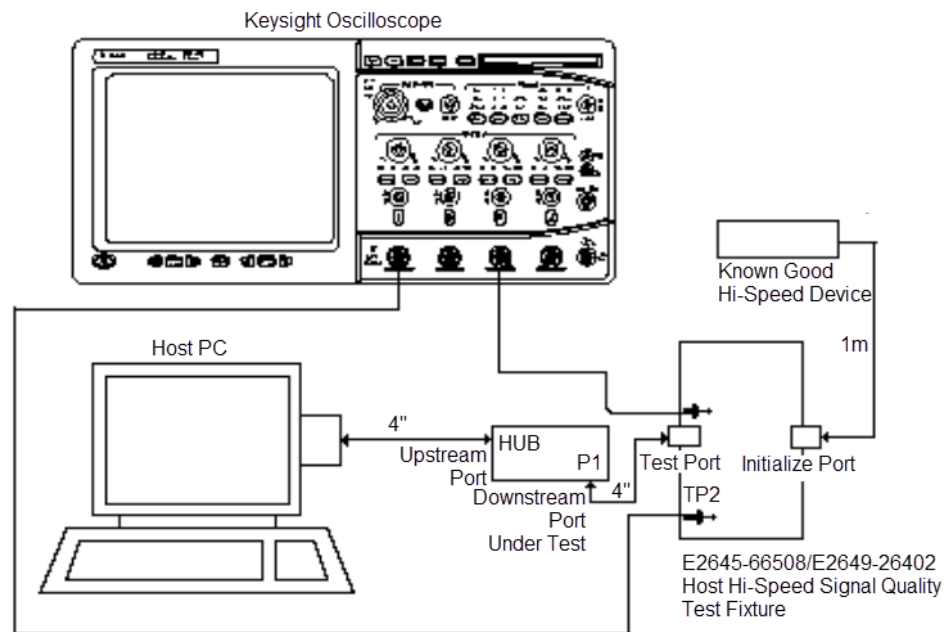

Running the Tests

- 1 Click **Run Tests**.

Test Instructions, Part 1

The USB automated test application will prompt you to perform these steps:

- 1 Exit the Hub Test menu of the HS Electrical Test Tool by clicking the **[Return to Main]** button.
- 2 From the HS Electrical Test Tool main menu select Host and click **[TEST]** to enter the Host Test menu.

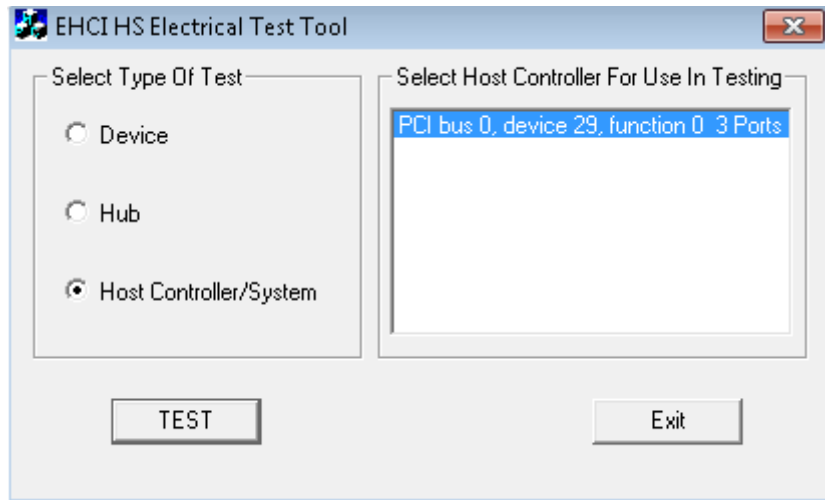

- 3 The Host Test menu of the HS Electrical Test Tool should appear as below.

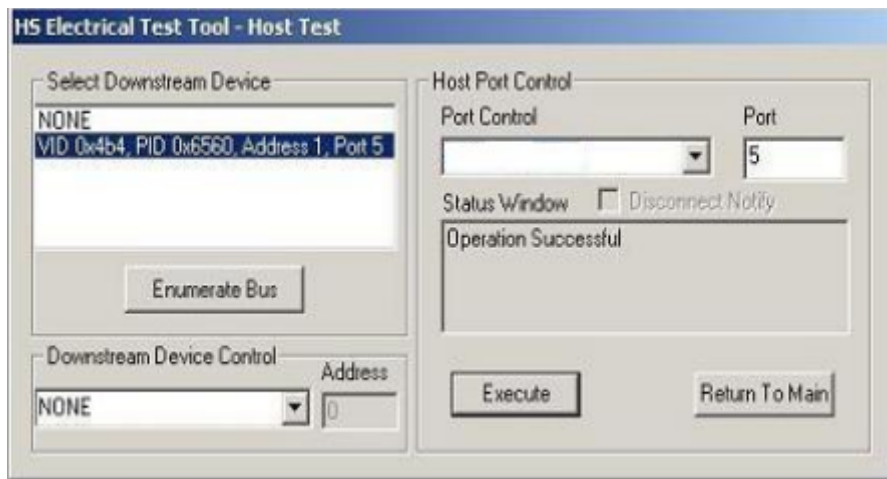

- 4 Using the oscilloscope, verify the SOFs (Start Of Frame) packets are being transmitted on the port under test. You may need to lower the trigger level to somewhat below 400 mV.

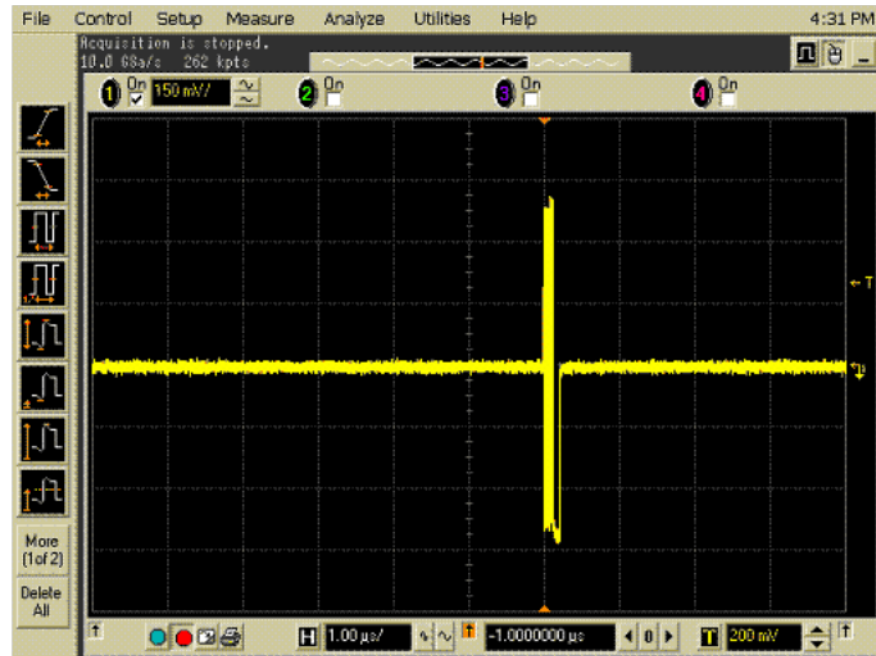

- 5 Click **OK** to close the Test Instructions dialog.

Test Instructions, Part 2

The USB automated test application will prompt you to perform these steps:

- 1 In the Host Test menu of the HS Electrical Test Tool, ensure that the hub under test is selected.
- 2 Select **SINGLE STEP GET DEV DESC** from the Downstream Device Control Command window. Click **[EXECUTE]**.

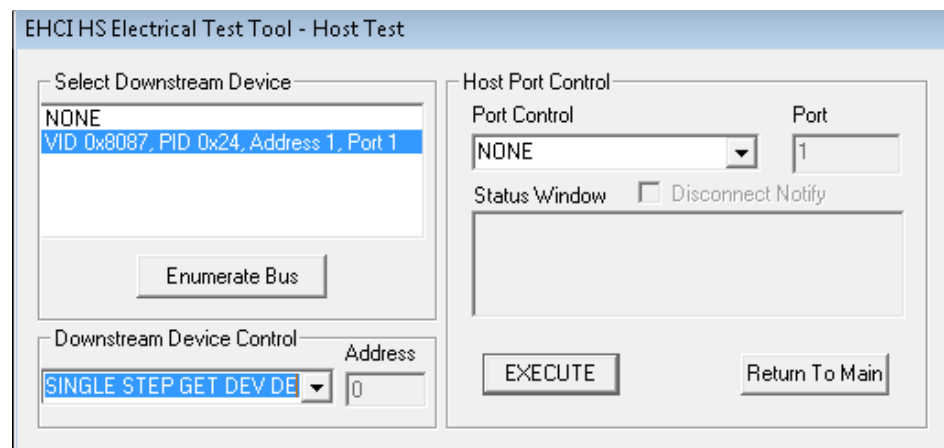

- 3 You should see the transmitted test packet on the oscilloscope as below.



4 Click **OK** to close the Test Instructions dialog.

EL_21 Sync Field Length Test EL_25 EOP Length Test

EL_25 EOP Length Test

Hub Receiver Sensitivity - Upstream Facing Port

Equipment Used

Table 21 Equipment Used in Hub Receiver Sensitivity - Upstream Facing Port

Quantity	Item	Description/Model
1	Oscilloscope	Keysight S-Series, 9000A, 90000A, MXR, or UXR Series
1	Probe type	Differential active (at least 2.5 GHz bandwidth) with E2678B socketed probe head
1	Header adapter (only needed if you are using the old test fixture - E2645-66503)	Keysight 01131-68703
1	Host test bed computer	Any computer with hi-speed USB ports
1	Receiver Sensitivity test fixture and 4" USB cable	Keysight E2649-66403 (old fixture P/N E2645-66503)
1	5V power supply	Keysight 8121-1966 or equivalent
1	Digital signal generator	Keysight 81160A / 81160A (or 81134A with two 15433B transition time converters connected to the pulse generator outputs)
1	USB/GPIB interface	Keysight 82357B
2	6 dB attenuators	Keysight 8493C
2	50 ohm coaxial cable with male SMA connectors at both ends	Keysight 8120-4948 or equivalent
1	5 meter USB 2.0 hi-speed cable	Any listed on USB-IF web site

Selecting the Tests

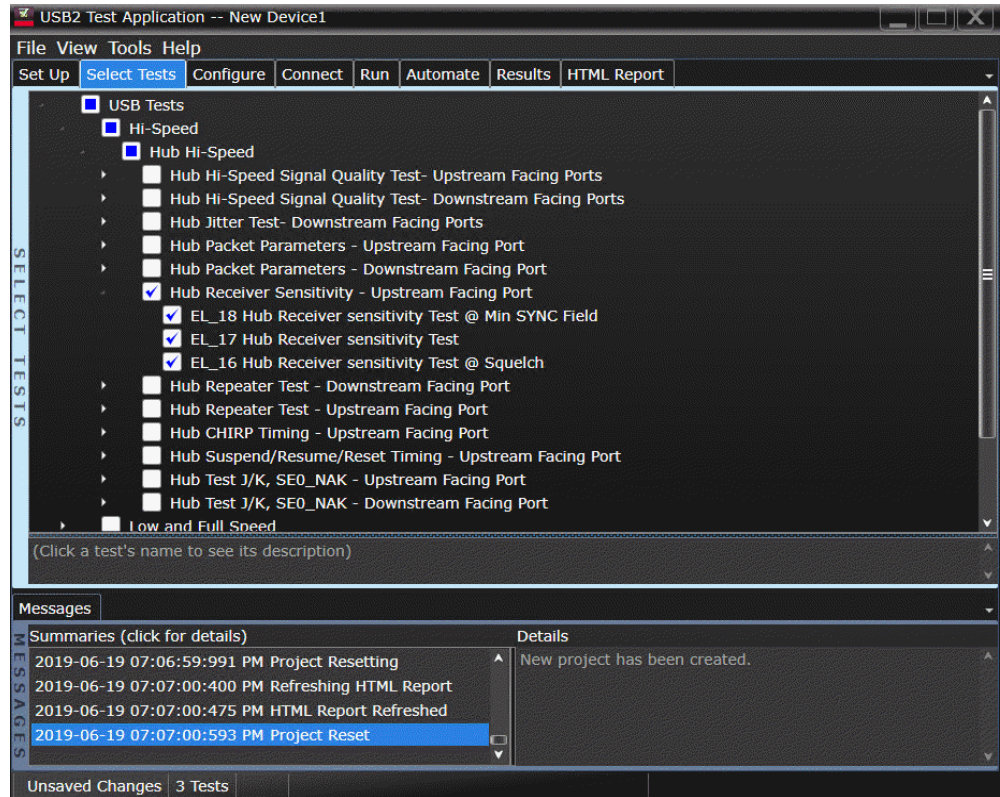

Configuring the Tests

If the pulse generator's SICL address is different from the default, make sure you set the 81134A/81160A Instrument Address configuration option to the pulse generator's SICL address.

Configuring the 81134A pulse generator using the 82357B GPIB-USB converter

- 1 Ensure that IO Controls is already running by checking the task bar at the bottom right of the screen.

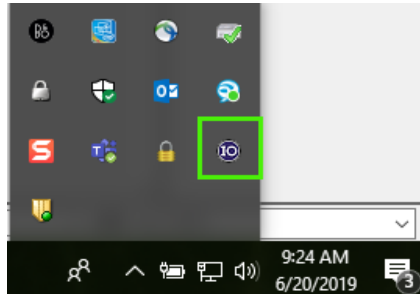

- 2 Open Keysight Connection Expert.

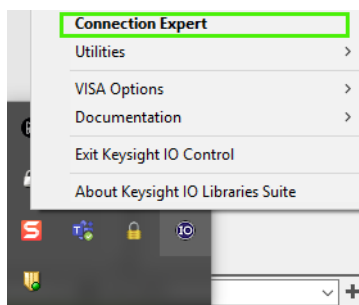

- 3 If the IO Control has not been launched, go to **Start > All Programs > Keysight Connection Expert**.

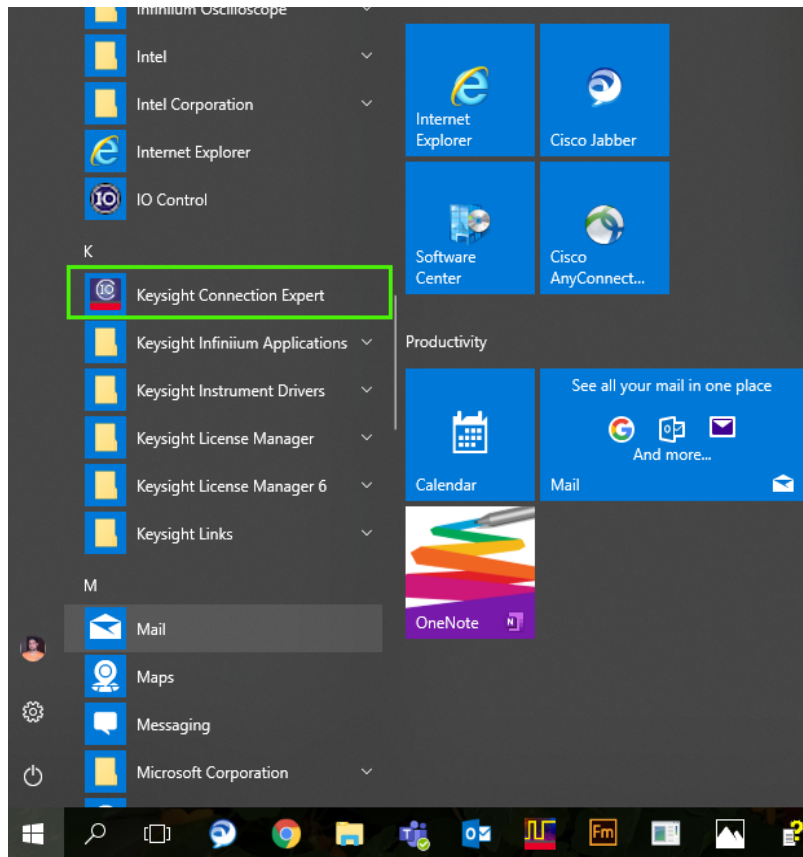

- Click the button “**Refresh All**”, check under USB/GPIB connection and click on the detected instrument.

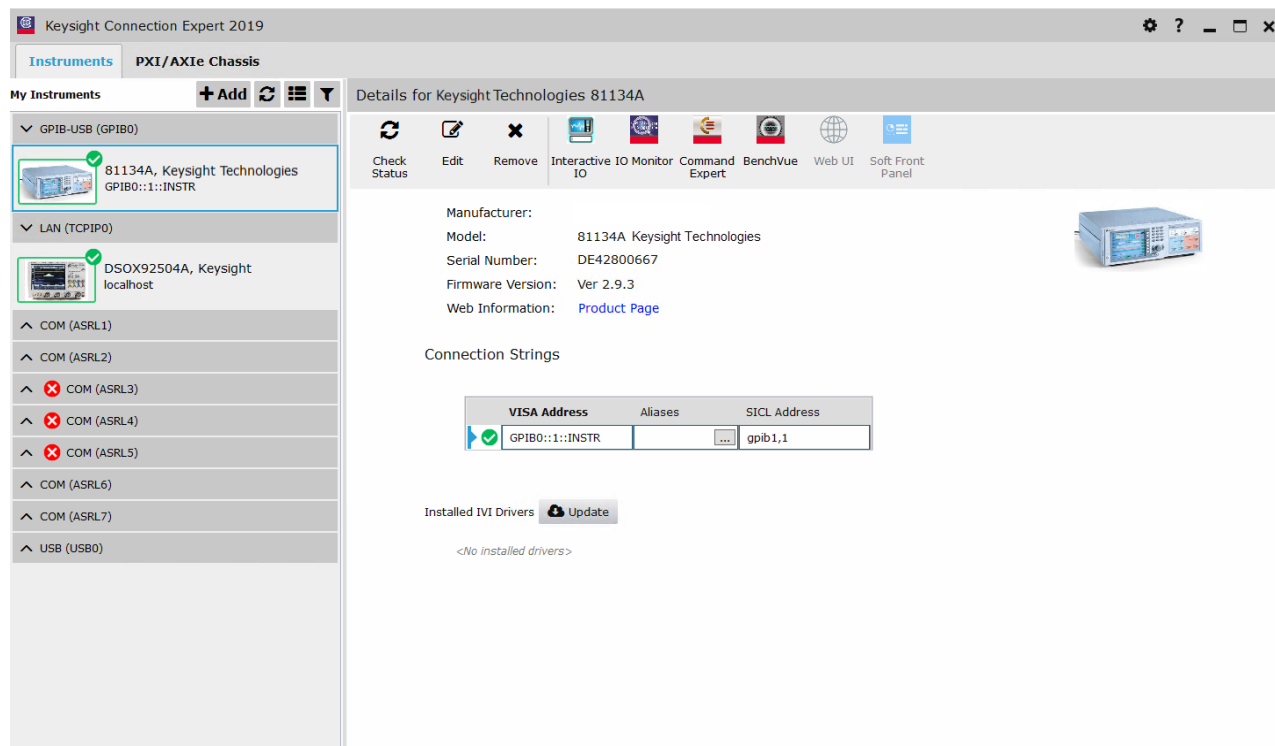

- Copy the SICL address for example **gpib0,13**.
- In the USB application, select “**Yes**” if using **81160A/81134A**. Then click on **Configure Devices** button.

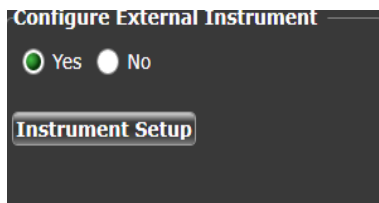

- Select the for **SICL address** option, then paste the SICL address in the text box.

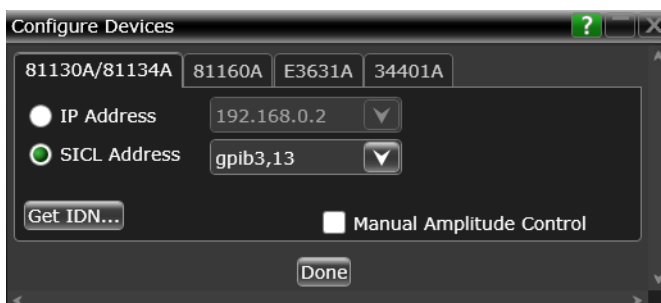

- Press the “**Get IDN**” button to verify the connection status. You should see the message box below if successfully connected.

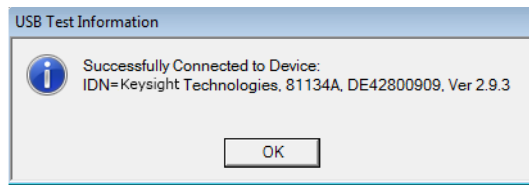

9 Finally click the **"DONE"** button to save the connection setting.

Connecting the Equipment

The USB automated test application will prompt you to perform these connection steps:

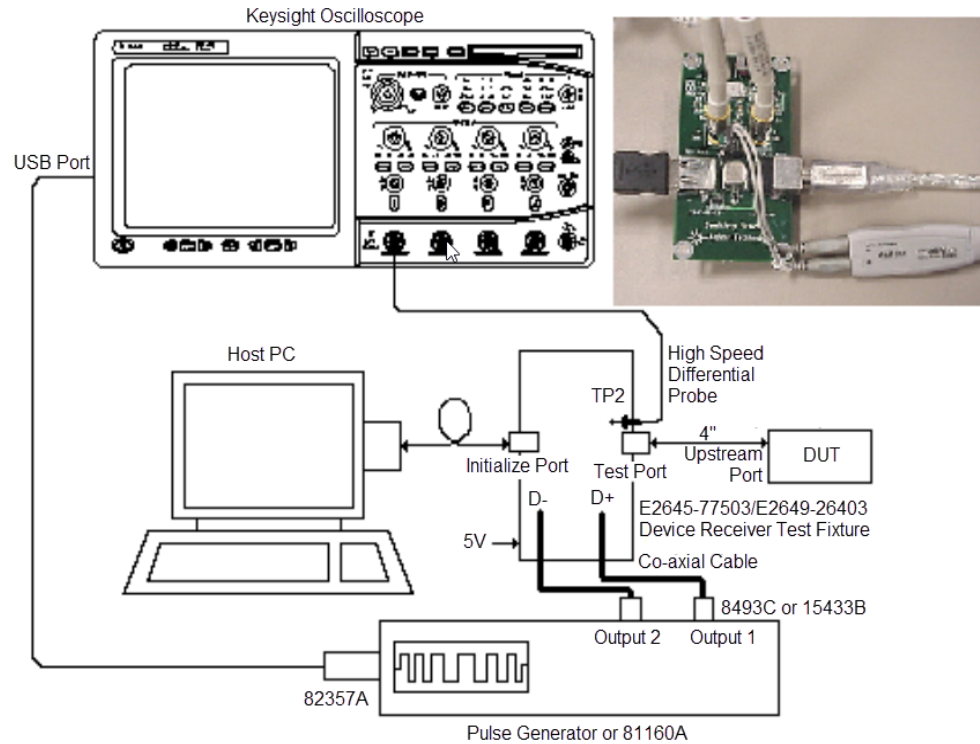

- 1 Attach the 5V power supply to the E2649-66403 (E2645-66503 if you are using the old fixture) Device Receiver test fixture (J5).
 - a Verify the green Power LED is lit.
 - b Leave the TEST switch at the OFF position.
 - c The yellow LED (D2) should be off.
- 2 Connect the [INIT PORT] of the fixture to a Hi-Speed port on the Test Bed Computer, using USB cable.
- 3 Connect the [TEST PORT] of the fixture to the device under test, using the 4" USB cable.
- 4 Connect high speed differential probe on Channel 1 to D+ and D- of the test fixture at TP2.

NOTE

For the E2645-66503 fixture, ensure the + polarity on the probe lines up with D+, which is the pin nearest the USB connector.

- 5 Connect the 81130A / 81134A / 81160A to the oscilloscope using the 82357A USB/GPIB Interface.
 - a If you choose to use the Keysight 81130A Pulse/Pattern Generator, connect the 8493C 6dB attenuators to OUTPUT1 and OUTPUT2 of Keysight 81130A Pulse/Pattern Generator.
 - b If you choose to use the Keysight 81134A Pulse/Pattern Generator, connect the 15433B Transition Time Converters to OUTPUT1 and OUTPUT2 of Keysight 81134A Pulse/Pattern Generator. Keysight 15433B Transition Time Converters are recommended, to reduce the output edge speed of the 81134A to speed close to what the 81130A provides.

- 6 Connect OUTPUT1 to SMA1 (D+) of the E2649-26403 Device Receiver Sensitivity test fixture using the 8120-4948 SMA cables.
- 7 Connect OUTPUT2 to SMA2 (D-) of the E2649-26403 Device Receiver Sensitivity test fixture using the 8120-4948 SMA cables.

NOTE

If you are using E2649-26401/E2649-26402/E2649-26403/E2649-26404 you would not need to use the damped header adapter.

- 8 Check **I have completed these instructions.**

Running the Tests

- 1 Click **Run Tests**.

Test Instructions

The USB automated test application will prompt you to perform these steps:

- 1 Exit the HS Electrical Test Tool - Device Test menu by clicking the **[Return to Main]** button. From the HS Electrical Test Tool main menu select **Hub** and click **[TEST]** to enter the Hub Test menu.
- 2 On the Hub Test Menu, click **[Enumerate Bus]** button once and verify that the hub enumerates properly.
- 3 Select **TEST_SEO_NAK** from the Hub Command drop down menu. Click **[EXECUTE]** once to place the hub into TEST_SEO_NAK test mode.

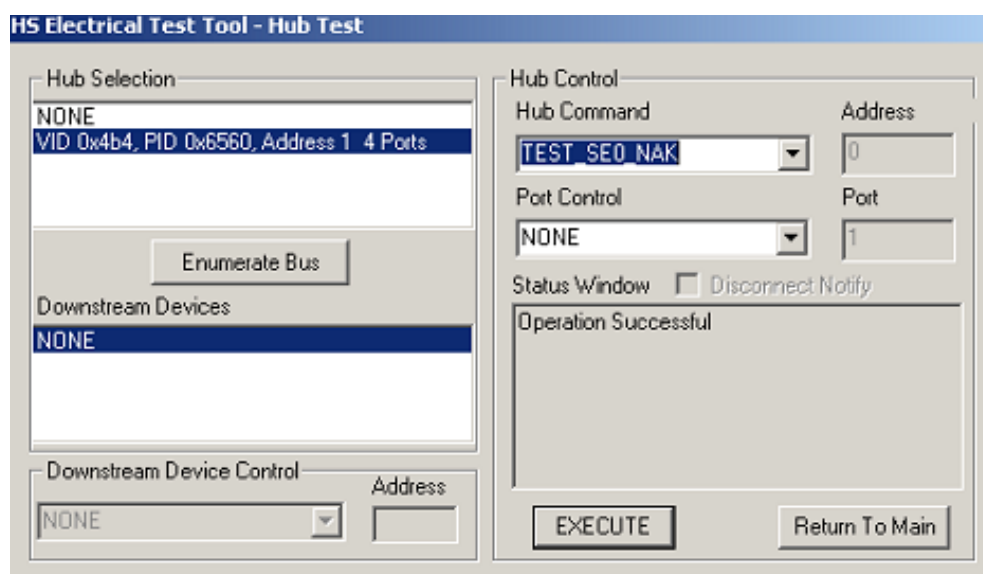

- 4 Place the test fixture Test Switch (S1) into the **TEST** position. This switches in the data generator in place of the host controller. The data generator emulates the "IN" packets from the host controller.

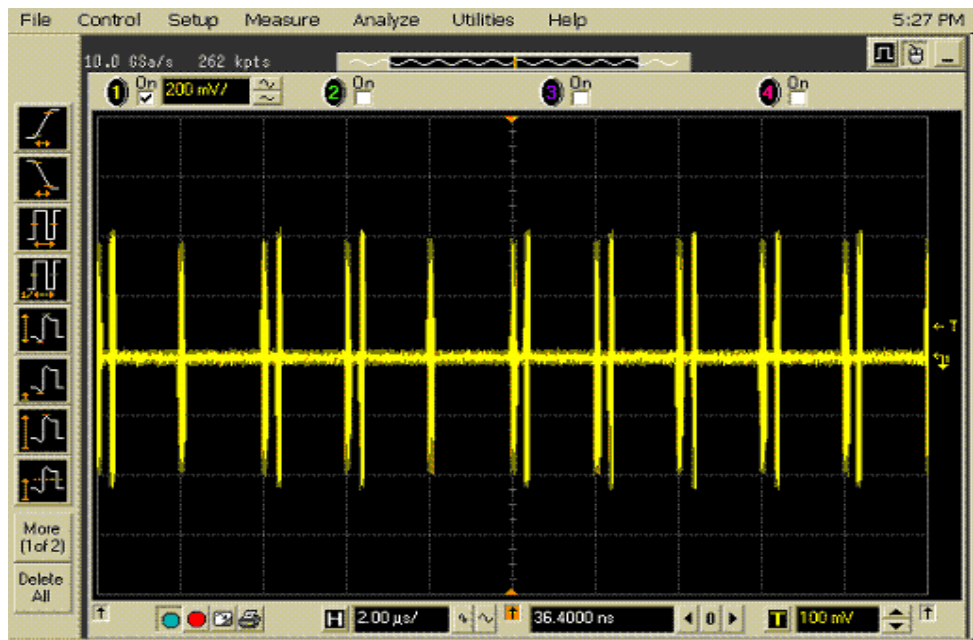

- 5 Click **OK** to close the Test Instructions dialog.

EL_18 Receiver sensitivity Test @ Min SYNC Field

EL_17 Receiver sensitivity Test

EL_16 Receiver sensitivity Test @ Squelch

Viewing Test Results

- 1 When the Testing Complete dialog appears, click **OK**.
The Results tab shows the test results.

Hub Repeater Test - Downstream Facing Port

Equipment Used

Table 22 Equipment Used in Hub Repeater Test - Downstream Facing Port

Quantity	Item	Description/Model
1	Oscilloscope	Keysight S-Series, 9000A, 90000A, MXR, or UXR Series
2	Probe type	Differential active (at least 2.5 GHz bandwidth) with E2678B socketed probe head
2	Header adapter (only needed if you are using the old test fixtures - E2645-66507 or E2645-66508)	Keysight 01131-68703
1	Host test bed computer	Any computer with hi-speed USB ports
1	Device Hi-Speed Signal Quality test fixture and 4" USB cable	Keysight E2666B
1	Host Hi-Speed Signal Quality test fixture and 4" USB cable	Keysight E2649-66402 (old fixture P/N E2645-66508)
2	5 meter USB 2.0 hi-speed cable	Any listed on USB-IF web site
2	1 meter USB cable	Any listed on USB-IF web site

Selecting the Tests

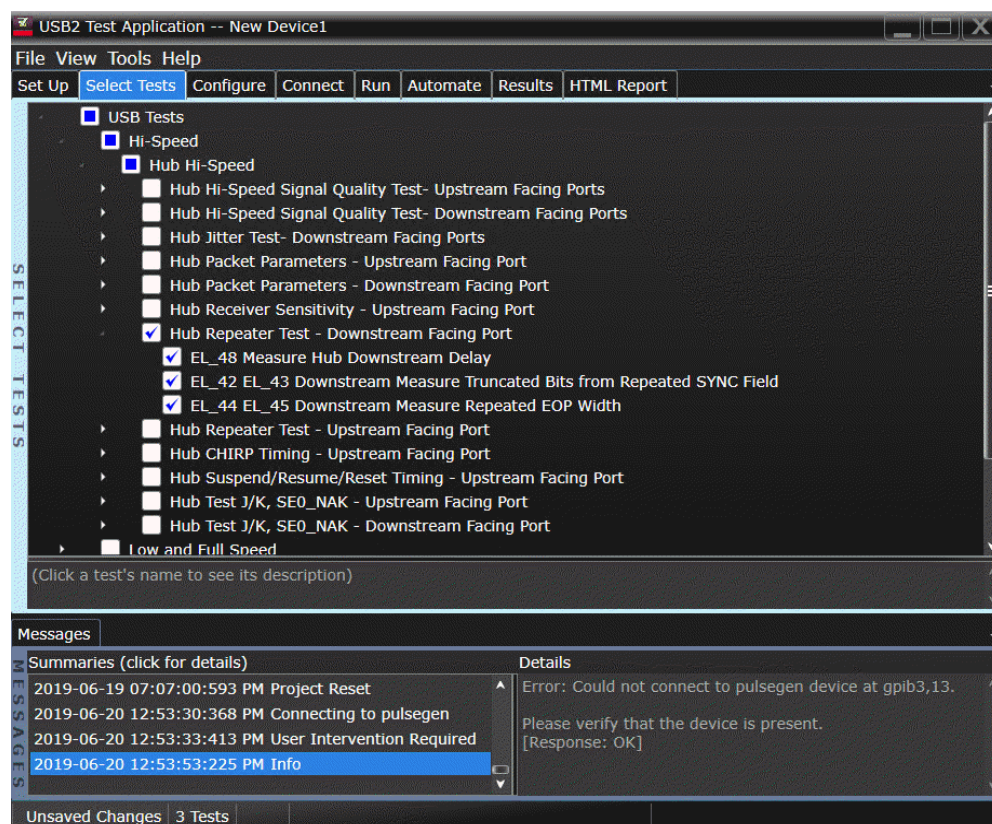

Configuring the Tests

Connecting the Equipment

The USB automated test application will prompt you to perform these connection steps:

- 1 Connect the E2649-26401 (E2645-66507 if you are using the old fixture) Device Hi-Speed Signal Quality test fixture between the upstream facing port of the hub and the host controller port.
 - a Attach the Channel 1 differential probe to D+ and D- of TP2 of the fixture. Ensure the + polarity on the probe lines up with D+ on the fixture.
 - b Connect the fixture's [TEST PORT] to the hub's upstream port with the 4" USB cable.
 - c Connect the fixture's [INIT PORT] to the controller port with the 5 meter USB cable.
- 2 Connect the E2649-26402 (E2645-66508 if you are using the old fixture) Host Hi-Speed Signal Quality test fixture between the downstream port under test of the hub and a known-good hi-speed device.
 - a Attach the Channel 4 differential probe to TP2 of the fixture. Ensure the + polarity on the probe lines up with the D+ on the fixture. The D+ pin is the pin closest to the USB connector.
 - b Connect the test fixture's [TEST PORT] to the hub downstream port under test, using the 4" USB cable.
 - c Connect the test fixture's [INIT PORT] to the known good device using the 1 meter USB cable.
 - d Apply power to the hub and the known good device.

NOTE

1. If you are using E2649-26401/E2649-26402/E2649-26403/E2649-26404 you would not need to use the damped header adapter.
2. If you are using differential connection test connections for E2649-26401/E2649-26402/E2649-26403, please terminate the SMA connector with 50 Ohm terminators.

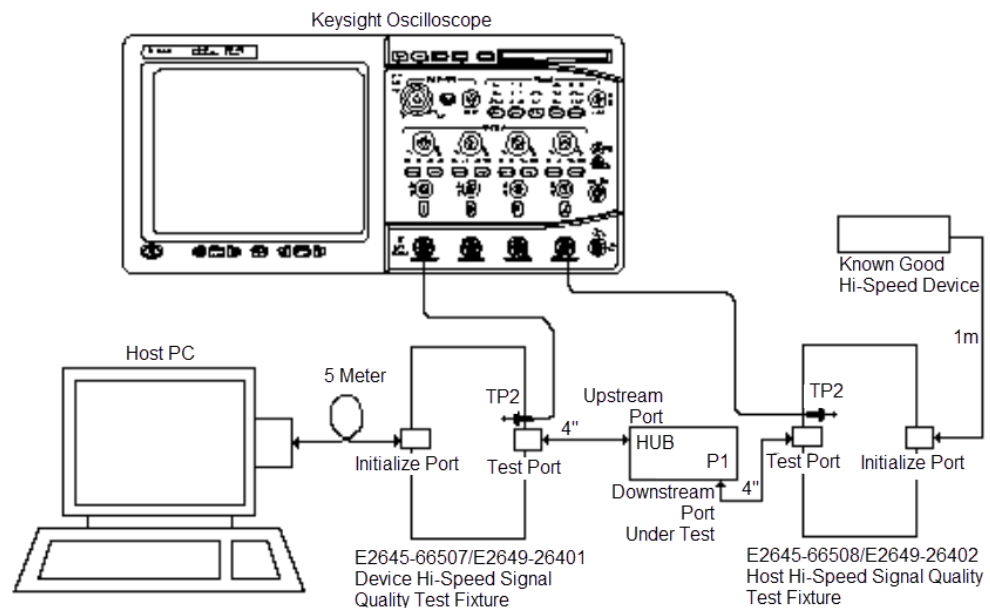

- 3 Check **I have completed these instructions.**

Running the Tests

- 1 Click **Run Tests**.

Test Instructions

The USB automated test application will prompt you to perform these steps:

- 1 On the Hub Test menu of the HS Electrical Test Tool, click **[Enumerate Bus]** once.
 - a The hub under test should be enumerated with the hub's VID shown together with the USB address.
 - b Likewise the known good device should be enumerated with its VID shown together with the hub port in which it is connected.

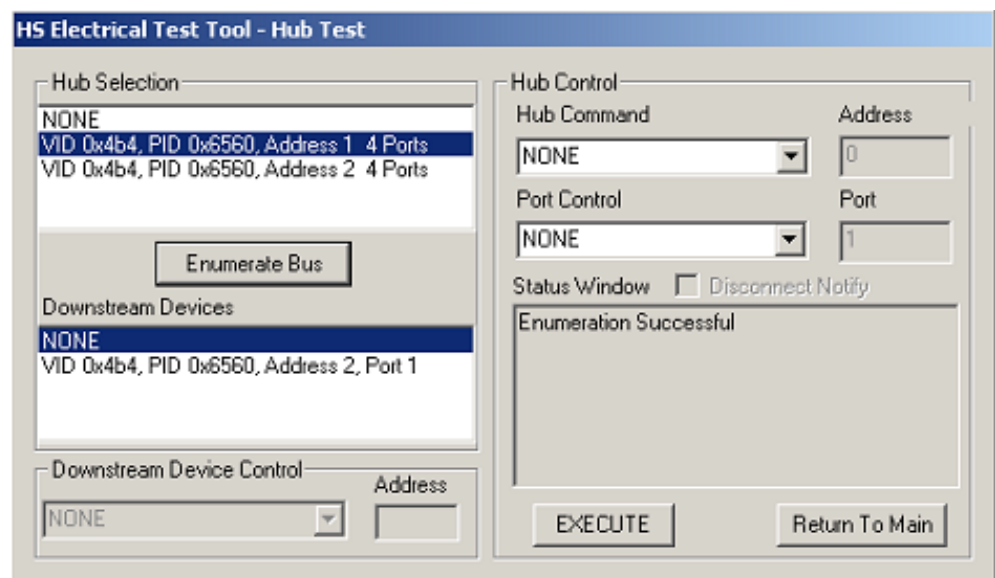

- 2 The captured transition should be as in the figure below.

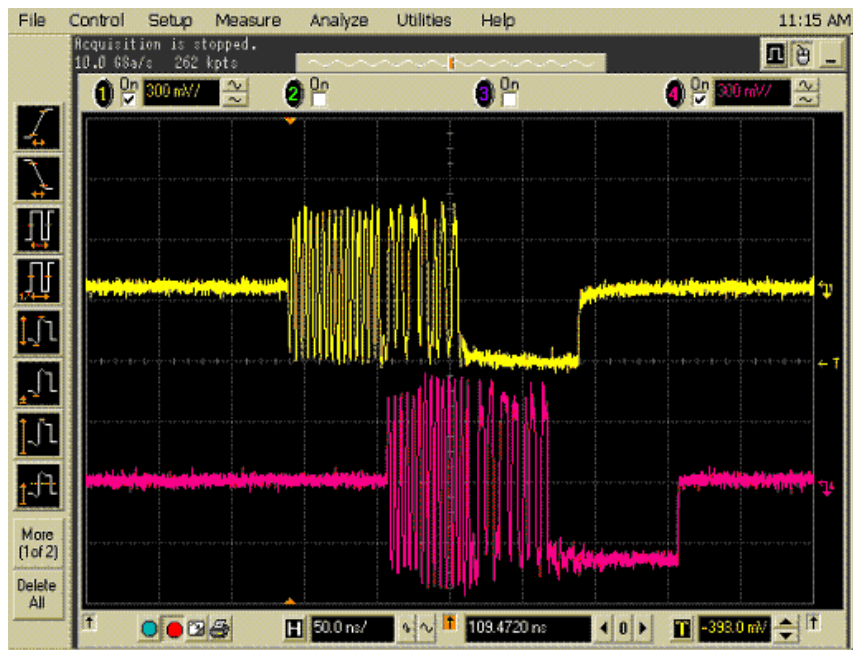

3 Check **I have completed these instructions.**

EL_48 Measure Hub Downstream Delay

EL_42 EL_43 Measure Truncated Bits from Repeated SYNC Field

EL_44 EL_45 Measure Repeated EOP Width

Viewing Test Results

- 1 When the Testing Complete dialog appears, click **OK**.
The Results tab shows the test results.

Hub Repeater Test - Upstream Facing Port

Equipment Used

Table 23 Equipment Used in Hub Repeater Test - Upstream Facing Port

Quantity	Item	Description/Model
1	Oscilloscope	Keysight S-Series, 9000A, 90000A, MXR, or UXR Series
2	Probe type	Differential active (at least 2.5 GHz bandwidth) with E2678B socketed probe head
2	Header adapter (only needed if you are using the old test fixtures - E2645-66507 or E2645-66508)	Keysight 01131-68703
1	Host test bed computer	Any computer with hi-speed USB ports
1	Device Hi-Speed Signal Quality test fixture and 4" USB cable	Keysight E2666B
1	Host Hi-Speed Signal Quality test fixture and 4" USB cable	Keysight E2649-66402 (old fixture P/N E2645-66508)
2	5 meter USB 2.0 hi-speed cable	Any listed on USB-IF web site
2	1 meter USB cable	Any listed on USB-IF web site

Selecting the Tests

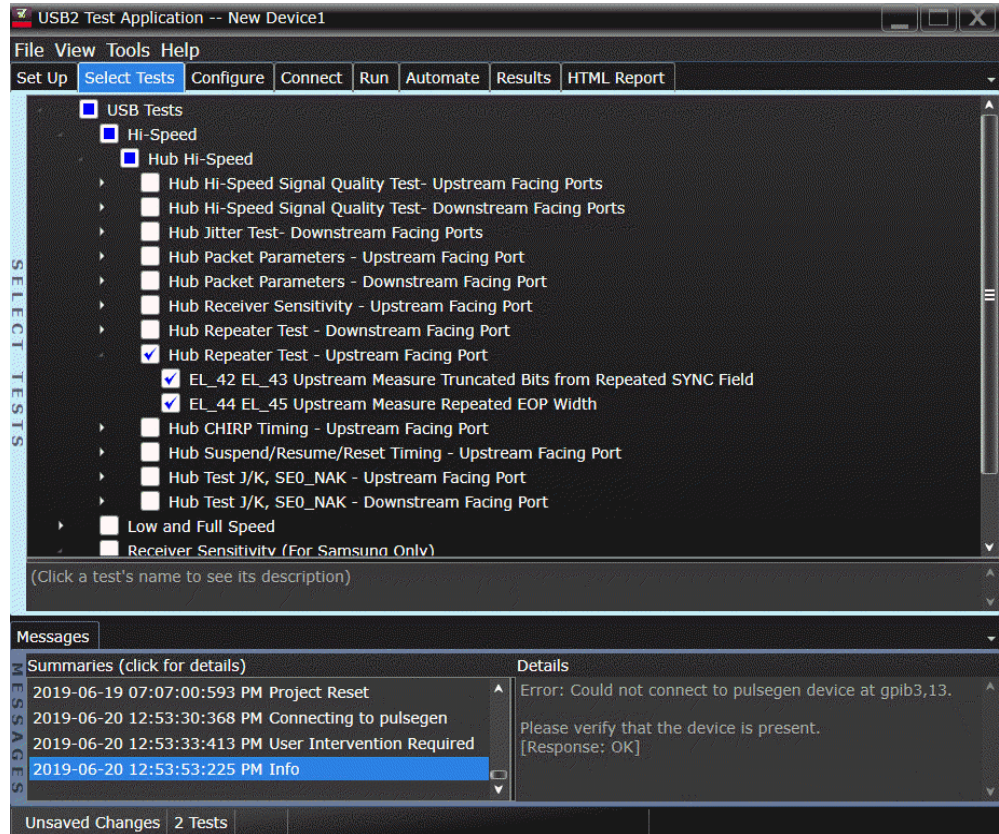

Configuring the Tests

Connecting the Equipment

The USB automated test application will prompt you to perform these connection steps:

- 1 Connect the E2649-26402 (E2645-66508 if you are using the old fixture) Host Hi-Speed Signal Quality test fixture between the upstream facing port of the hub and the host controller port.
 - a Attach the Channel 1 differential probe to TP2 of the fixture. Ensure the + polarity on the probe lines up with D+ on the fixture. The D+ pin is the pin closest to the USB connector.
 - b Connect the fixture's [INIT PORT] to the hub's upstream port, with the 5 meter USB cable.
 - c Connect the fixture's [TEST PORT] to the host controller port, using the 4" USB cable.
- 2 Connect the E2649-26401 (E2645-66507 if you are using the old fixture) Device Hi-Speed Signal Quality test fixture between the downstream port under test of the hub and a known good hi-speed device, nearest to the device.
 - a Attach the Channel 4 differential probe to D+ and D- of TP2 of the fixture. Ensure the + polarity on the probe lines up with the D+ on the fixture.
 - b Connect the test fixture's [TEST PORT] to a known good device using the 4" USB cable.
 - c Connect the test fixture's [INIT PORT] to the hub's downstream port under test using the 1 meter USB cable.
 - d Apply power to the hub and the known good device.

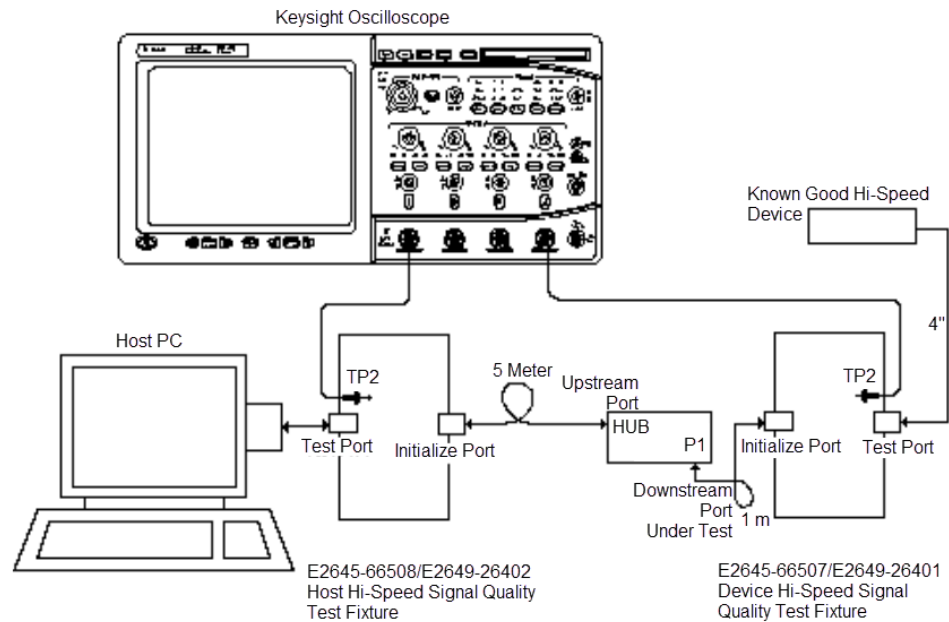

3 Check **I have completed these instructions.**

Running the Tests

- 1 Click **Run Tests**.

Test Instructions, Part 1

The USB automated test application will prompt you to perform these steps:

- 1 On the Hub Test menu of the HS Electrical Test Tool, click **[Enumerate Bus]** once.
 - a The hub under test should be enumerated with the hub's VID shown together with the USB address.
 - b Likewise the known good device should be enumerated with its VID shown together with the hub port in which it is connected.

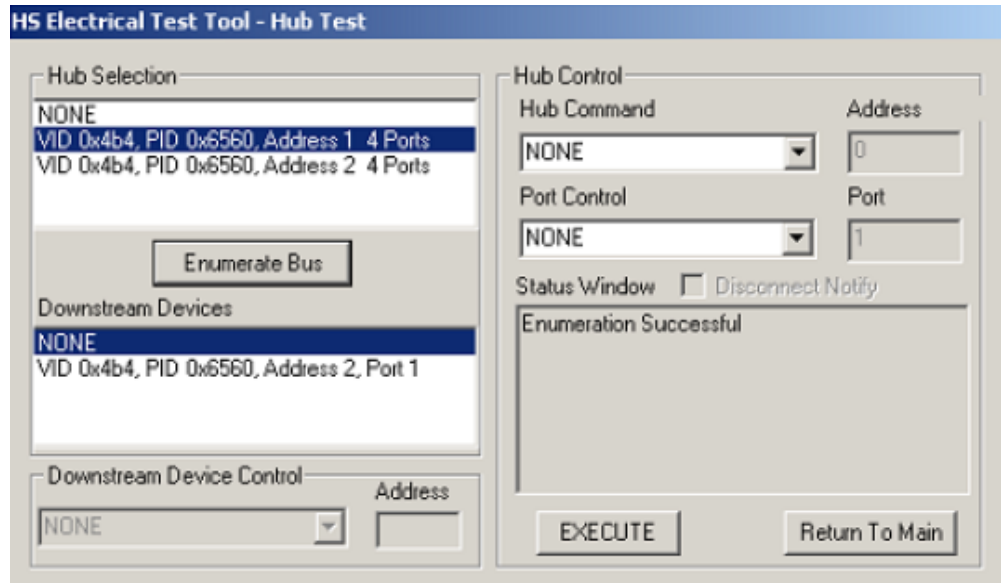

- 2 Check **I have completed these instructions.**

Test Instructions, Part 2

- 1 On the Hub Test menu of the HS Electrical Test Tool, select **SINGLE STEP SET FEATURE** from the Downstream Device Control drop down menu and click **[EXECUTE]** once.

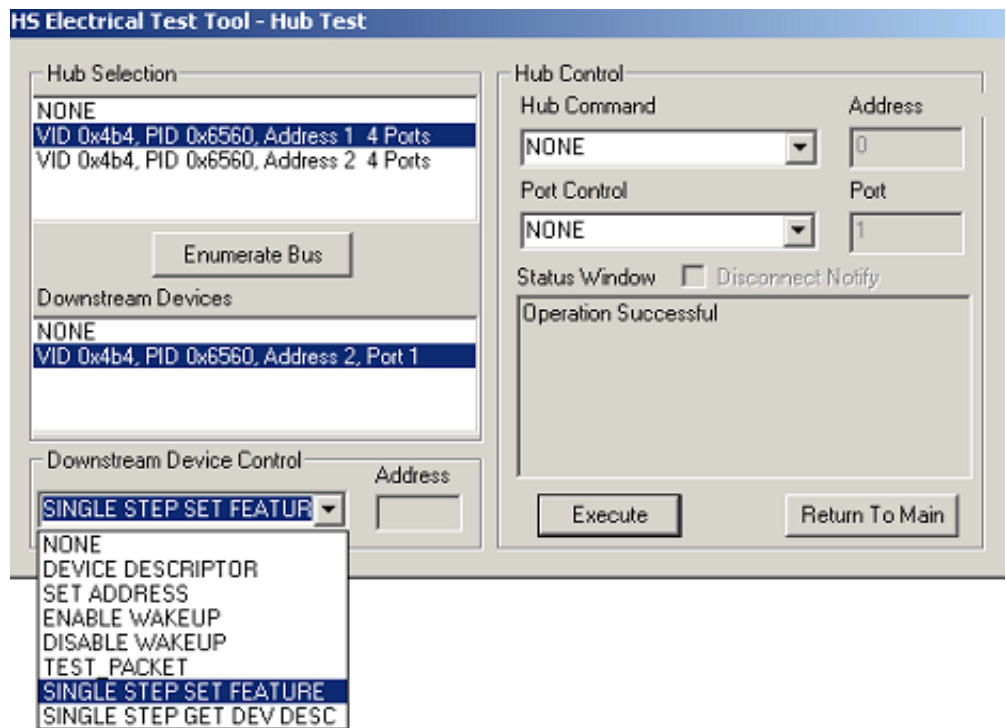

- 2 The captured transition should be as in the figure below.

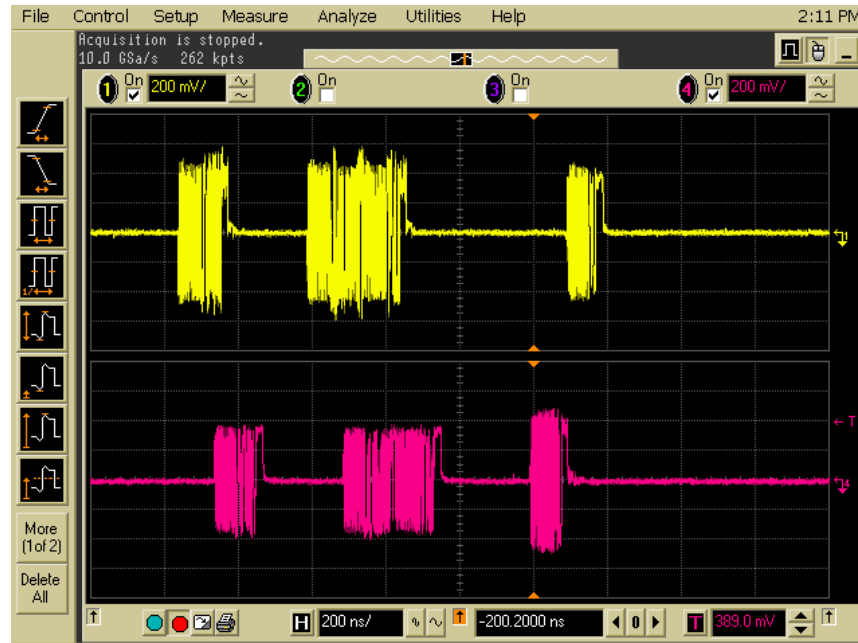

- 3 Check **I have completed these instructions.**

EL_42 EL_43 Measure Truncated Bits from Repeated SYNC Field

EL_44 EL_45 Measure Repeated EOP Width

Viewing Test Results

- 1 When the Testing Complete dialog appears, click **OK**.
The Results tab shows the test results.

Hub CHIRP Timing - Upstream Facing Port

Equipment Used

Table 24 Equipment Used in Hub CHIRP Timing - Upstream Facing Port

Quantity	Item	Description/Model
1	Oscilloscope	Keysight S-Series, 9000A, 90000A, MXR, or UXR Series
2	Probe type	Passive probe
1	Host test bed computer	Any computer with hi-speed USB ports
1	Device Hi-Speed Signal Quality test fixture	Keysight E2666B
1	5 meter USB 2.0 hi-speed cable	Any listed on USB-IF web site

Selecting the Tests

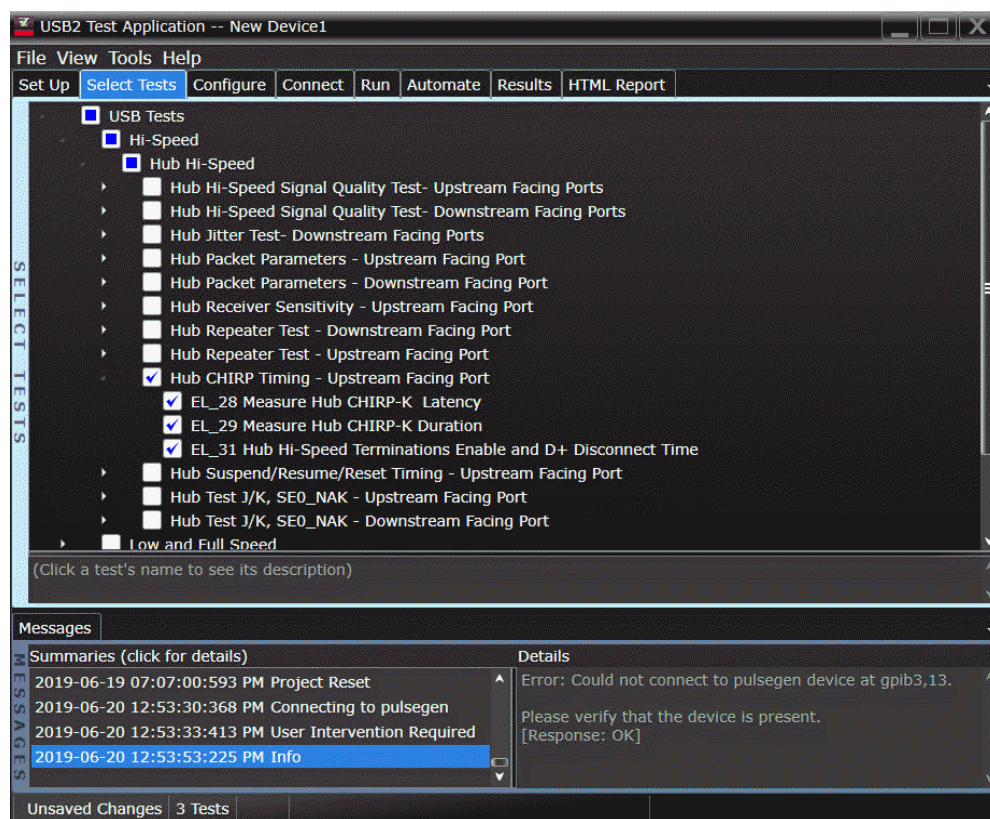

Configuring the Tests

Connecting the Equipment

The USB automated test application will prompt you to perform these connection steps:

- 1 Connect a high impedance adapter with passive probe on Channel 2 to the D- pin at TP2 of the E2649-26401 (E2645-66507 if you are using the old test fixture) Device Hi-Speed Signal Quality test fixture.
- 2 Connect a high impedance adapter with passive probe on Channel 3 to the D+ pin at TP2.
- 3 Connect both probe grounds to GND leads.
- 4 Connect the [INIT PORT] of the test fixture into the host controller port, using the 5-meter USB cable.
- 5 Connect the [TEST PORT] on the fixture to the upstream port of the hub.
- 6 Apply power to the hub. Do not apply 5V to the test fixture.

NOTE

1. If you are using E2649-26401/E2649-26402/E2649-26403, please terminate the SMA connector with 50 Ohm terminators.
2. E2697A is not needed for DSO9000 series oscilloscope.

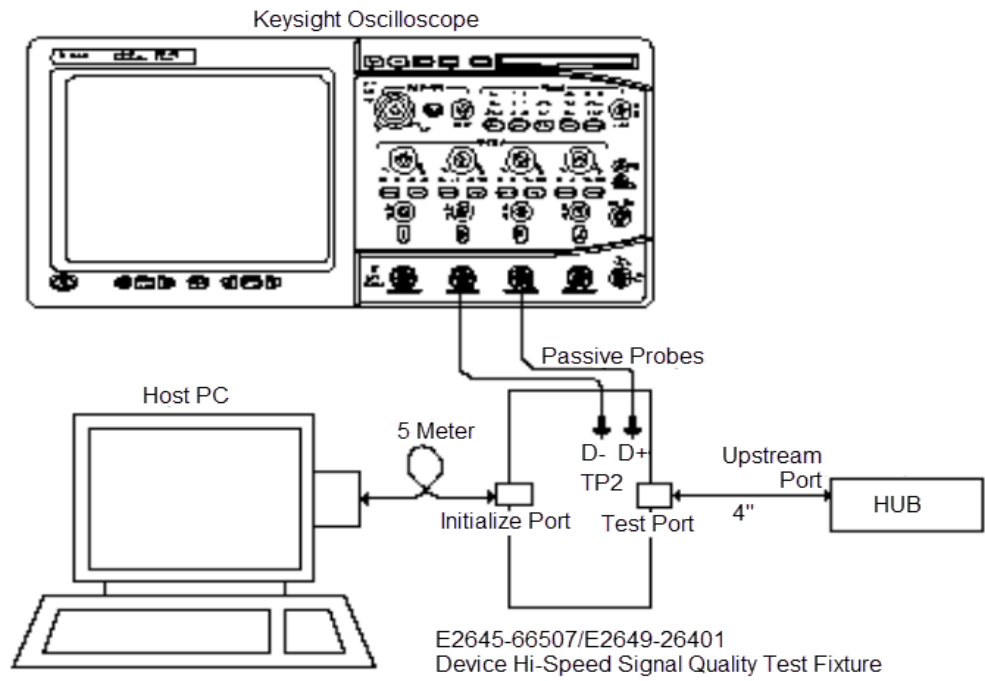

7 Check **I have completed these instructions.**

Running the Tests

- 1 Click **Run Tests**.

Test Instructions

The USB automated test application will prompt you to perform these steps:

- 1 On the HS Electrical Test Tool software, click [**Enumerate Bus**] once. You should capture the CHIRP handshake as in the below figure.

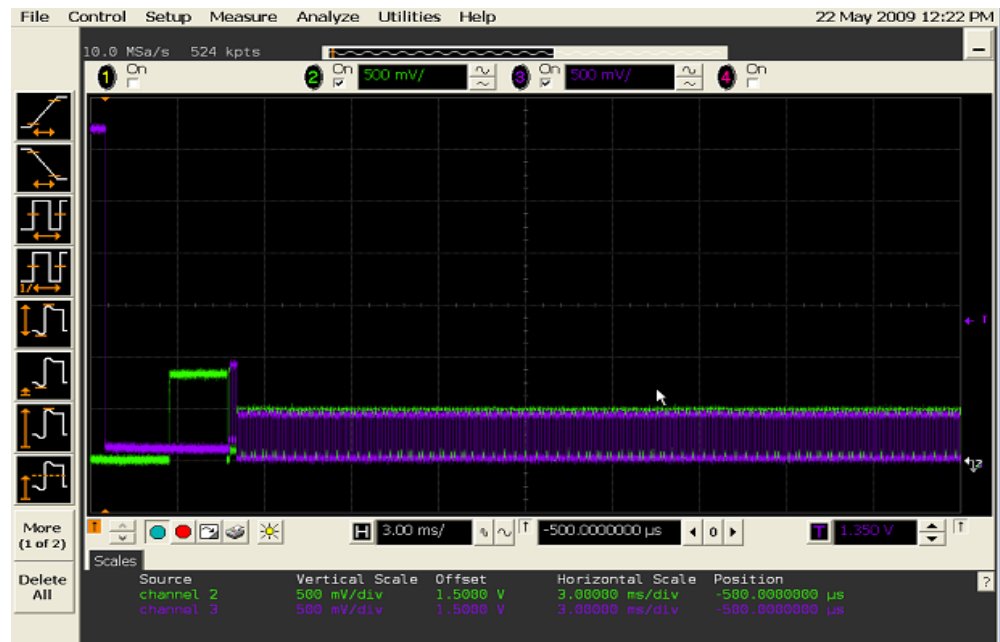

- 2 Click **OK** to close the Test Instructions dialog.

EL_28 Measure Hub CHIRP-K Latency

EL_29 Measure Hub CHIRP-K Duration

EL_31 Hi-Speed Terminations Enable and D+ Disconnect Time

Viewing Test Results

- 1 When the Testing Complete dialog appears, click **OK**.
The Results tab shows the test results.

Hub Suspend/Resume/Reset Timing - Upstream Facing Port

Equipment Used

Table 25 Equipment Used in Hub Suspend/Resume/Reset - Upstream Facing Port

Quantity	Item	Description/Model
1	Oscilloscope	Keysight S-Series, 9000A, 90000A, MXR, or UXR Series
2	Probe type	Passive probe
1	Host test bed computer	Any computer with hi-speed USB ports
1	Device Hi-Speed Signal Quality test fixture	Keysight E2666B
1	5 meter USB 2.0 hi-speed cable	Any listed on USB-IF web site

Selecting the Tests

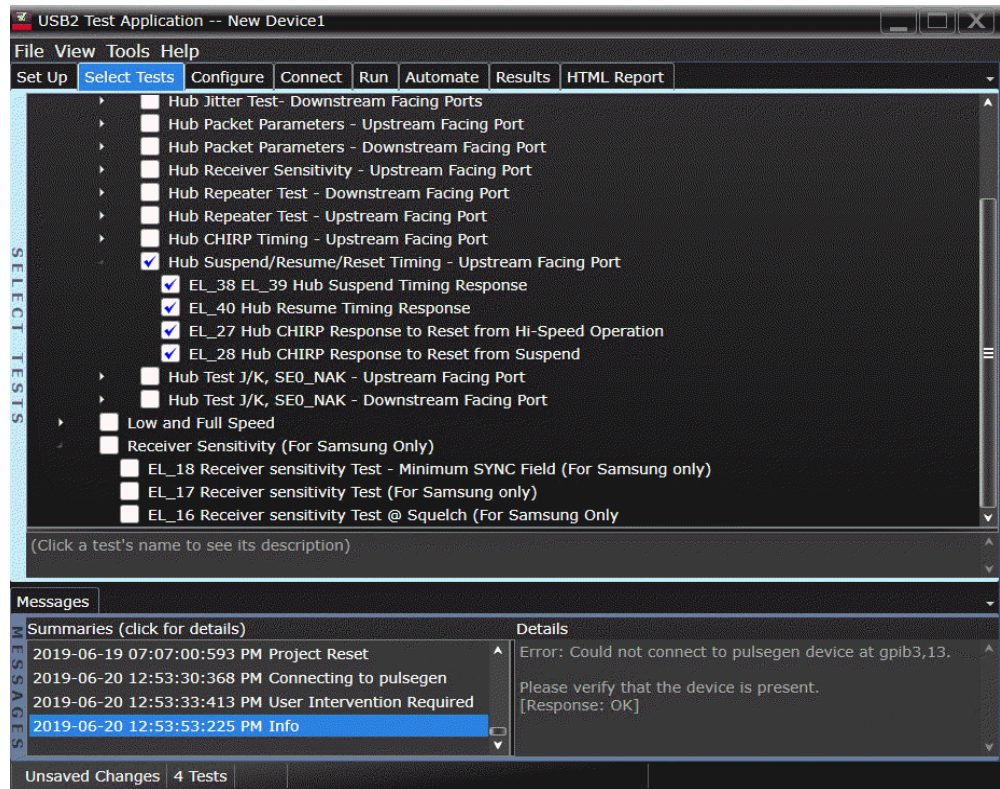

Configuring the Tests

Connecting the Equipment

The USB automated test application will prompt you to perform these connection steps:

- 1 Connect a high impedance adapter with passive probe on Channel 2 to the D- pin at TP2 of the E2649-26401 (E2645-66507 if you are using the old test fixture) Device Hi-Speed Signal Quality test fixture.
- 2 Connect a high impedance adapter with passive probe on Channel 3 to the D+ pin at TP2.
- 3 Connect both probe grounds to leads COM (leads TP5 on the old fixture).
- 4 Connect the [INIT PORT] of the test fixture into the host controller port, using the 5-meter USB cable.
- 5 Connect the [TEST PORT] on the fixture to the upstream port of the hub.
- 6 Apply power to the hub. Do not apply 5V to the test fixture.

NOTE

1. If you are using E2649-26401/E2649-26402/E2649-26403, please terminate the SMA connector with 50 Ohm terminators.
2. E2697A is not needed for DSO9000 series oscilloscope.

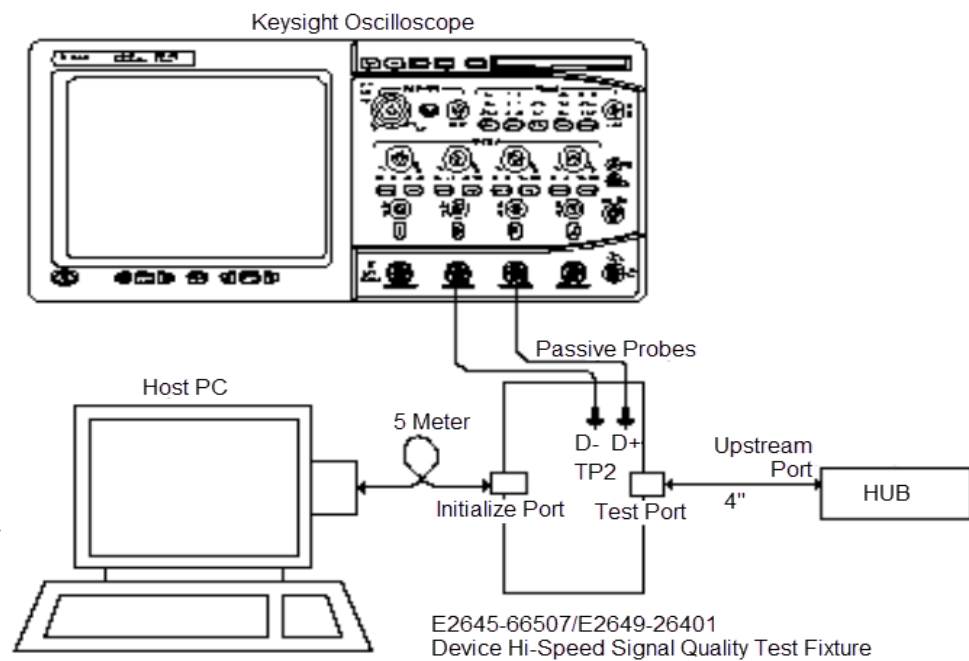

- 7 Check **I have completed these instructions.**

Running the Tests

- 1 Click **Run Tests**.

Test Instructions

EL_38 EL_39 Suspend Timing Response

The USB automated test application will prompt you to perform these steps:

- 1 On the Hub Test menu of the HS Electrical Test Tool software, click **[Enumerate Bus]** once.
- 2 Select SUSPEND from the Hub Command drop down menu. Click **[EXECUTE]** once to place the device into suspend. The captured transition should be as in the figure below.

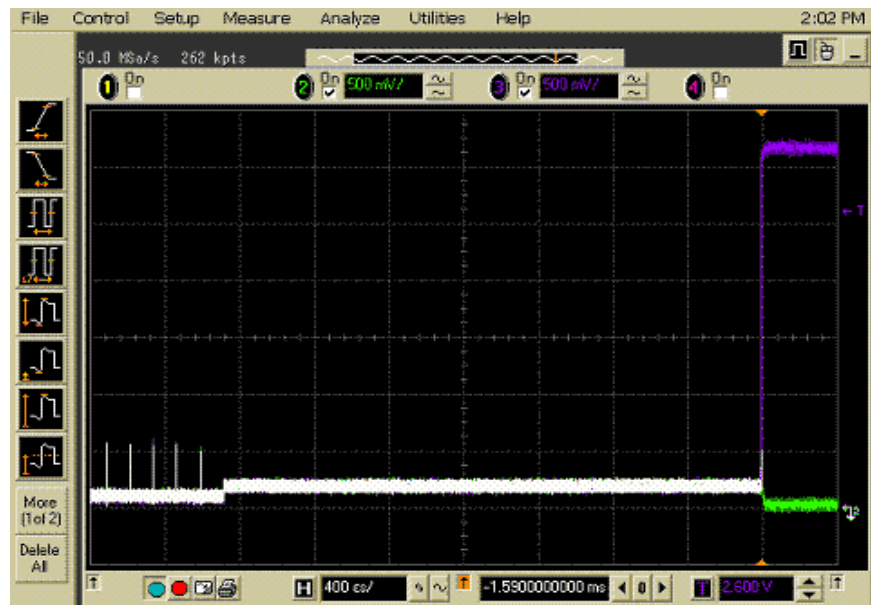
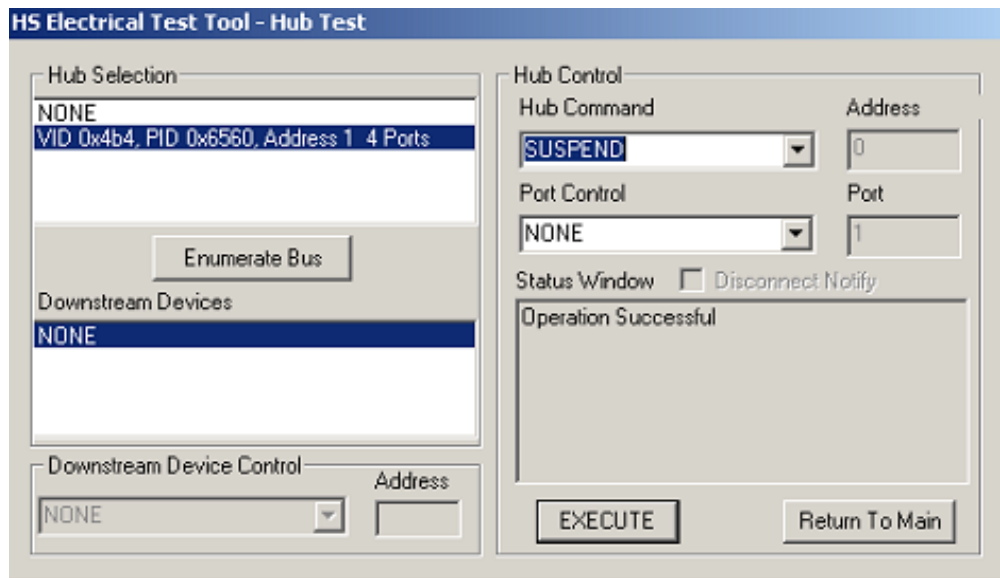

- 3 Click **OK** to close the Test Instructions dialog.

EL_40 Resume Timing Response

The USB automated test application will prompt you to perform these steps:

- 1 On the Hub Test menu of the HS Electrical Test Tool, select **RESUME** from the Hub Command drop down menu. Click **[EXECUTE]** once to resume the hub from suspend. The captured transition should be as in the figure below.

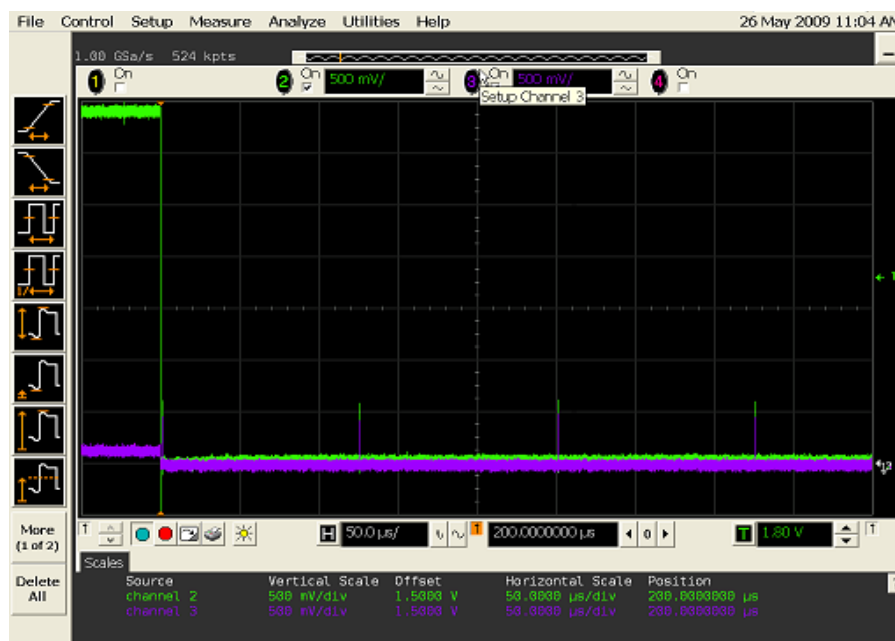
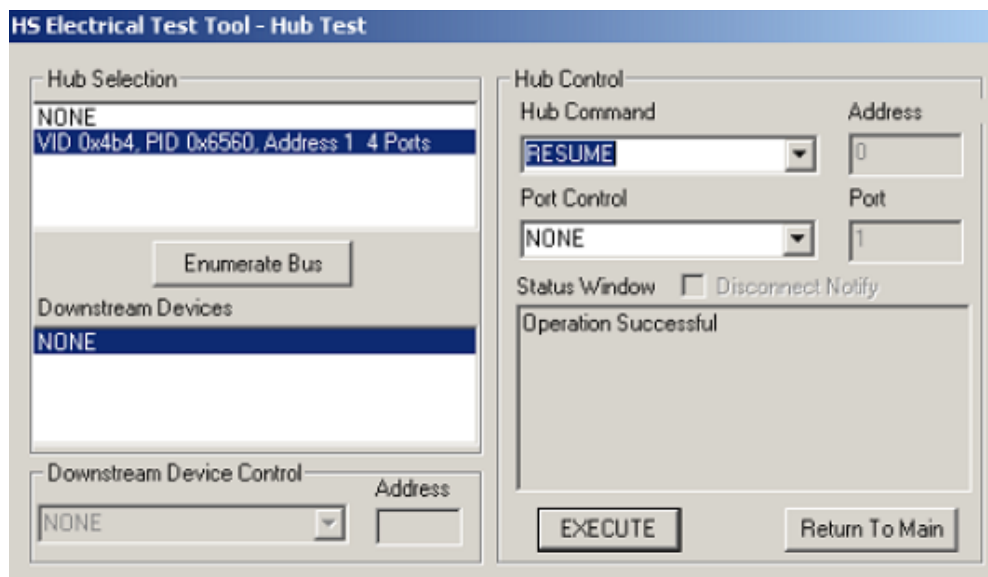

- 2 Click **OK** to close the Test Instructions dialog.

EL_27 Hub CHIRP Response to Reset from Hi-Speed Operation

The USB automated test application will prompt you to perform these steps:

- 1 On the Hub Test menu of the HS Electrical Test Tool, select **RESET** from the Hub Command drop down menu. Click **[EXECUTE]** once to reset the hub operating in high speed. The captured transition should be as in the figure below.

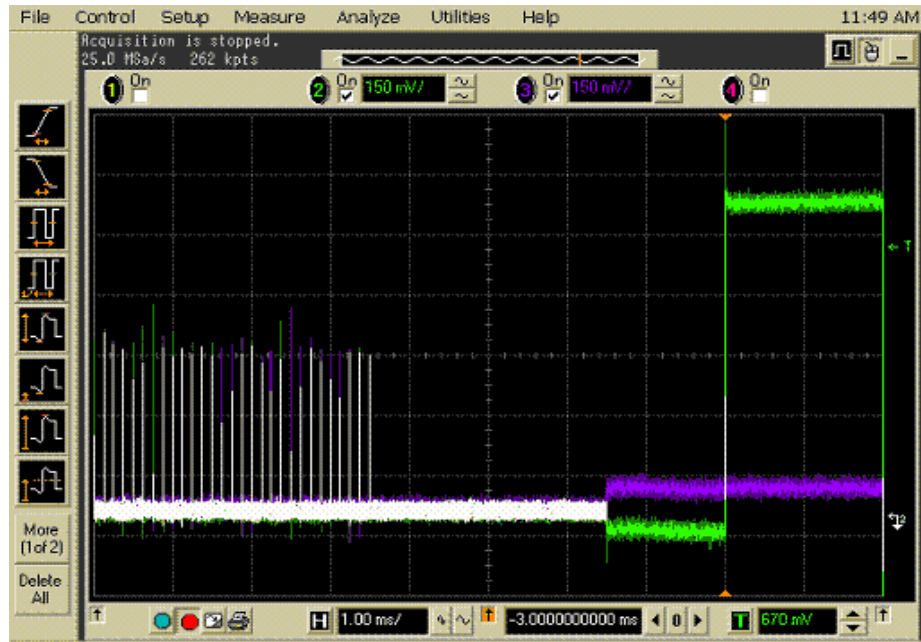
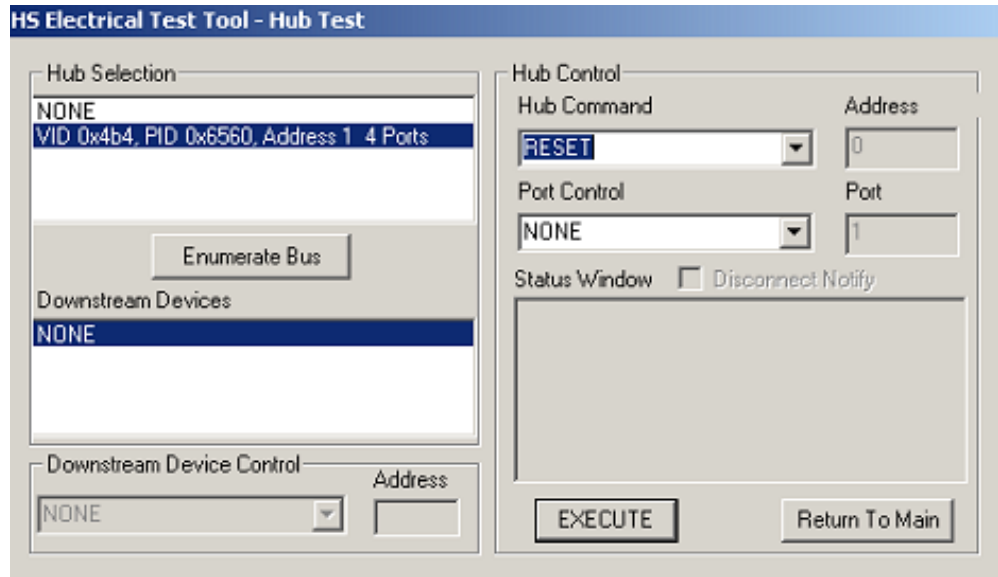

- 2 Click **OK** to close the Test Instructions dialog.

EL_28 Hub CHIRP Response to Reset from Suspend

The USB automated test application will prompt you to perform these steps:

- 1 On the Hub Test menu of the HS Electrical Test Tool software, select **SUSPEND** from the Hub Command drop down menu. Click **[EXECUTE]** once to place the device into suspend.

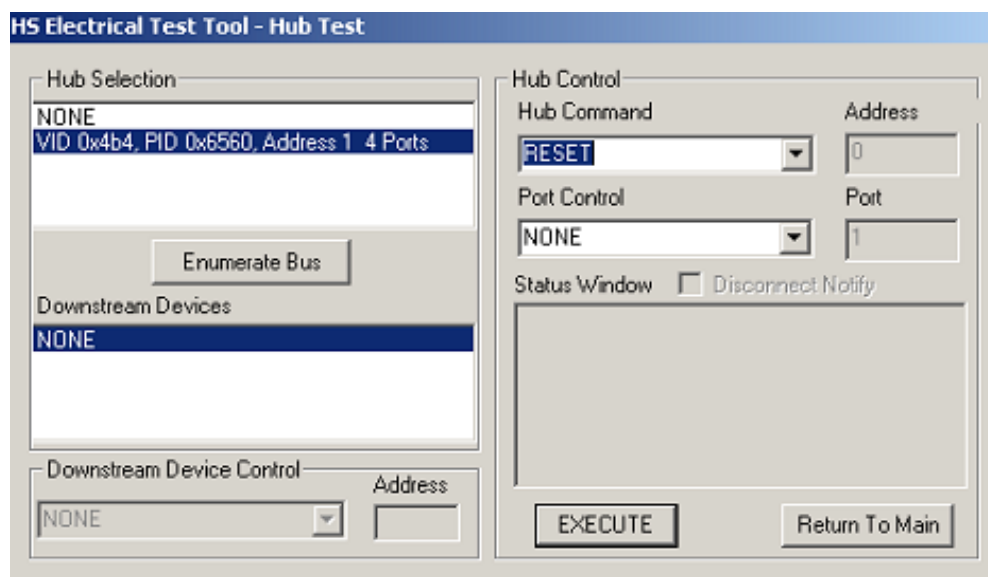

- 2 Click **OK** to close the Test Instructions dialog.

The USB automated test application will prompt you to perform these steps:

- 1 On the Device Test Menu of the HS Electrical Test Tool, select **RESET** from the Device Command drop down menu. Click **[EXECUTE]** once to reset the device operating in high speed. The captured transition should be as in the figure below.

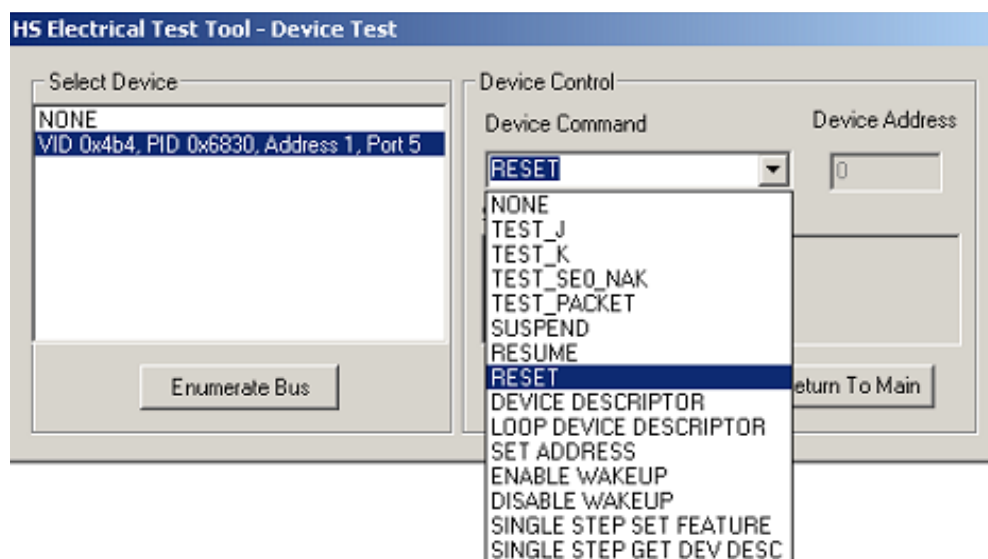

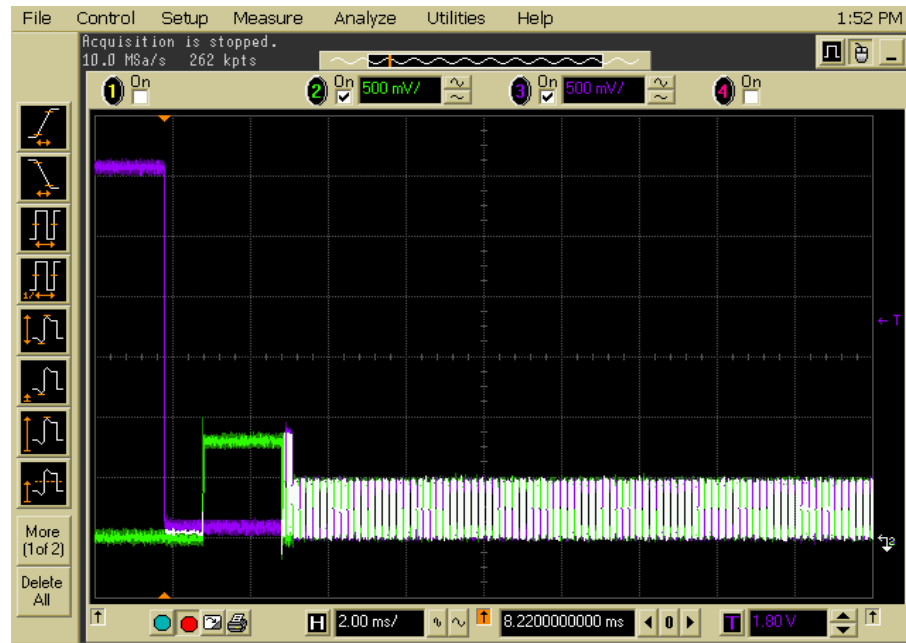

- 2 Click **OK** to close the Test Instructions dialog.

Viewing Test Results

- 1 When the Testing Complete dialog appears, click **OK**.
The Results tab shows the test results.

Hub Test J/K, SEO_NAK - Upstream Facing Port

Equipment Used

Table 26 Equipment Used in Hub Test J/K, SEO_NAK - Upstream Facing Port

Quantity	Item	Description/Model
1	Digital Multimeter (DMM)	Keysight 34401A, 34461A, or equivalent
1	Host test bed computer	Any computer with hi-speed USB ports
1	Device Hi-Speed Signal Quality test fixture and 4" USB cable	Keysight E2666B
1	5V power supply	Keysight 8121-1966 or equivalent
1	5 meter USB 2.0 hi-speed cable	Any listed on USB-IF web site

Selecting the Tests

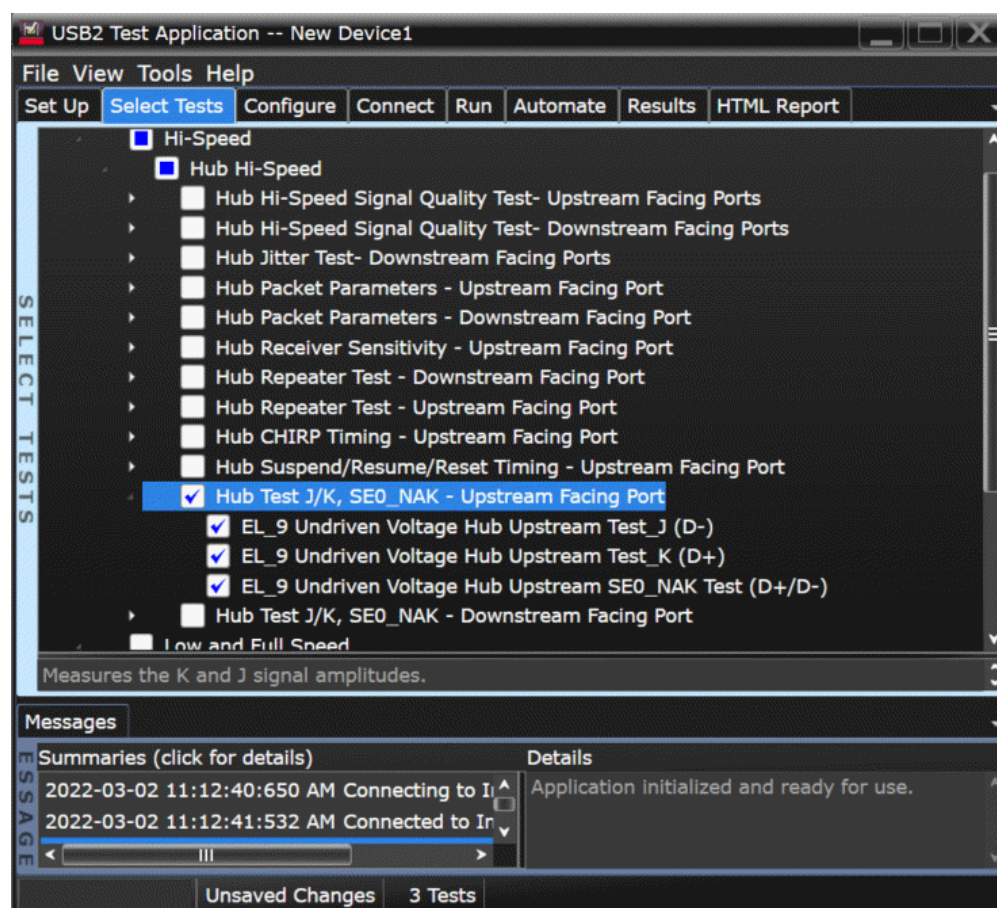

Configuring the Tests

Connecting the Equipment (Using Probe)

The USB automated test application will prompt you to perform these connection steps:

- 1 Attach the 5V power supply to J5 of the E2649-26401 (E2645-66507 if you are using the old test fixture) Device High-Speed Signal Quality test fixture. Leave the TEST switch at the **OFF** position. Verify the green Power LED(D1) is lit, and the yellow Test LED(D2) is off.
- 2 Connect the [TEST PORT] of the test fixture into the upstream facing port of the hub under test, using the 4" USB cable.
- 3 Connect the [INIT PORT] of the test fixture to a port of the Test Bed Computer, using the 5 meter cable.
- 4 Apply power to the hub.
- 5 Connect Channel 1 to D+ and Channel 3 to D- using SMA cable.

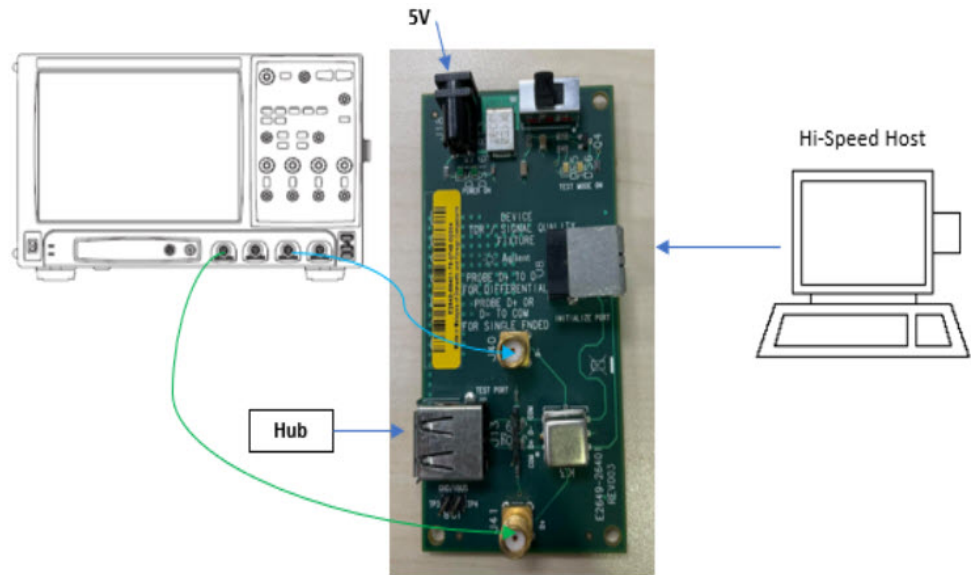

- 6 Check **I have completed these instructions.**

Connecting the Equipment (Using Voltmeter)

The USB automated test application will prompt you to perform these connection steps:

- 1 Attach the 5V power supply to J5 of the E2649-26401 (E2645-66507 if you are using the old test fixture) Device High-Speed Signal Quality test fixture. Leave the TEST switch at the OFF position. Verify the green Power LED(D1) is lit, and the yellow Test LED(D2) is off.
- 2 Connect the [TEST PORT] of the test fixture into the upstream facing port of the hub under test, using the 4" USB cable.
- 3 Connect the [INIT PORT] of the test fixture to a port of the Test Bed Computer, using the 5 meter cable.
- 4 Apply power to the hub.
- 5 Using a [Voltmeter] for voltage measurement.

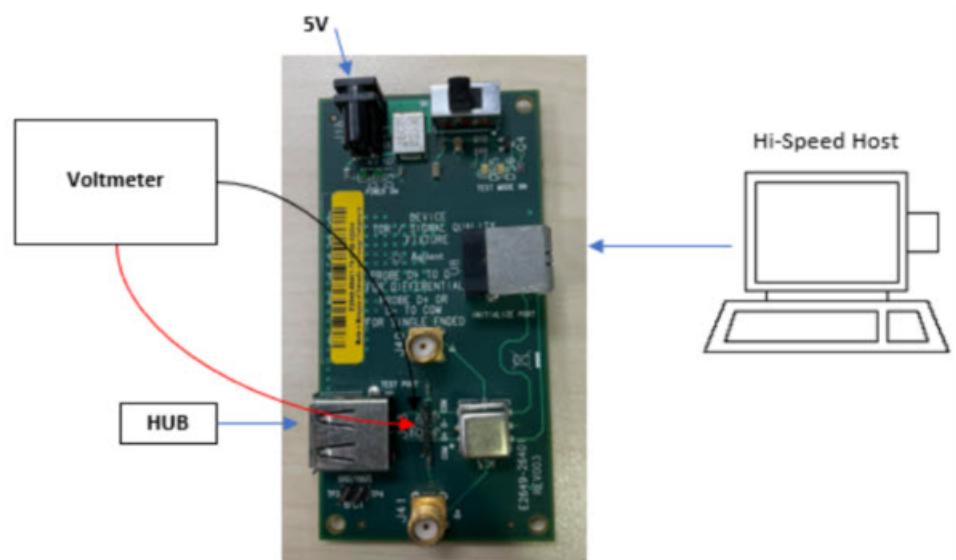

- 6 Check **I have completed these instructions.**

Running the Tests

- 1 Click **Run Tests**.

Test Instructions

EL_9 Undriven Voltage Hub Upstream Test_J (D-) Test

The USB automated test application will prompt you to perform these steps:

- 1 On the Hub Test menu of the HS Electrical Test Tool, click **[Enumerate Bus]** once.
- 2 Select **TEST_J** from the Hub Command drop down menu. Click **[EXECUTE]** once to place the hub into TEST_J test mode.
- 3 Switch the test fixture into the **TEST** position.

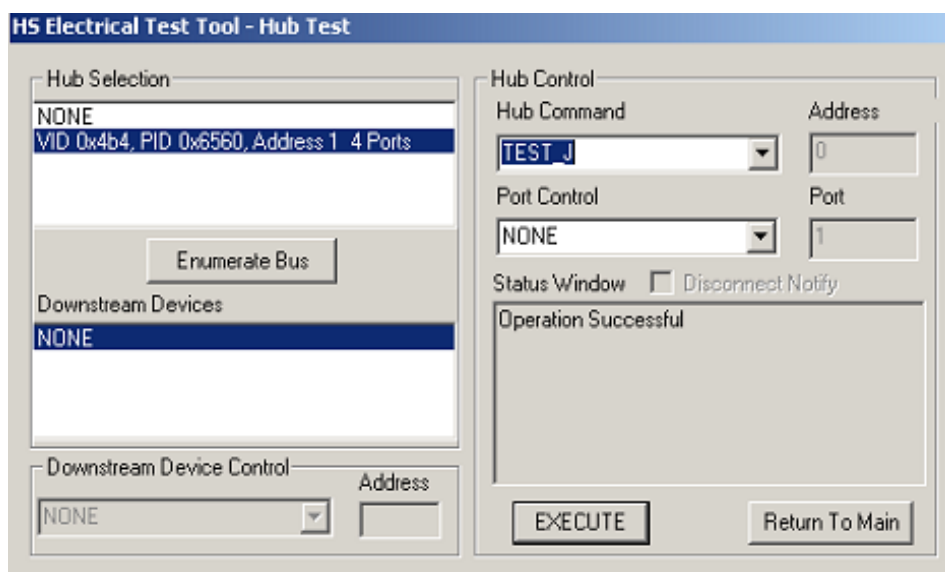

- 4 Click **OK** to close the Test Instructions dialog.

The USB automated test application will prompt you for the following voltage measurements:

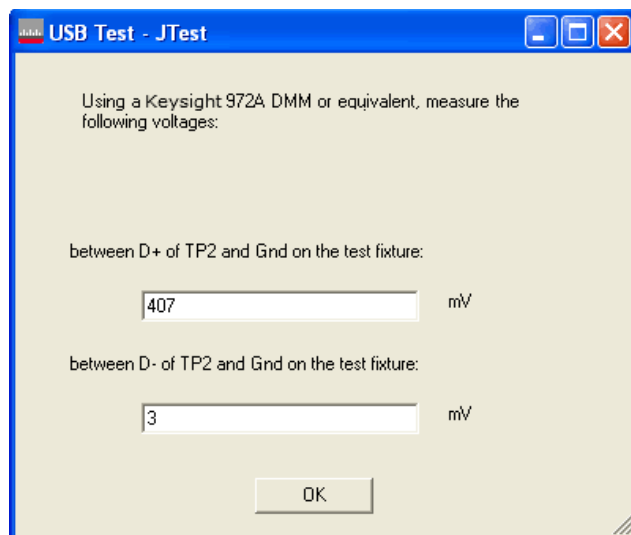

EL_9 Undriven Voltage Hub Upstream Test_K (D+) Test

The USB automated test application will prompt you to perform these steps:

- 1 Return the Test switch of the test fixture to the **NORMAL** position.
- 2 Cycle the hub power to restore the hub to normal operation. On the Hub Test menu of the HS Electrical Test Tool, click [**Enumerate Bus**] once.
- 3 Select **TEST_K** from the Hub Command drop down menu. Click [**EXECUTE**] once to place the hub into TEST_K test mode.
- 4 Switch the test fixture into the **TEST** position.

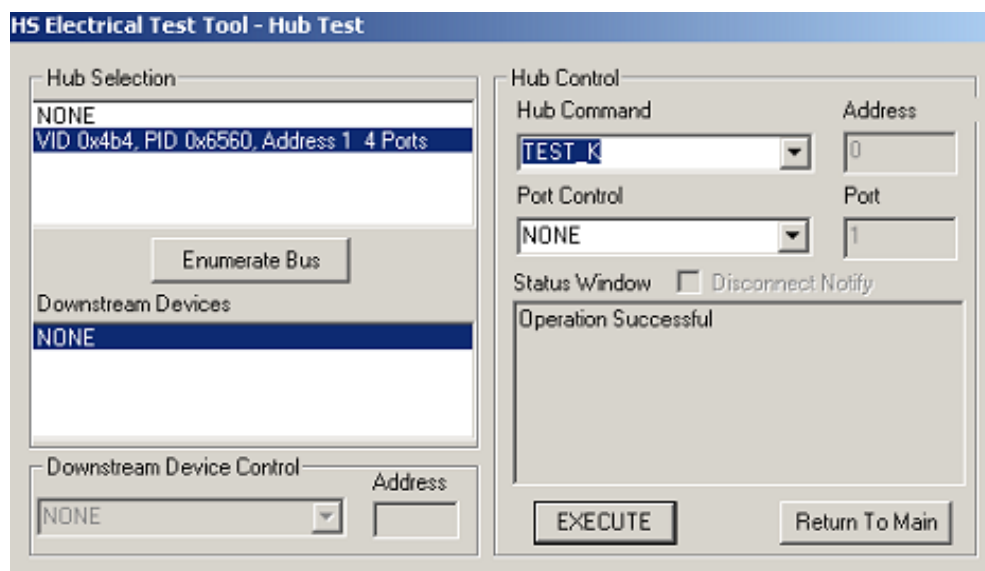

- 5 Click **OK** to close the Test Instructions dialog.

The USB automated test application will prompt you for the following voltage measurements:

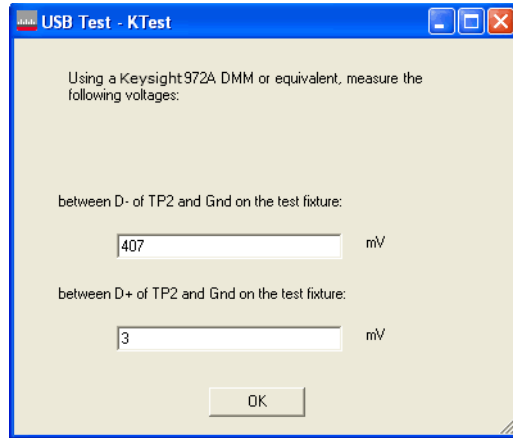

EL_9 Undriven Voltage Hub Upstream SE0_NAK Test (D+/D-) Test

The USB automated test application will prompt you to perform these steps:

- 1 Return the Test switch of the test fixture to the **NORMAL** position.
- 2 Cycle the hub power to restore the hub to normal operation. On the Hub Test menu of the HS Electrical Test Tool, click **[Enumerate Bus]** once.
- 3 Select **TEST_SE0_NAK** from the Hub Command drop down menu. Click **[EXECUTE]** once to place the hub into TEST_SE0_NAK test mode.
- 4 Switch the test fixture into the **TEST** position.

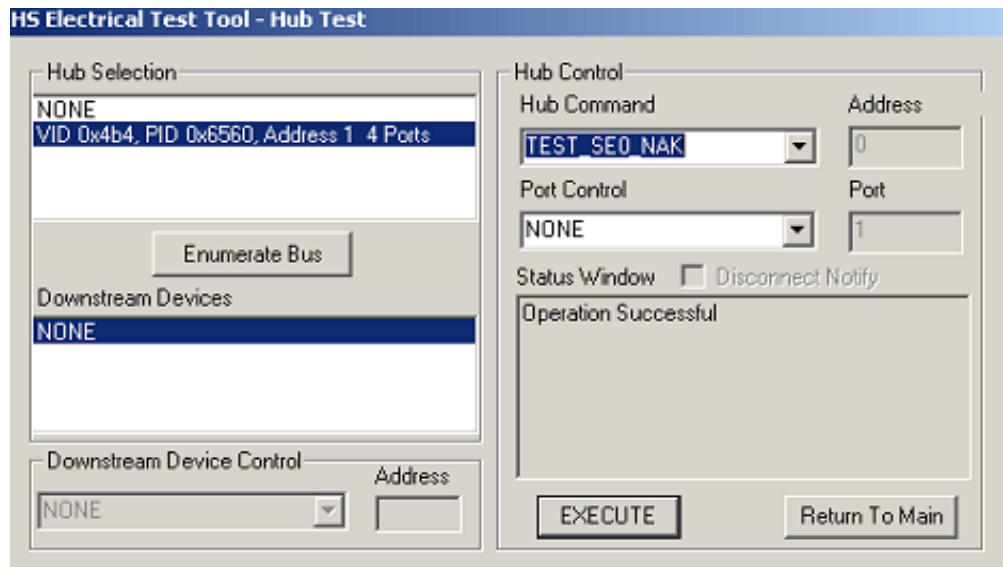

- 5 Click **OK** to close the Test Instructions dialog.

The USB automated test application will prompt you for the following voltage measurements:

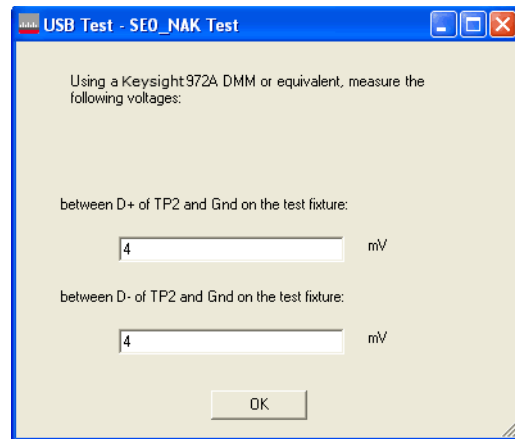

Viewing Test Results

- 1 When the Testing Complete dialog appears, click **OK**.
The Results tab shows the test results.

Hub Test J/K, SEO_NAK - Downstream Facing Port

Equipment Used

Table 27 Equipment Used in Hub Test J/K, SEO_NAK - Downstream Facing Port

Quantity	Item	Description/Model
1	Digital Multimeter (DMM)	Keysight 34401A, 34461A, or equivalent
1	Host test bed computer	Any computer with hi-speed USB ports
1	Host Hi-Speed Signal Quality test fixture and 4" USB cable	Keysight E2649-66402 (old fixture P/N E2645-66508)
1	5V power supply	Keysight 8121-1966 or equivalent
1	5 meter USB 2.0 hi-speed cable	Any listed on USB-IF web site

Selecting the Tests

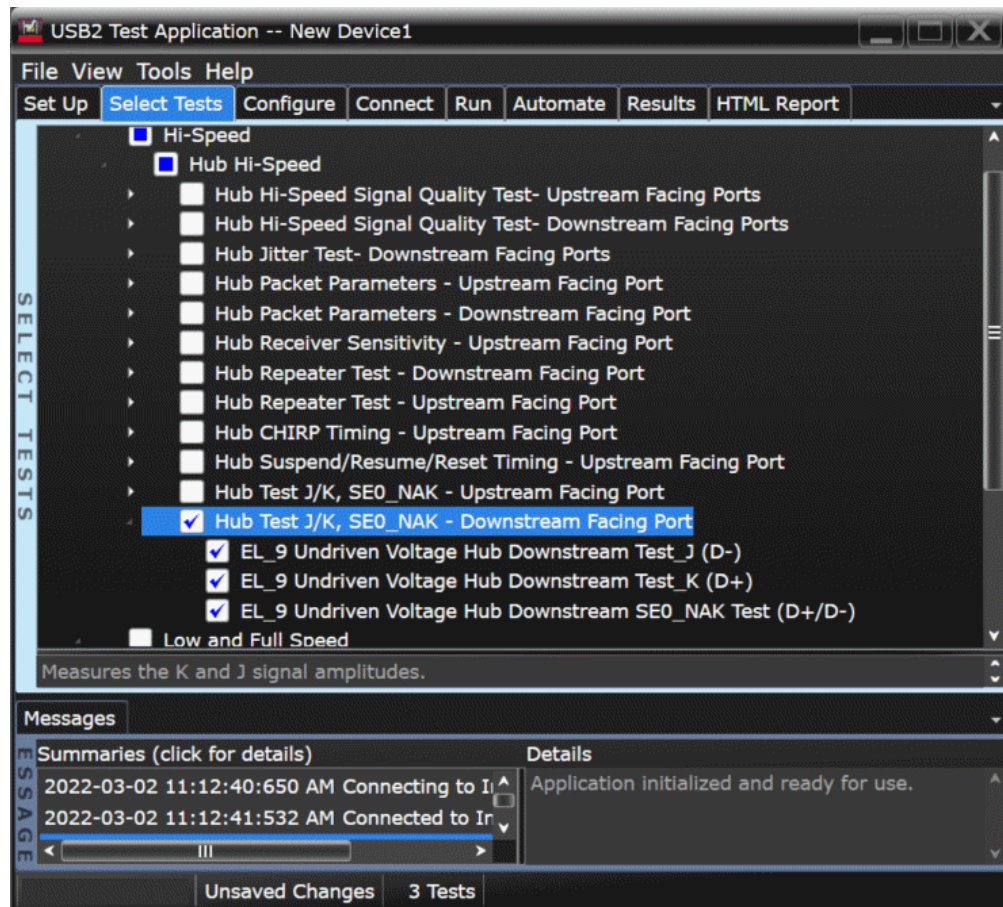

Configuring the Tests

Connecting the Equipment (Using Probes)

The USB automated test application will prompt you to perform these connection steps:

- 1 Attach the 5V power supply to J5 of the E2649-26402 (E2645-66508 if you are using the old test fixture) Host High-Speed Signal Quality test fixture. Verify the green Power LED(D1) is lit. Place the TEST switch (S1) in the Test position and the yellow Test LED(D2) is lit.
- 2 Connect the [TEST PORT] of the test fixture into the downstream facing port of the hub under test, using the 4" USB cable.
- 3 Attach the hub upstream port to the host controller port, using the 5 meter cable.
- 4 Apply power to the hub
- 5 Connect channel 1 to D+ and Channel 3 to D- using [SMA Cable]. .

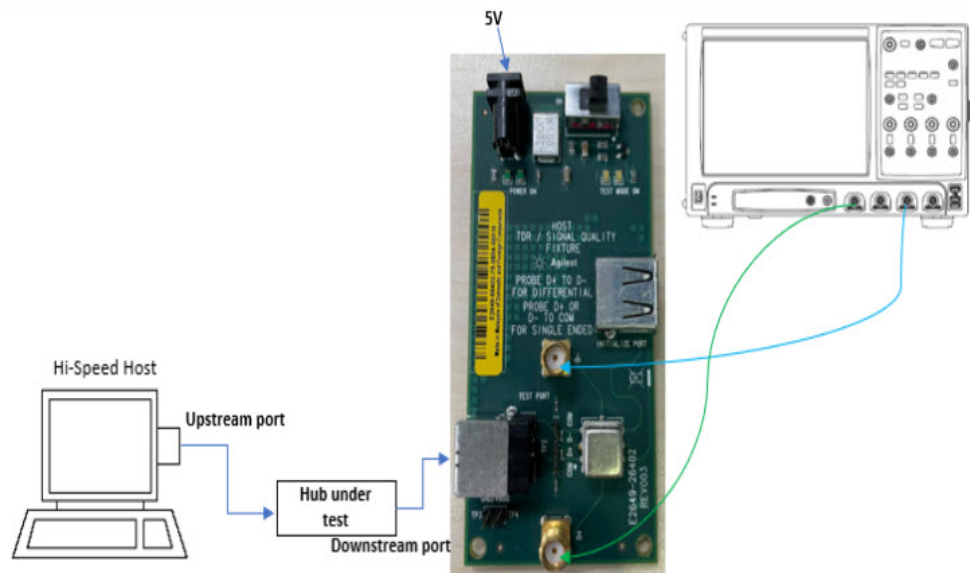

- 6 Check **I have completed these instructions.**

Connecting the Equipment (Using Voltmeter)

The USB automated test application will prompt you to perform these connection steps:

- 1 Attach the 5V power supply to J5 of the E2649-26402 (E2645-66508 if you are using the old test fixture) Host High-Speed Signal Quality test fixture. Verify the green Power LED(D1) is lit. Place the TEST switch (S1) in the Test position and the yellow Test LED(D2) is lit.
- 2 Connect the [TEST PORT] of the test fixture into the downstream facing port of the hub under test, using the 4" USB cable.
- 3 Attach the hub upstream port to the host controller port, using the 5 meter cable.
- 4 Apply power to the hub.
- 5 Using a [Voltmeter] for voltage measurement.

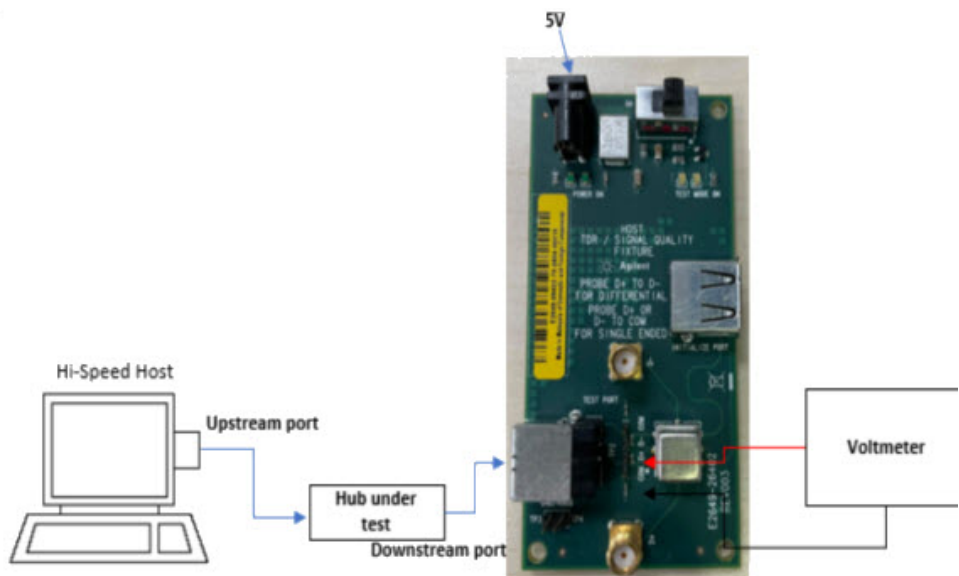

- 6 Check **I have completed these instructions.**

Running the Tests

- 1 Click **Run Tests**.

Test Instructions

EL_9 Undriven Voltage Hub Downstream Test_J (D-) Test

The USB automated test application will prompt you to perform these steps:

- 1 On the Hub Test menu of the HS Electrical Test Tool, click **[Enumerate Bus]** once.
- 2 Select **TEST_J** from the Port Control drop down menu. Enter port number and click **[EXECUTE]** once to place the port under test into TEST_J test mode.

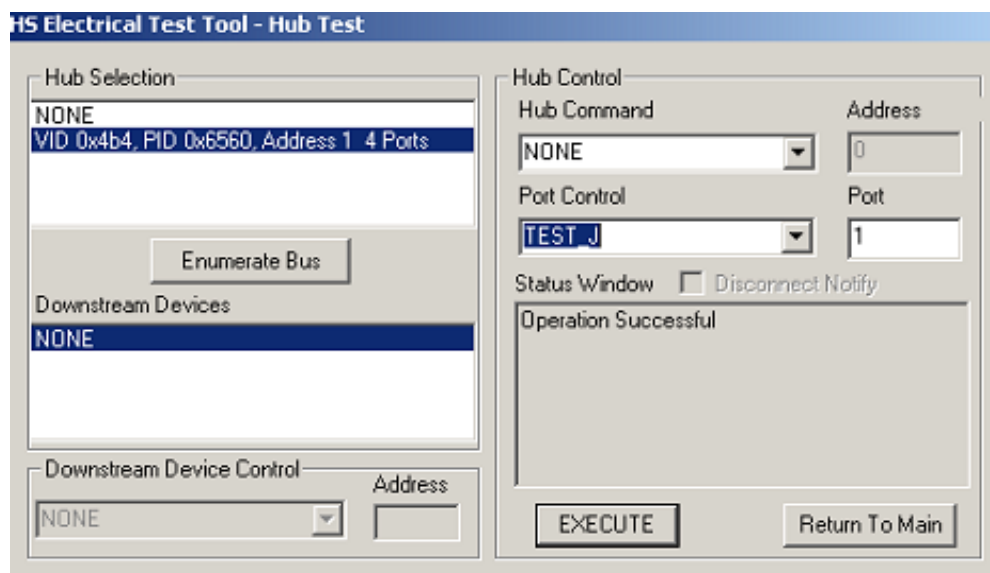

- 3 Click **OK** to close the Test Instructions dialog.

The USB automated test application will prompt you for the following voltage measurements:

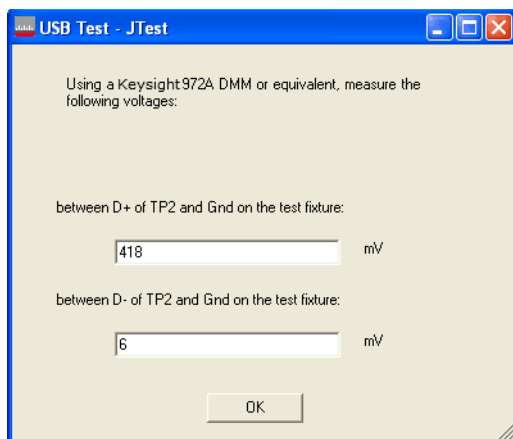

EL_9 Undriven Voltage Hub Downstream Test_K (D+) Test

The USB automated test application will prompt you to perform these steps:

- 1 On the Hub Test menu of the HS Electrical Test Tool, click **[Enumerate Bus]** once.
- 2 Select **TEST_K** from the Port Control drop down menu. Enter port number and click **[EXECUTE]** once to place the port under test into TEST_K test mode.

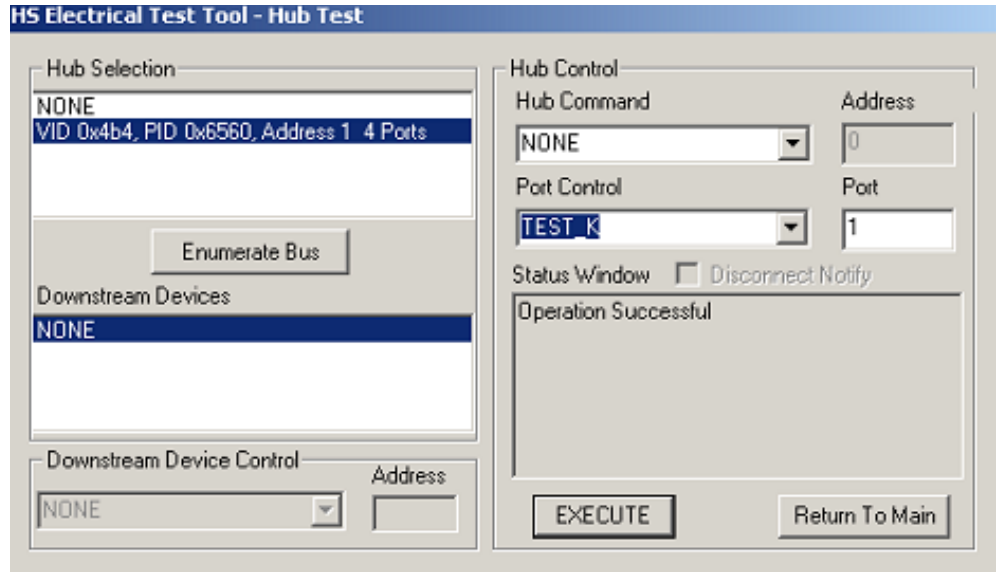

- 3 Click **OK** to close the Test Instructions dialog.

The USB automated test application will prompt you for the following voltage measurements:

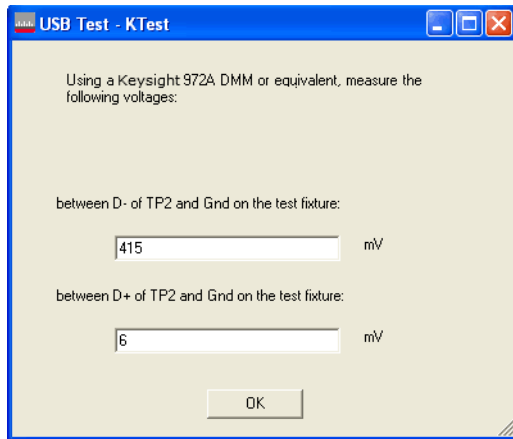

EL_9 Undriven Voltage Hub Downstream SEO_NAK Test (D+/D-) Test

The USB automated test application will prompt you to perform these steps:

- 1 On the Hub Test menu of the HS Electrical Test Tool, click **[Enumerate Bus]** once.
- 2 Select **TEST_SEO_NAK** from the Port Control drop down menu. Enter port number and click **[EXECUTE]** once to place the port under test into TEST_SEO_NAK test mode.

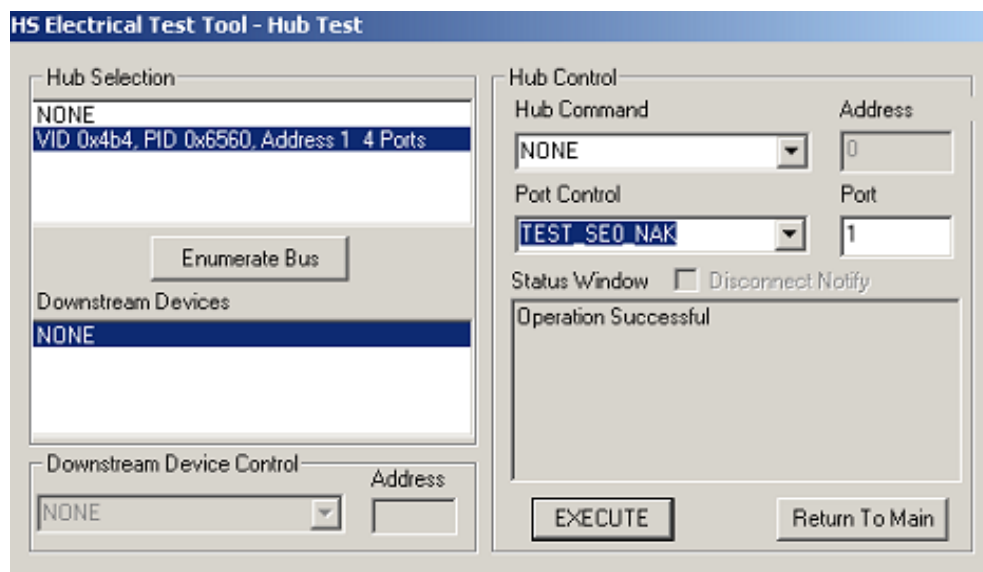

- 3 Click **OK** to close the Test Instructions dialog.

The USB automated test application will prompt you for the following voltage measurements:

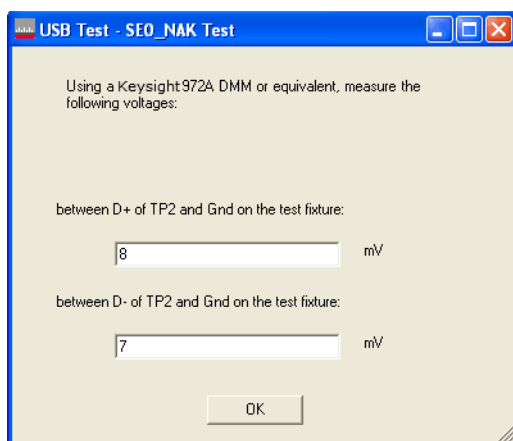

Viewing Test Results

- 1 When the Testing Complete dialog appears, click **OK**.
The Results tab shows the test results.

5 Host Hi-Speed Electrical Tests

Host Hi-Speed Signal Quality	151
Host Controller Packet Parameters	157
Host CHIRP Timing	165
Host Suspend/Resume Timing	169
Host Test J/K, SEO_NAK	174

NOTE

To give the automated test software more flexibility in making corner case measurements (and improve test performance), the oscilloscope's memory upgrade option is recommended (Option 001 when ordered with the oscilloscope, or after purchase: N5472A for the 90000A Series oscilloscopes).

In addition to the hi-speed electrical tests prescribed in this chapter, the host controller under test must also pass the following electrical compliance tests applicable to the EHCI Host Controller:

- Full speed signal quality.
- Low speed signal quality.
- Drop/Droop.

Before Running These Tests

If you haven't already performed the initial equipment set up, see "[Setting Up the Equipment](#)" on page 30.

Selecting the Host Test Environment Setup

- 1 In the USB automated test application, select the **Host** test environment.
- 2 To do automatic testing, select **USBET** as the **Test Method**. To do manual testing, select Both as the **Test Method**. See page 23 for more information.

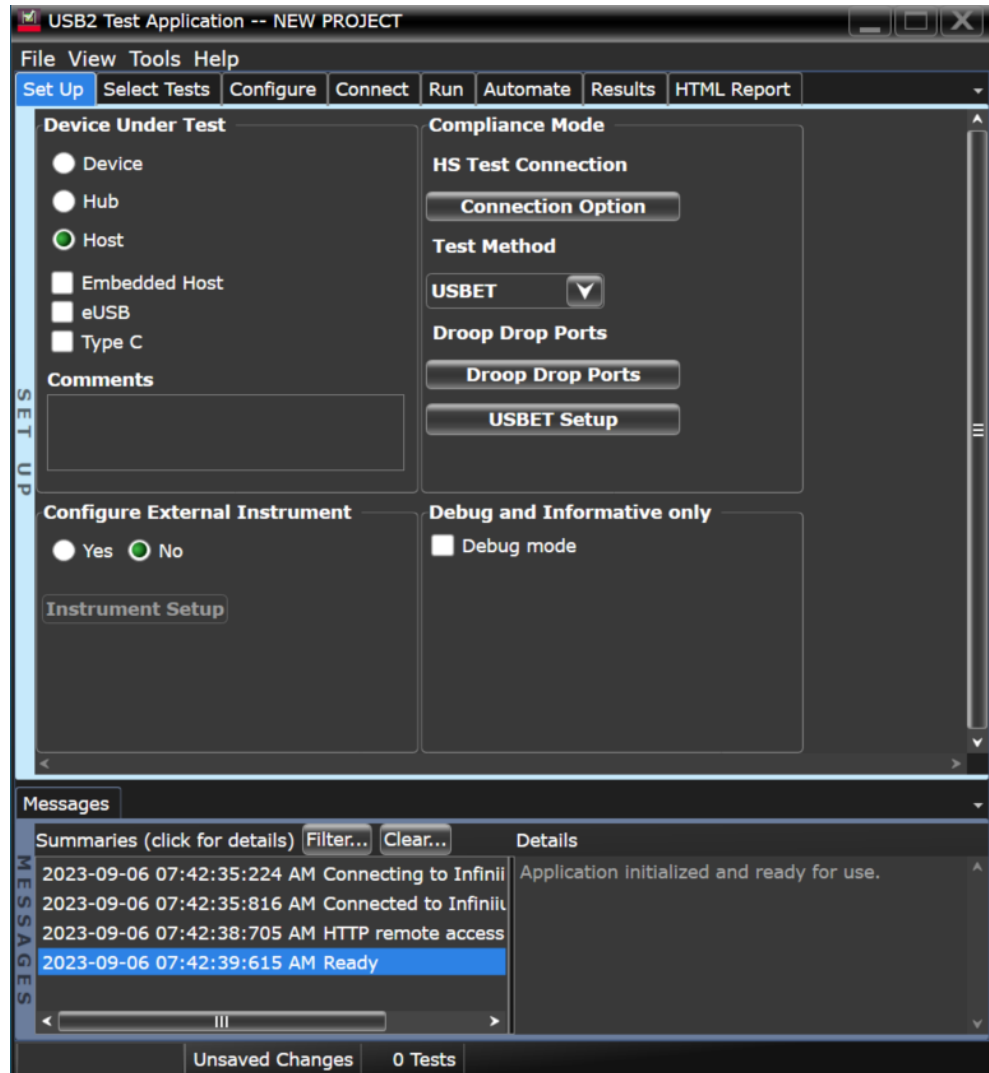

Host Hi-Speed Signal Quality

Equipment Used

Table 28 Equipment Used in Host Hi-Speed Signal Quality Tests

Quantity	Item	Description/Model
1	Oscilloscope	Keysight S-Series, 9000A, 90000A, MXR, or UXR Series
1	Probe type	Differential active (at least 2.5 GHz bandwidth) with E2678B socketed probe head
1	Header adapter (only needed if you are using the old test fixture - E2645-66508)	Keysight 01131-68703
1	Host test bed computer	Any computer with hi-speed USB ports
1	Host Hi-Speed Signal Quality test fixture and 4" USB cable	Keysight E2649-66402 (old fixture P/N E2645-66508)
1	5V power supply	Keysight 8121-1966 or equivalent

Selecting the Tests

Note: To do manual testing, choose **Both** for the **Test Method** option under the **Setup** tab. There will then be several manual tests to choose from under the **Select Test** tab.

NOTE

When eUSB option is selected, in case of Signal Quality tests, the test app applies a different set of test limits, specific to eUSB type DUT.

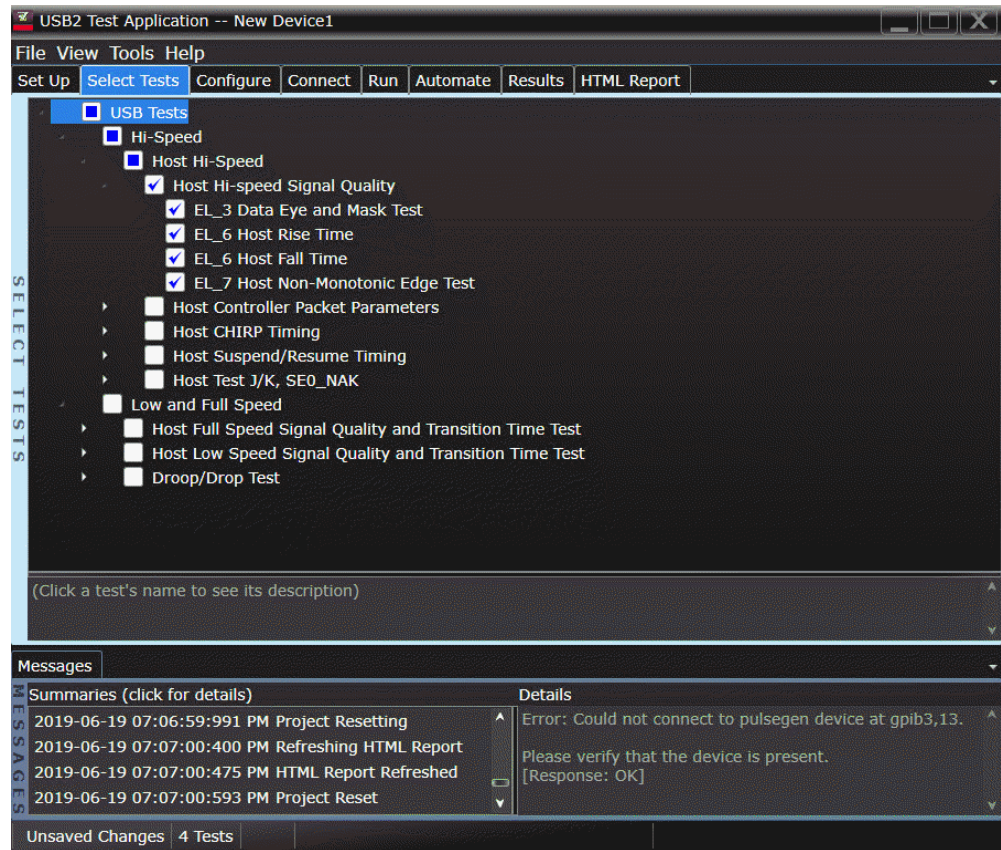

Configuring the Tests

Connecting the Equipment - Differential Connection

The USB automated test application will prompt you to perform these connection steps:

- 1 Attach the 5V power supply to J5 of the E2649-66402 (E2645-66508 if you are using the old fixture) Host Hi-Speed Signal Quality test fixture and verify the green Power LED is lit.
 - a Set the Test switch (S1) of the test fixture to **TEST** and verify the yellow TEST LED is lit.
- 2 Attach a high speed differential probe on Channel 1 to D+ and D- of TP2 of the test fixture, using a compatible header adapter.
- 3 Connect host port under test to the [TEST PORT] of the test fixture using the 4 inch USB cable.

NOTE

1. If you are using E2649-26401/E2649-26402/E2649-26403/E2649-26404 you would not need to use the damped header adapter.
2. If you are using differential test connections for E2649-26401/E2649-26402/E2649-26403, please terminate the SMA connector with 50 Ohm terminators.

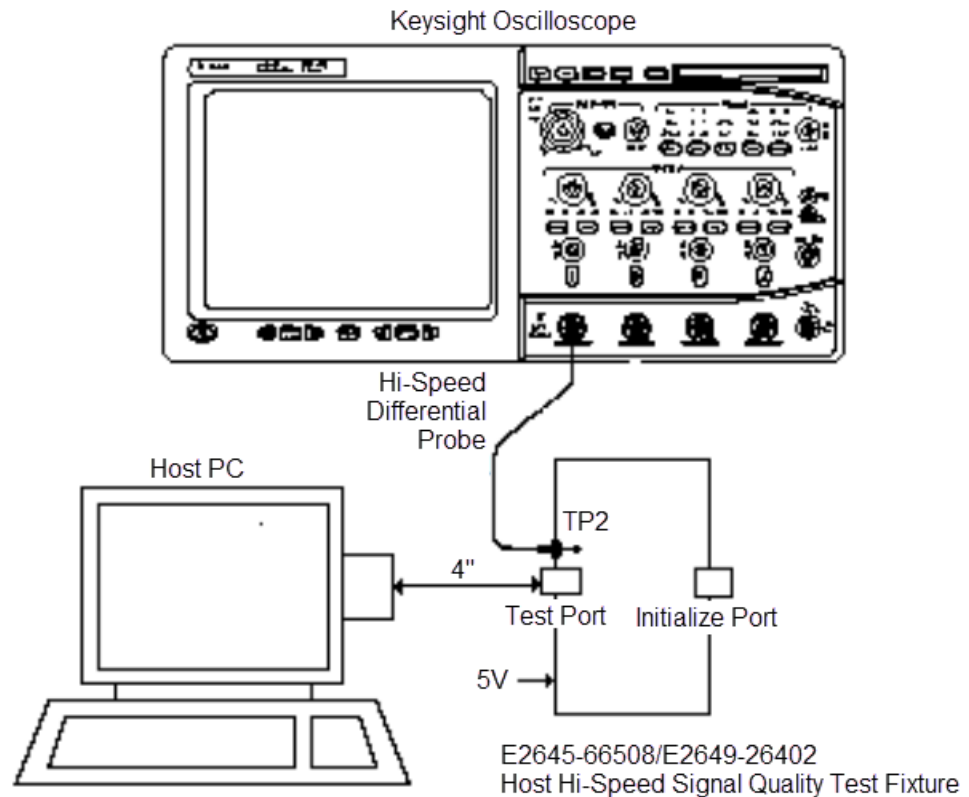

- 4 Check I have completed these instructions.

Connecting the Equipment - Single-Ended Connection

- 1 Attach the 5V power supply to J5 of the E2649-66402 (E2645-66508 if you are using the old fixture) Hi-Speed signal quality test fixture. Verify the green Power LED is lit.
 - a Set the Test switch (S1) of the test fixture to TEST and verify that the yellow TEST LED is lit.
- 2 Attach the SMA cables to SMA connectors D+ and D- on the test fixture.
- 3 Connect host port under test to the [TEST PORT] of the test fixture using the 4 inch USB cable.

NOTE

1. Single-ended connection is only available using E2649-26401/E2649-26402/E2649-26403.
2. If you are using differential test connections for E2649-26401/E2649-26402/E2649-26403, please terminate the SMA connector with 50 Ohm terminators.

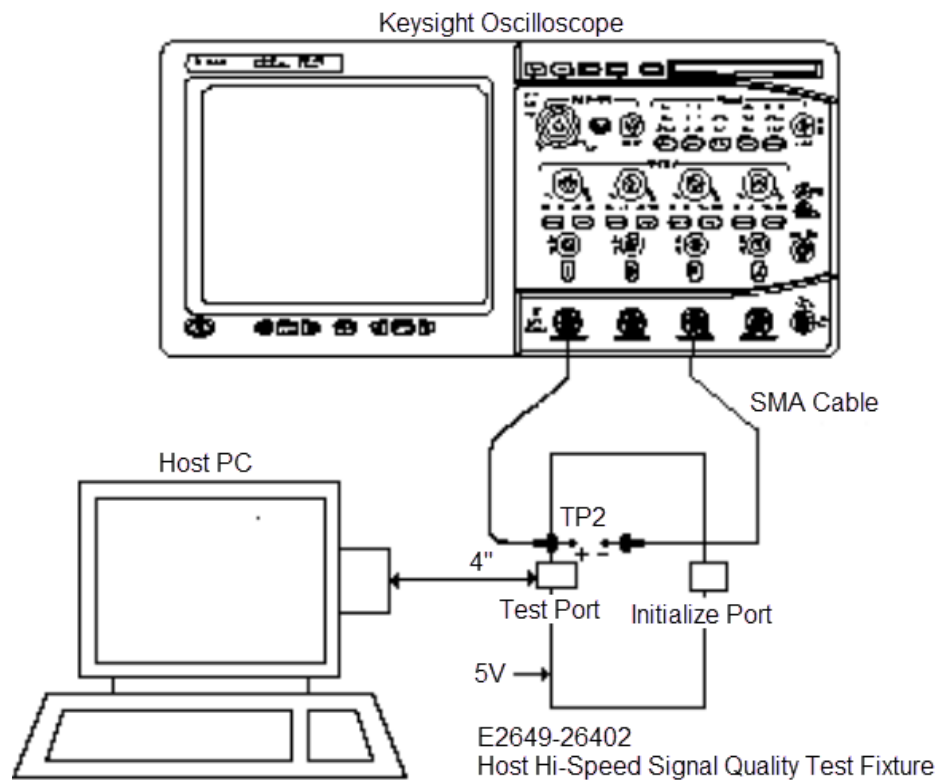

- 4 Check **I have completed these instructions.**

Running the Tests

- 1 Click **Run Tests**.

Test Instructions, Part 1

The USB automated test application will prompt you to perform these steps:

- 1 Invoke the HS Electrical Test Tool software on the Hi-Speed Electrical Test Bed computer.
- 2 Select Host Controller/System and click the **[TEST]** button to enter the Host Test menu.

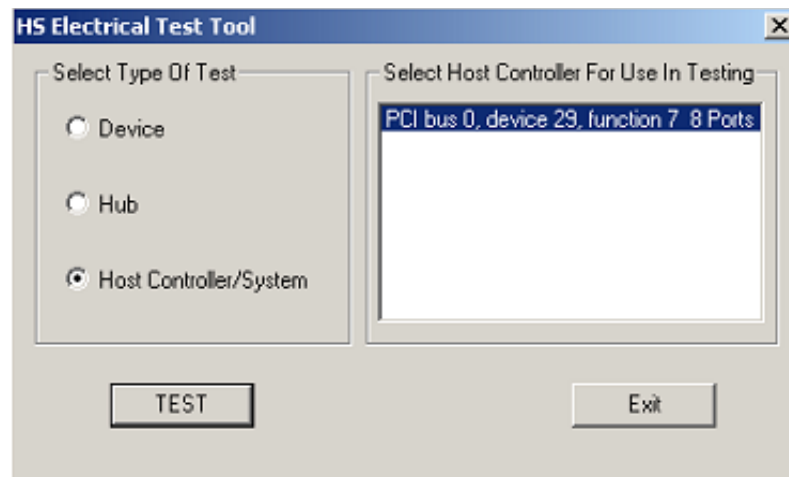

- 3 Click **OK** to close the Test Instructions dialog.

Test Instructions, Part 2

The USB automated test application will prompt you to perform these steps:

- 1 Connect the [TEST PORT] of the E2649-66402 Host Hi-Speed Signal Quality test fixture (E2645-66508 if you are using the old fixture) into the port under test of the host controller, using the 4" USB cable. The host controller here refers to the Hi-speed Electrical Test Bed Computer that has the HS Electrical Test Tool on it.
- 2 Select **TEST_PACKET** from the Port Control drop down menu.
- 3 Enter the port number of the port under test and click **[EXECUTE]**. This forces the port under test to continuously transmit test packets.

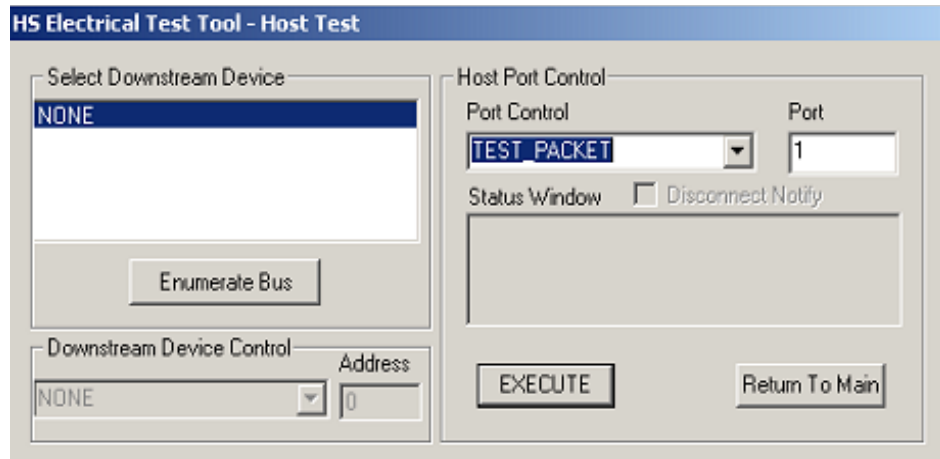

You should see the transmitted test packet on the oscilloscope as below.

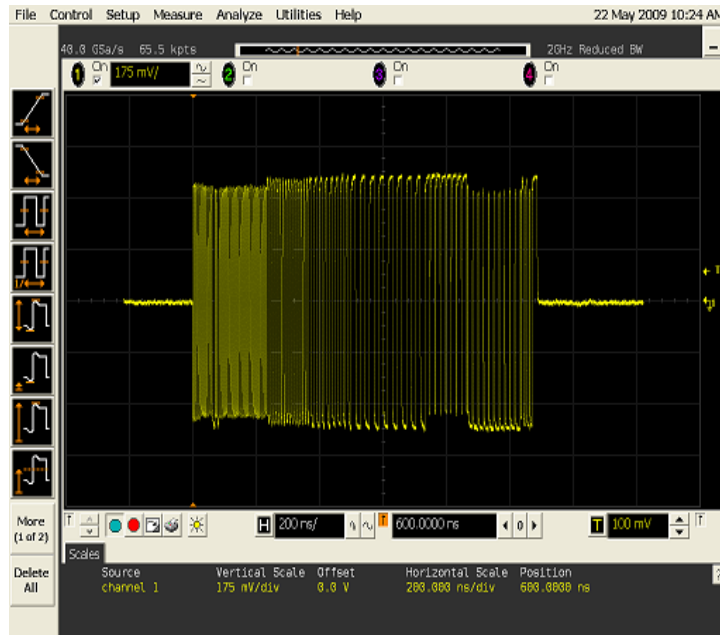

4 Click **OK** to close the Test Instructions dialog.

EL_6 Host Rise Time

EL_6 Host Fall Time

EL_3 Data Eye and Mask Test

After viewing the test results, click **OK** to close the Test Instructions dialog.

EL_7 Host Non-Monotonic Edge Test

Viewing Test Results

When the Testing Complete dialog appears, click **OK**. The Results tab shows the test results.

Host Controller Packet Parameters

Equipment Used

Table 29 Equipment Used in Host Controller Packet Parameters Tests

Quantity	Item	Description/Model
1	Oscilloscope	Keysight S-Series, 9000A, 90000A, MXR, or UXR Series
1	Probe type	Differential active (at least 2.5 GHz bandwidth) with E2678B socketed probe head or active probe (for single-ended connection only)
1	Header adapter (only needed if you are using the old test fixture - E2645-66507)	Keysight 01131-68703
1	Host test bed computer	Any computer with hi-speed USB ports
1	Device Hi-Speed Signal Quality test fixture and 4" USB cable	Keysight E2666B
1	Hi-Speed USB hub	Any listed on USB-IF website

Selecting the Tests

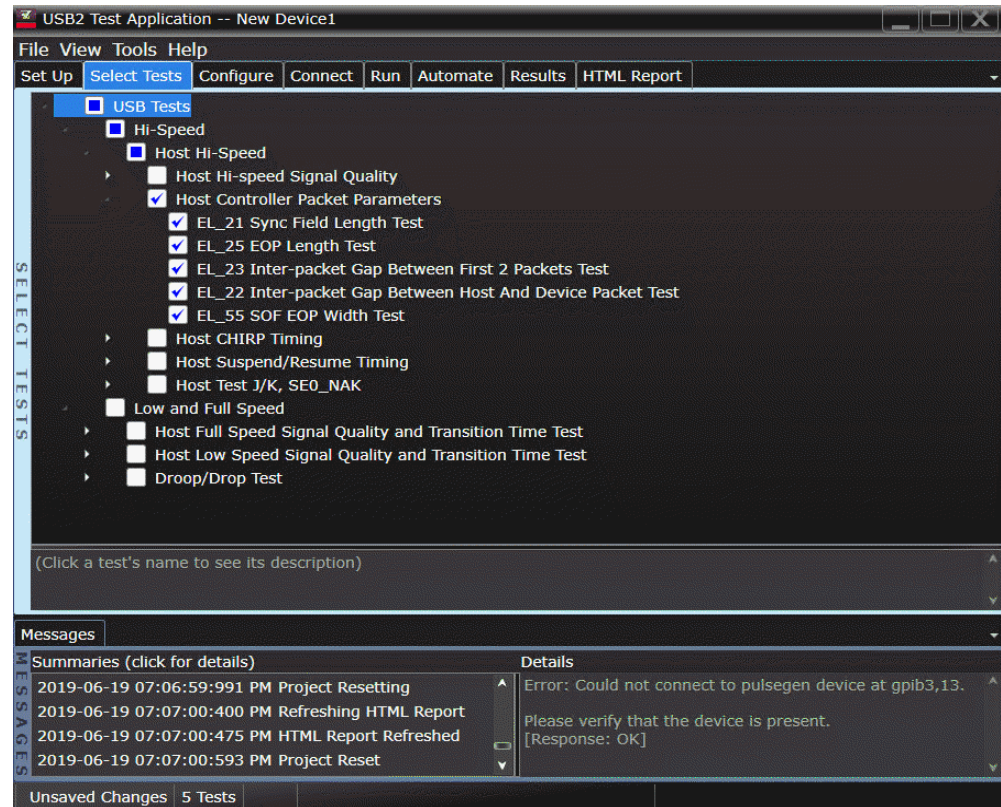

Figure 9 Host packet parameter tests

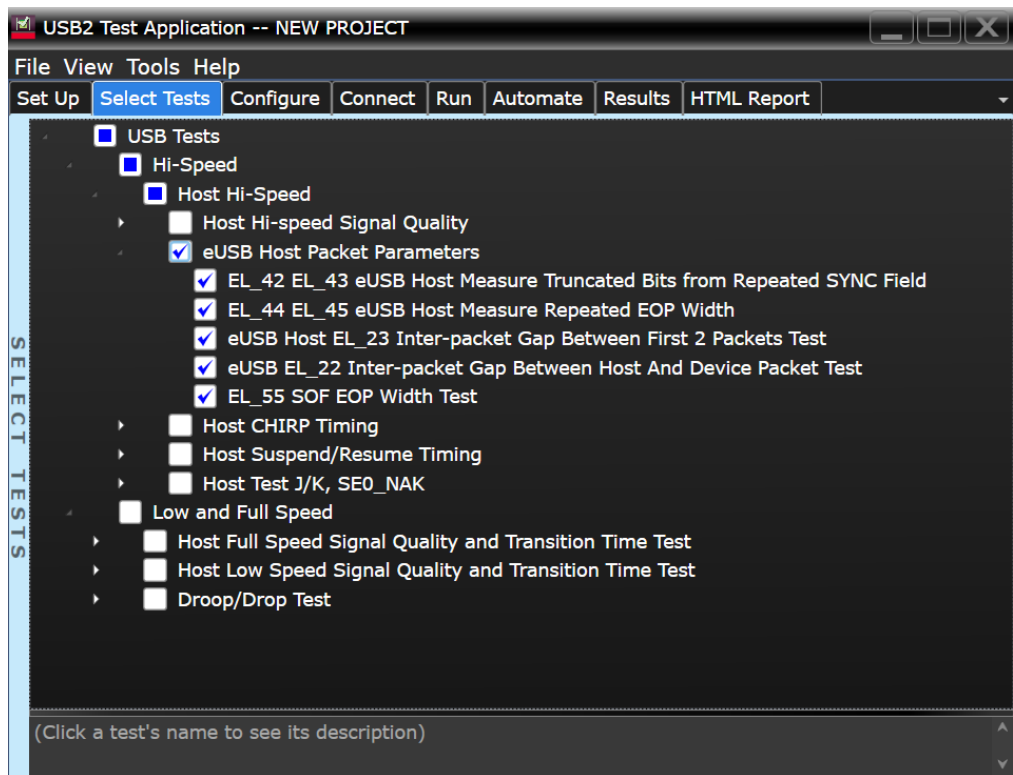

Figure 10 Host packet parameter tests - eUSB option selected

Configuring the Tests

Connecting the Equipment - Differential Connection

The USB automated test application will prompt you to perform these connection steps:

- 1 Connect the High Speed Signal Quality test fixture into the host port under test, using a USB cable.
- 2 Connect the test fixture into a known good device, using the 4" USB cable. Apply power to the device.
- 3 Ensure that the test switch on the test fixture is in the OFF position, and the test LED is not lit.
- 4 Attach a differential probe on Channel 1 to D+ and D- of TP2 of the test fixture, using a compatible header adapter.

NOTE

1. If you are using E2649-26401/E2649-26402/E2649-26403/E2649-26404 you would not need to use the damped header adapter.
2. If you are using differential connection test connections for E2649-26401/E2649-26402 /E2649-26403/E2649-26404, please terminate the SMA connector with 50 Ohm terminators.

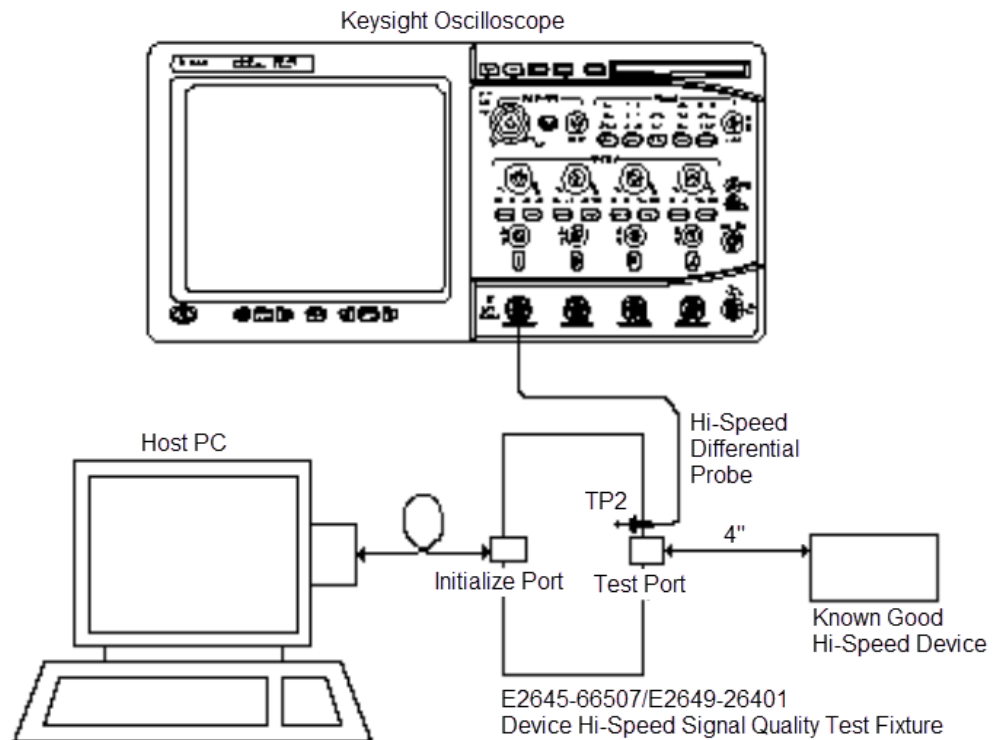

- 5 Check **I have completed these instructions.**

Connecting the Equipment - Single-Ended Connection

The USB automated test application will prompt you to perform these connection steps:

- 1 Connect the High Speed Signal Quality test fixture into the host port under test, using a USB cable.
- 2 Connect the test fixture into a known good device, using the 4" USB cable. Apply power to the device. Ensure that the test switch on the test fixture is in the OFF position, and the test LED is not lit.
- 3 Attach active probes on undefined and undefined to D+ and D- on the test fixture respectively.

NOTE

1. If you are using E2649-26401/E2649-26402/E2649-26403/E2649-26404 you would not need to use the damped header adapter.
2. If you are using differential connection test connections for E2649-26401/E2649-26402 /E2649-26403/E2649-26404, please terminate the SMA connector with 50 Ohm terminators.

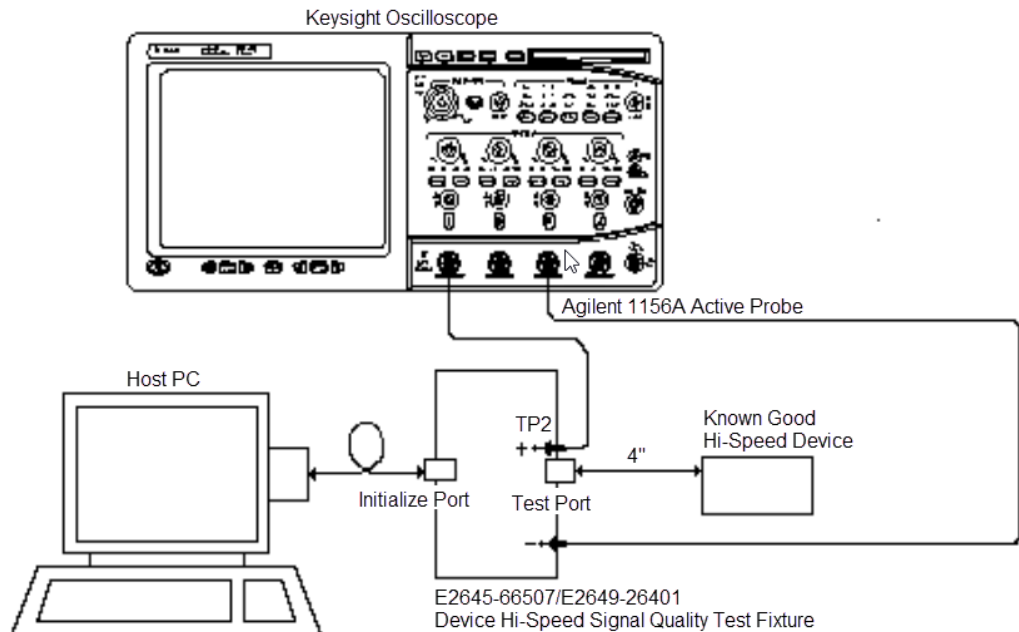

- 4 Check **I have completed these instructions.**

Running the Tests

- 1 Click **Run Tests**.

Test Instructions, Part 1

The USB automated test application will prompt you to perform these steps:

- 1 Click **[Enumerate Bus]** and verify that the device enumerates properly.

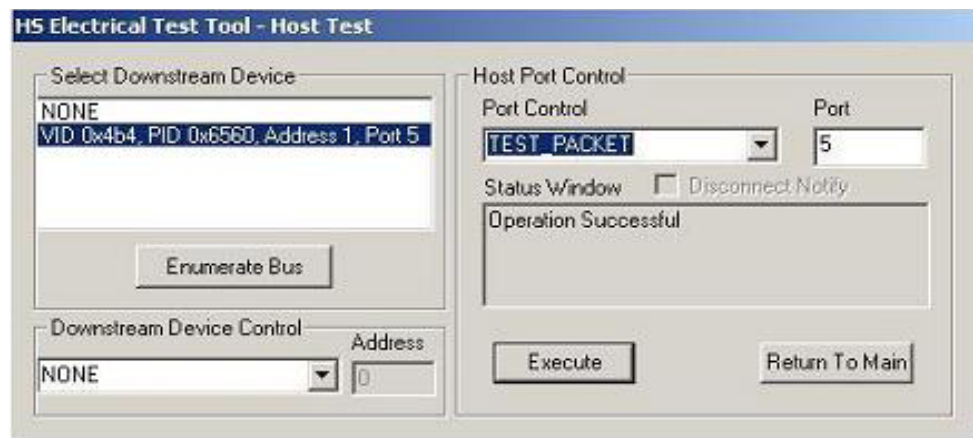

- 2 Using the oscilloscope, verify SOFs (Start of Frame packets) are being transmitted by the port under test. You may need to lower the trigger level to somewhat below 400 mV to obtain a trigger.

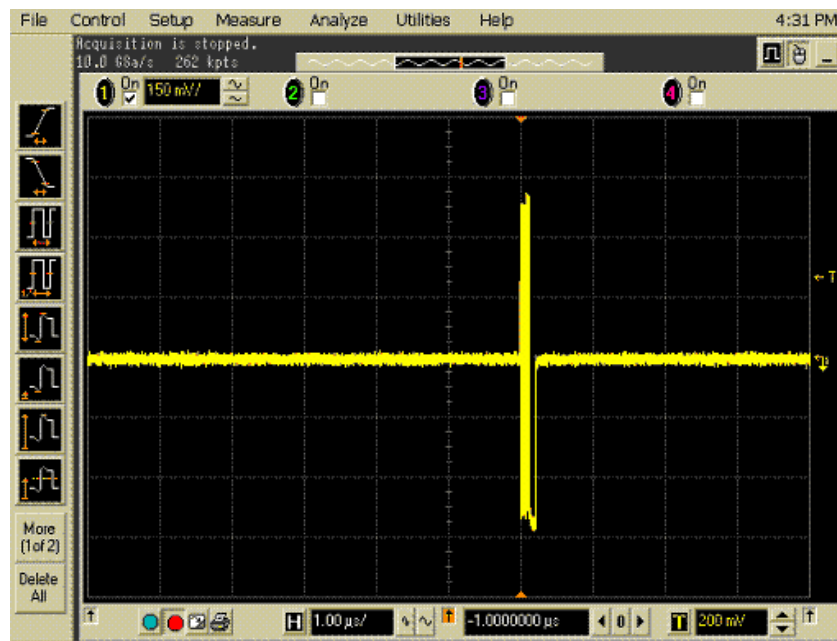

- 3 Click **OK** to close the Test Instructions dialog.

Test Instructions, Part 2

The USB automated test application will prompt you to perform these steps:

- 1 In the Host Test menu of the HS Electrical Test Tool software, ensure that the device is selected.
- 2 Select **SINGLE STEP GET DEV DESC** from the Downstream Device Control menu and click **[EXECUTE]**.

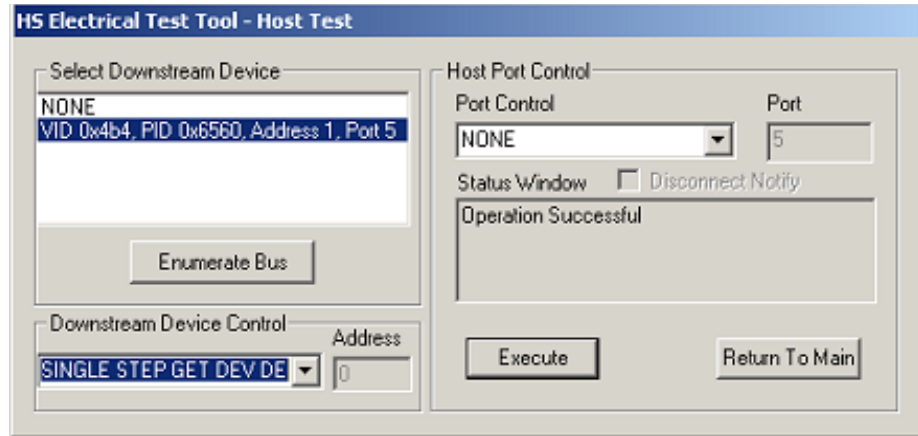

You should see the transmitted test packet on the oscilloscope as below.



- 3 Click **OK** to close the Test Instructions dialog.

EL_21 Sync Field Length Test**EL_25 EOP Length Test****EL_23 Inter-packet Gap Between First 2 Packets Test****EL_22 Inter-packet Gap Between Host and Device Packet Test****Test Instructions, Part 3**

The USB automated test application will prompt you to perform these steps:

- 1 In the Host Test menu of the HS Electrical Test Tool software, click **[STEP]** once again.

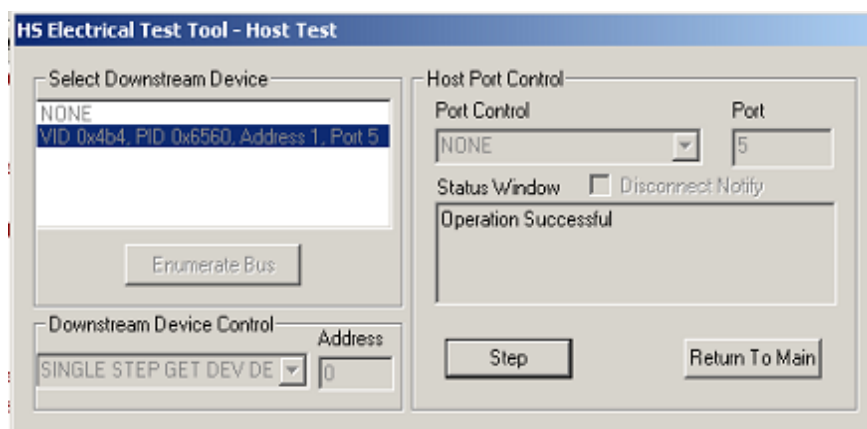

You should see the transmitted test packet on the oscilloscope as below.

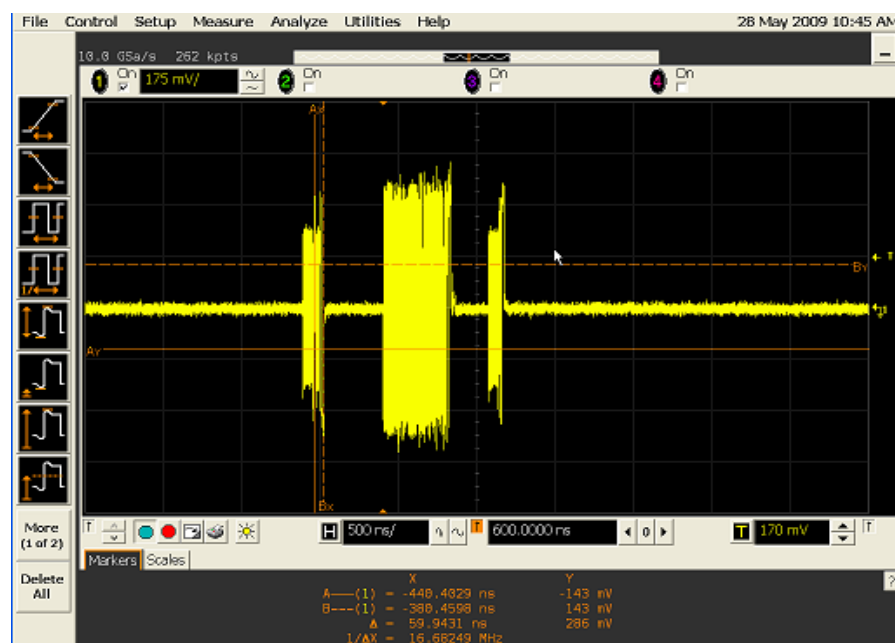

- 2 Click **OK** to close the Test Instructions dialog.

EL_55 SOF EOP Width Test

Test Instructions

The USB automated test application will prompt you to perform these steps:

- 1 Using the oscilloscope, verify SOFs(Start of Frame packets) are being transmitted by the port under test. You may need to lower the trigger level to somewhat below 400 mV to obtain a trigger.

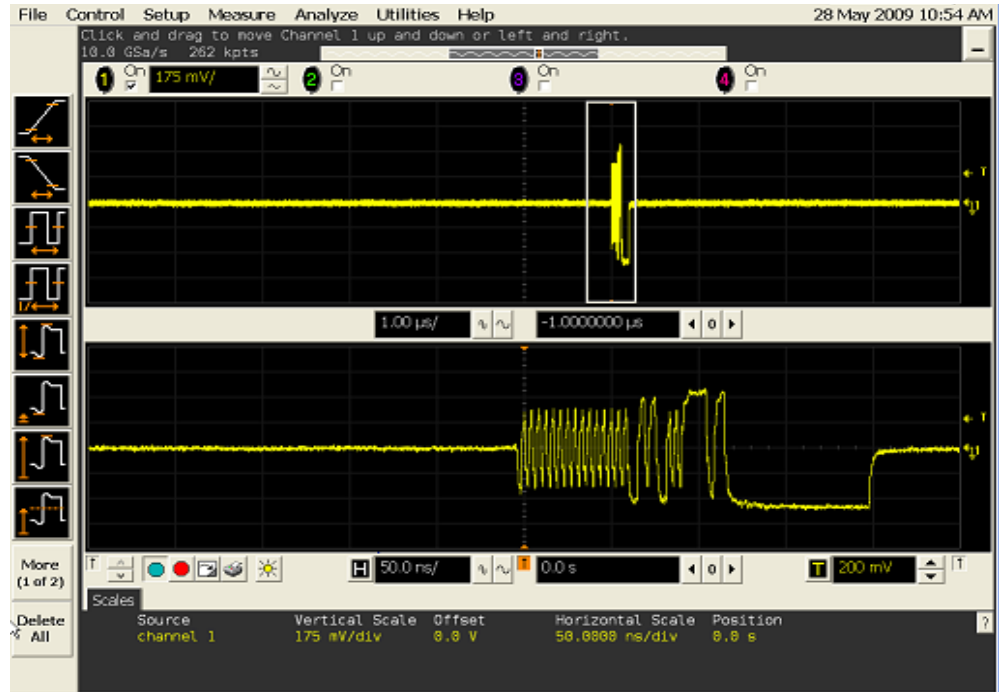

- 2 Click **OK** to close the Test Instructions dialog.

Viewing Test Results

- 1 When the Testing Complete dialog appears, click **OK**.
The Results tab shows the test results.

Host CHIRP Timing

Equipment Used

Table 30 Equipment Used in Host CHIRP Timing Tests

Quantity	Item	Description/Model
1	Oscilloscope	Keysight S-Series, 9000A, 90000A, MXR, or UXR Series
2	Probe type	Passive
1	Host test bed computer	Any computer with hi-speed USB ports
1	Host Hi-Speed Signal Quality test fixture and 4" USB cable	Keysight E2649-66402 (old fixture P/N E2645-66508)
1	Hi-Speed USB device	Any listed on USB-IF web site
1	5 meter USB 2.0 hi-speed cable	Any listed on USB-IF web site

Selecting the Tests

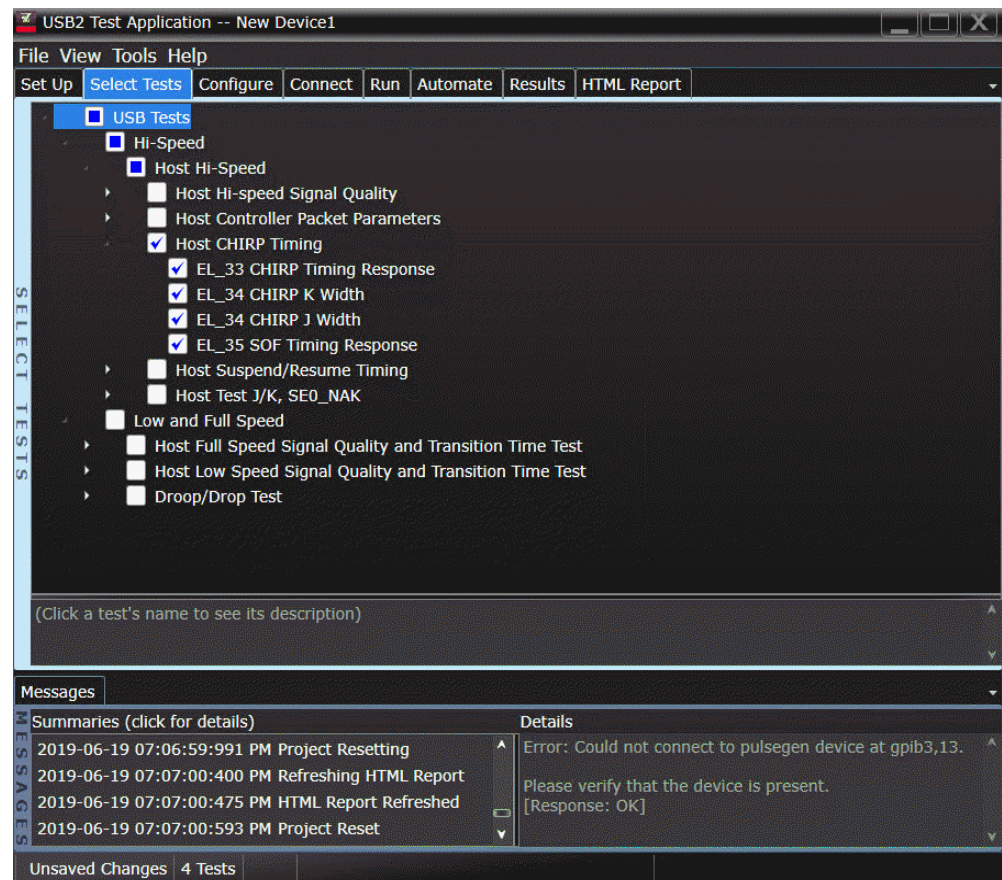

Configuring the Tests

Connecting the Equipment

The USB automated test application will prompt you to perform these connection steps:

- 1 Replace the E2649-26404 (E2645-66506 if you are using the old fixture) Disconnect test fixture with the E2645-26402 (E2645-66508 if you are using the old fixture) Host Hi-Speed Signal Quality test fixture. Do not apply 5V to the test fixture.
- 2 Connect a high impedance adapter with passive probe or an active probe on Channel 2 to the D- pin at TP2.
- 3 Connect a high impedance adapter with passive probe on Channel 3 to the D+ pin at TP2. D+ on TP2 is the pin closest to the USB connector for the E2645-66508 Host Hi-Speed Signal Quality test fixture.
- 4 Connect both probe grounds to leads TP5.
- 5 Connect a known good Hi-Speed device into the [INIT PORT] of the test fixture, using the 5-meter USB cable.
- 6 Connect the [TEST PORT] on the fixture to the port under test, using the 4" USB cable.
- 7 Apply power to the known good Hi-Speed device.

NOTE

1. If you are using E2649-26401/E2649-26402/E2649-26403, please terminate the SMA connector with 50 Ohm terminators.
2. E2697A is not needed for DSO9000 series oscilloscope.

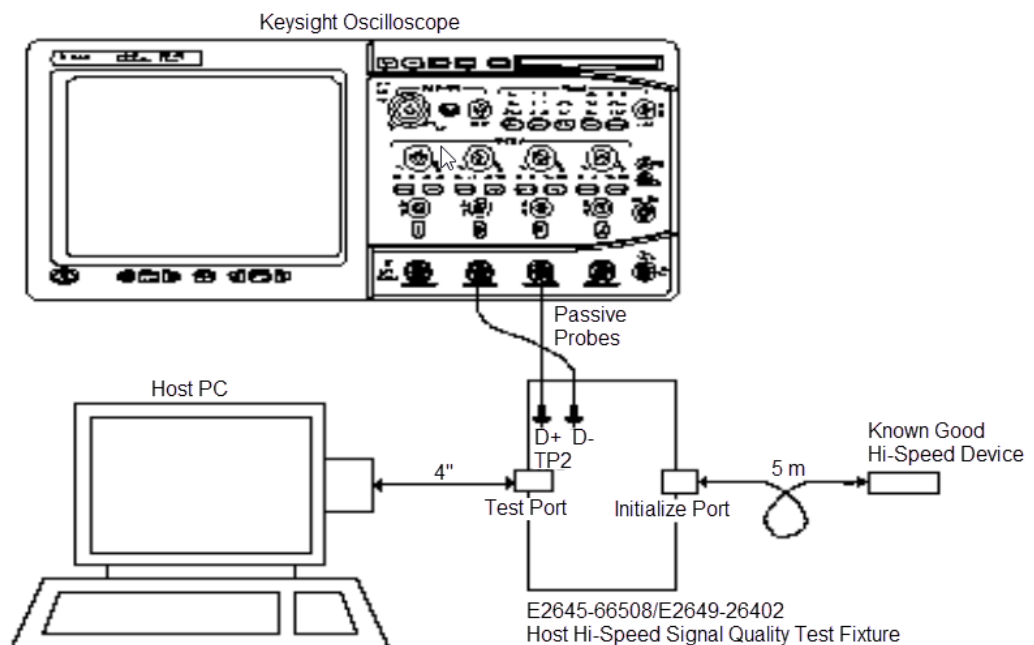

- 8 Check **I have completed these instructions.**

Running the Tests

- 1 Click **Run Tests**.

Test Instructions

The USB automated test application will prompt you to perform these steps:

- 1 On the HS Electrical Test Tool software, click [**Enumerate Bus**] once. You should capture the CHIRP handshake as in the below figure.

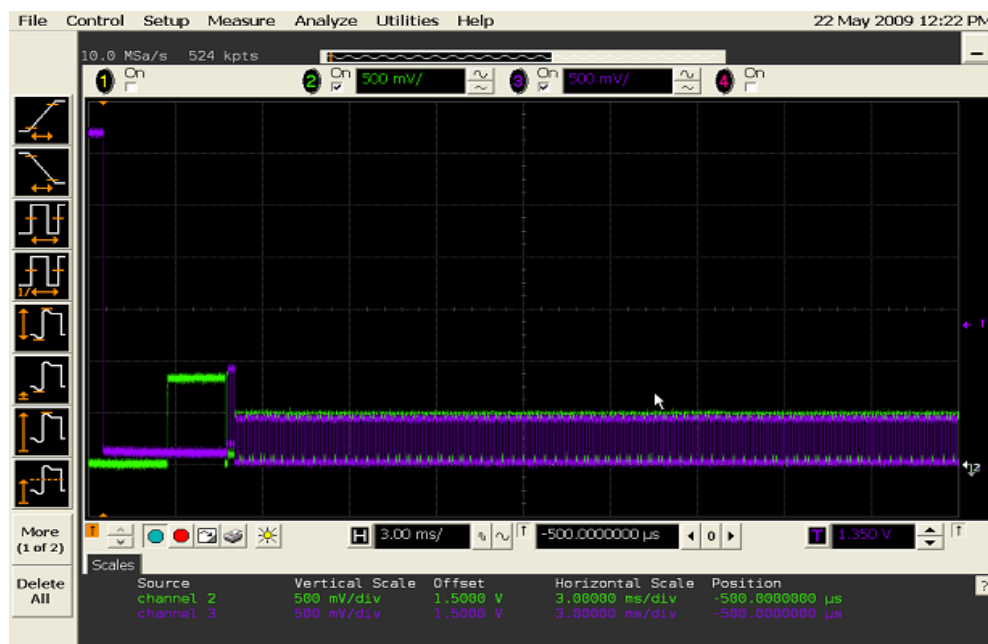

- 2 Click **OK** to close the Test Instructions dialog.

EL_33 CHIRP Timing Response**EL_34 CHIRP K Width****EL_34 CHIRP J Width****EL_35 SOF Timing Response**

The USB automated test application will prompt you to: Unplug the known good device and reattach it.

The USB automated test application will prompt you to perform these steps:

- 1 On the Host Test menu of the HS Electrical Test Tool software, click **[Enumerate Bus]** once. The oscilloscope should capture as in the below figure.

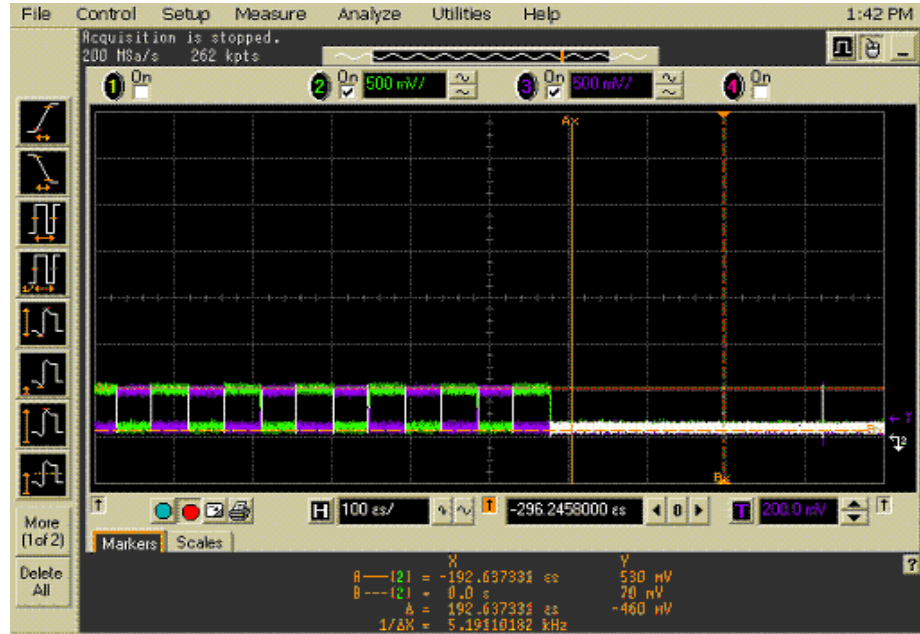

- 2 Click **OK** to close the Test Instructions dialog.

Viewing Test Results

- 1 When the Testing Complete dialog appears, click **OK**.
The Results tab shows the test results.

Host Suspend/Resume Timing

Equipment Used

Table 31 Equipment Used in Host Suspend/Resume Timing Tests

Quantity	Item	Description/Model
1	Oscilloscope	Keysight S-Series, 9000A, 90000A, MXR, or UXR Series
2	Probe type	Passive
1	Host test bed computer	Any computer with hi-speed USB ports
1	Host Hi-Speed Signal Quality test fixture and 4" USB cable	Keysight E2649-66402 (old fixture P/N E2645-66508)
1	Hi-Speed USB device	Any listed on USB-IF web site
1	5 meter USB 2.0 hi-speed cable	Any listed on USB-IF web site

Selecting the Tests

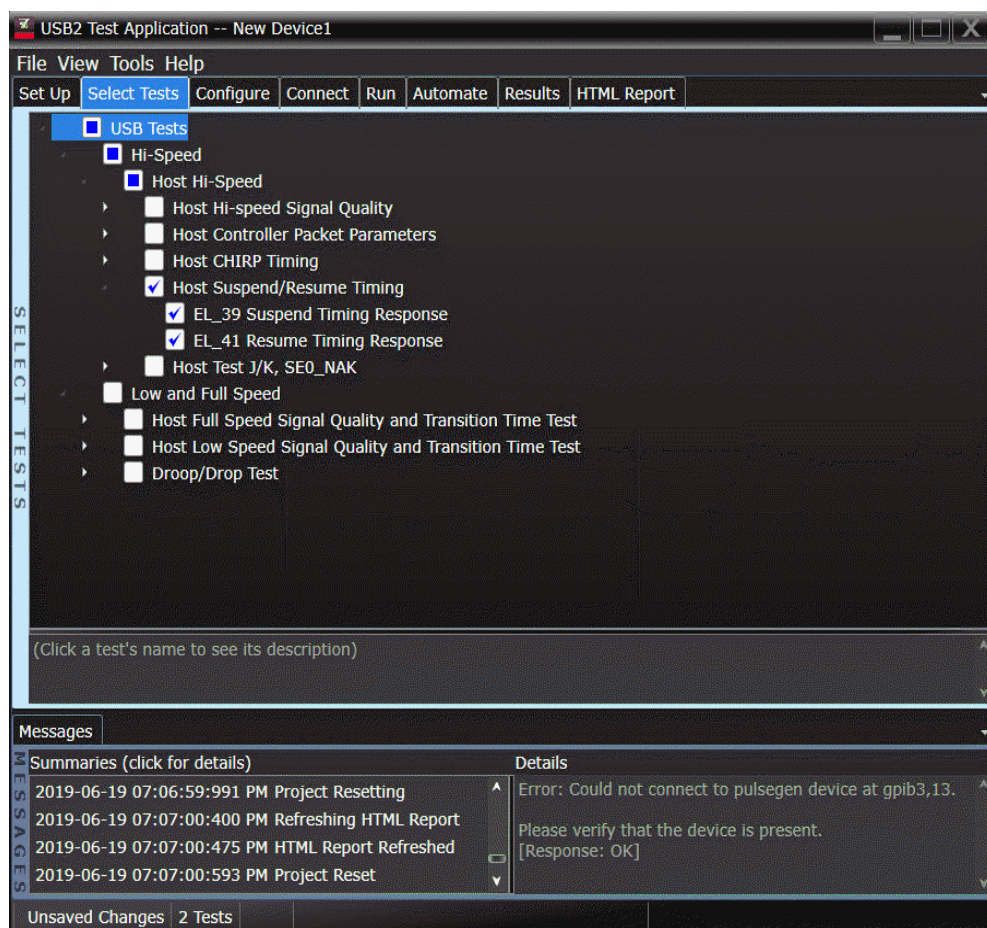

Configuring the Tests

Connecting the Equipment

The USB automated test application will prompt you to perform these connection steps:

- 1 Replace the E2649-26404 (E2645-66506 if you are using the old fixture) Disconnect test fixture with the E2645-26402 (E2645-66508 if you are using the old fixture) Host Hi-Speed Signal Quality test fixture. Do not apply 5V to the test fixture.
- 2 Connect a high impedance adapter with passive probe on Channel 2 to the D- pin at TP2.
- 3 Connect a high impedance adapter with passive probe or the an active probe on Channel 3 to the D+ pin at TP2. D+ on TP2 is the pin closest to the USB connector for the E2645-66508 Host Hi-Speed Signal Quality test fixture.
- 4 Connect both probe grounds to leads TP5.
- 5 Connect a known good Hi-Speed device into the [INIT PORT] of the test fixture, using the 5-meter USB cable.
- 6 Connect the [TEST PORT] on the fixture to the port under test, using the 4" USB cable.
- 7 Apply power to the known good Hi-Speed device.

NOTE

1. If you are using E2649-26401/E2649-26402/E2649-26403, please terminate the SMA connector with 50 Ohm terminators.
2. E2697A is not needed for DS09000 series oscilloscope.

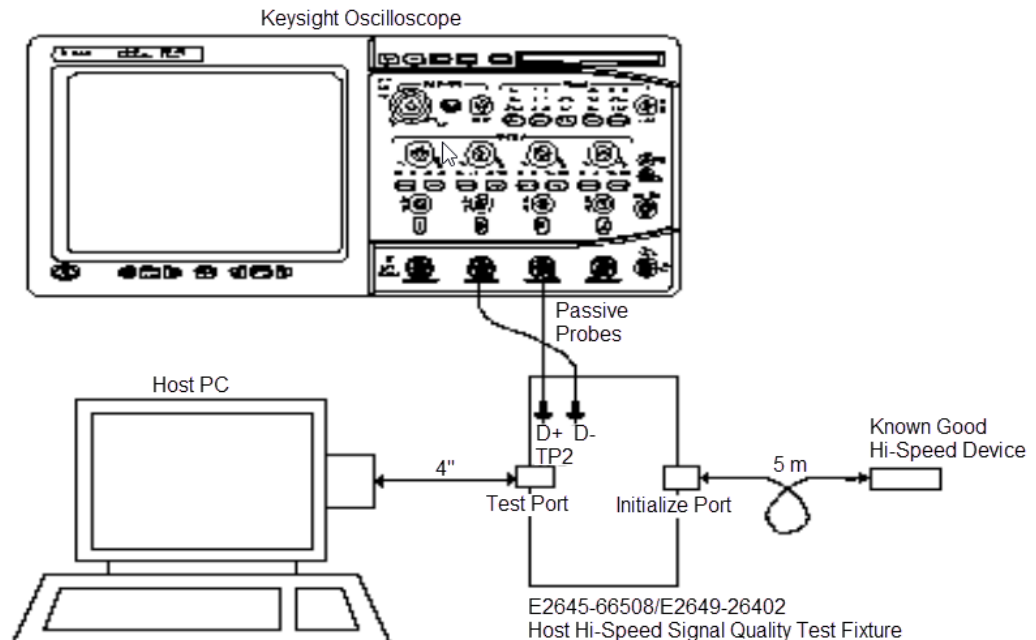

- 8 Check **I have completed these instructions.**

Running the Tests

- 1 Click **Run Tests**.

Test Instructions

EL_39 Suspend Timing Response

The USB automated test application will prompt you to perform these steps:

- 1 On the Host Test menu of the HS Electrical Test Tool software, click [**Enumerate Bus**] once.
- 2 Select **SUSPEND** from the Port Control drop down menu.
- 3 Enter the port number. Click [**EXECUTE**] once to place the port into suspend. The captured transition should be as in the figure below.

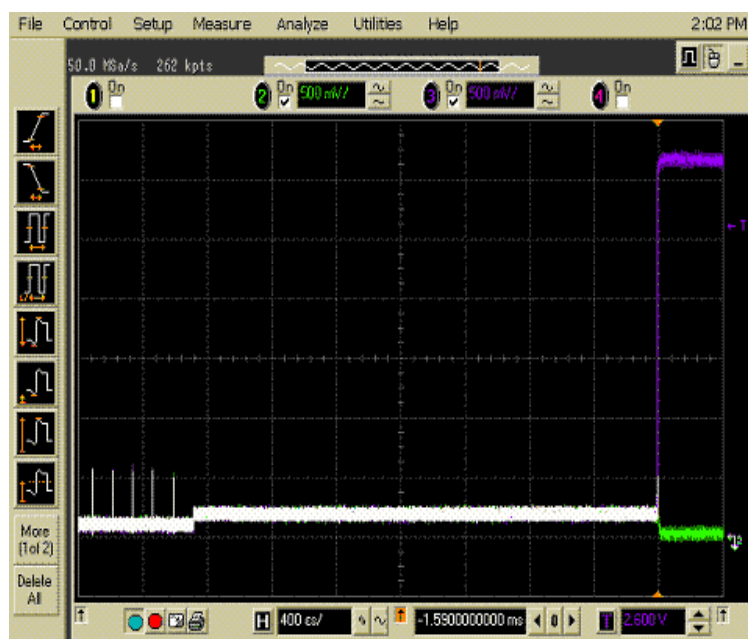
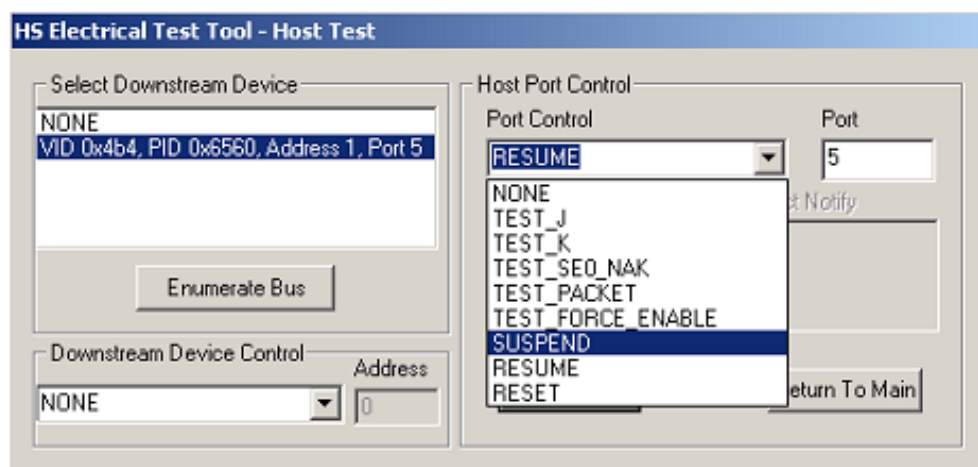

- 4 Click **OK** to close the Test Instructions dialog.

EL_41 Resume Timing Response

The USB automated test application will prompt you to perform these steps:

- 1 On the Host Test menu of the HS Electrical Test Tool software, select **RESUME** from the Port Control drop down menu.
- 2 Enter the port number. Click **[EXECUTE]** once to resume the port.

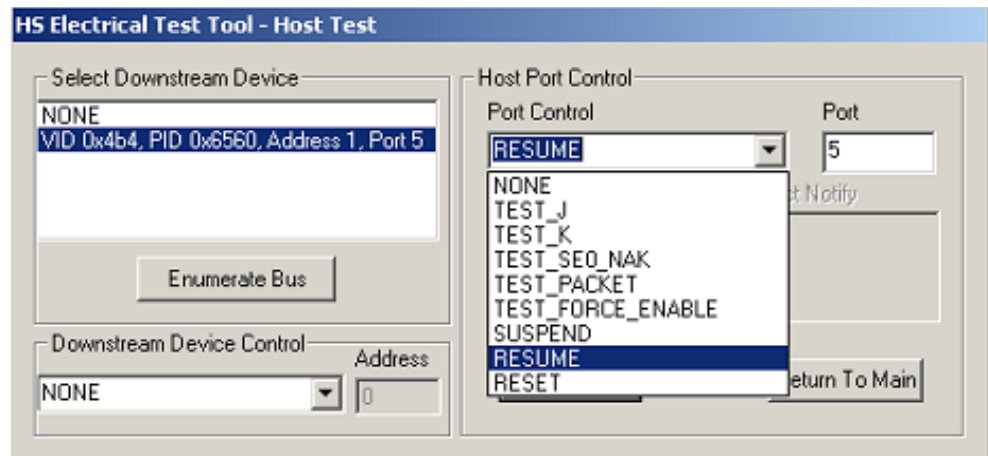

The captured transition should be as in the figure below.

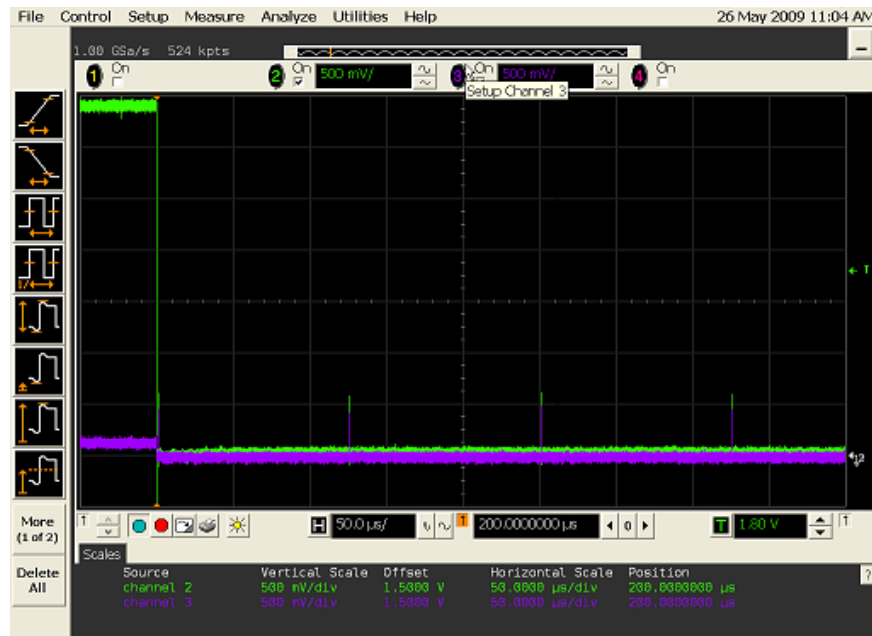

- 3 Click **OK** to close the Test Instructions dialog.

Viewing Test Results

- 1 When the Testing Complete dialog appears, click **OK**.
The Results tab shows the test results.

Host Test J/K, SEO_NAK

Equipment Used

Table 32 Equipment Used in Host Test J/K, SEO_NAK Tests

Quantity	Item	Description/Model
1	Digital Multimeter (DMM)	Keysight 34461A or equivalent
1	Host test bed computer	Any computer with hi-speed USB ports
1	Host Hi-Speed Signal Quality test fixture and 4" USB cable	Keysight E2649-66402 (old fixture P/N E2645-66508)
1	5V power supply	Keysight 8121-1966 or equivalent

Selecting the Tests

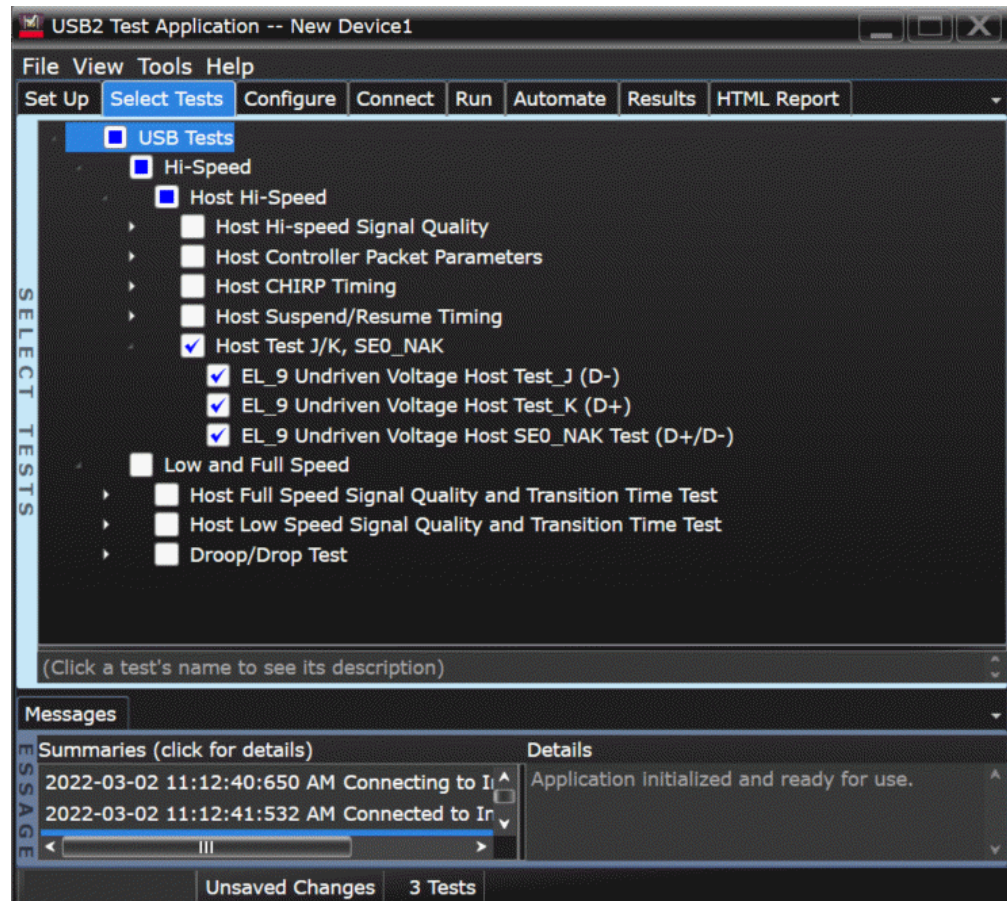

Configuring the Tests

Connecting the Equipment (Using Probes)

The USB automated test application will prompt you to perform these connection steps:

- 1 Attach the 5V power supply to J5 of the E2649-26402 (E2645-66508 if you are using the old test fixture) Host High-Speed Signal Quality test fixture. Verify the green Power LED(D1) is lit
- 2 Connect the [TEST PORT] of the test fixture into the port of host under test, using the 4" USB cable.
- 3 Connect channel 1 to D+ and Channel 3 to D- using [SMA Cable].
- 4 Connect known good device to [INIT PORT].

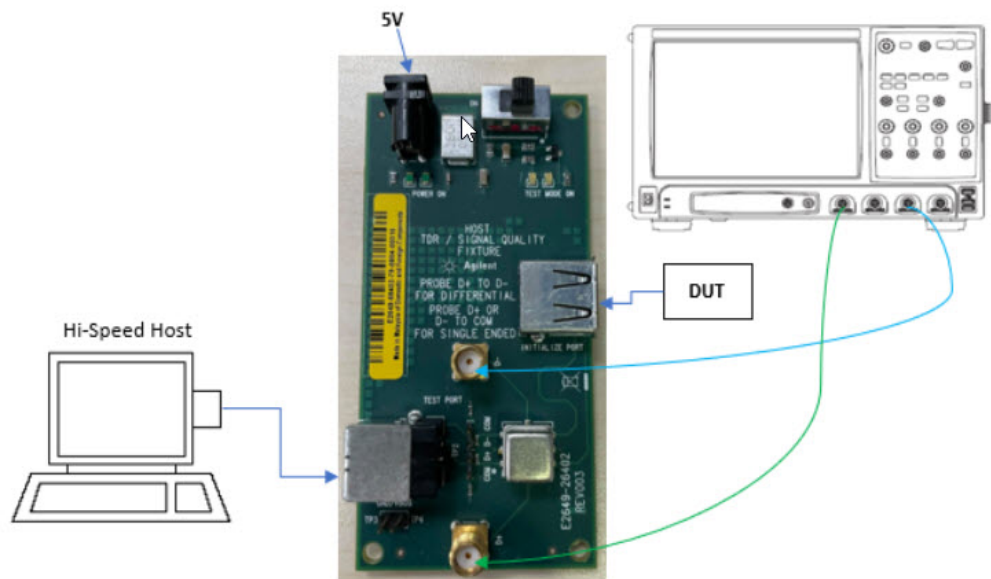

- 5 Check I have completed these instructions.

Connecting the Equipment (Using Voltmeter)

The USB automated test application will prompt you to perform these connection steps:

- 1 Attach the 5V power supply to J5 of the E2649-26402 (E2645-66508 if you are using the old test fixture) Host High-Speed Signal Quality test fixture. Verify the green Power LED(D1) is lit.
- 2 Connect the [TEST PORT] of the test fixture into the port of under test.
- 3 Using a [Voltmeter] for voltage measurement.
- 4 Connect known good device to [INIT PORT]

NOTE

If you are using E2649-26401/E2649-26402/E2649-26403, please terminate the SMA connector with 50 Ohm terminators.

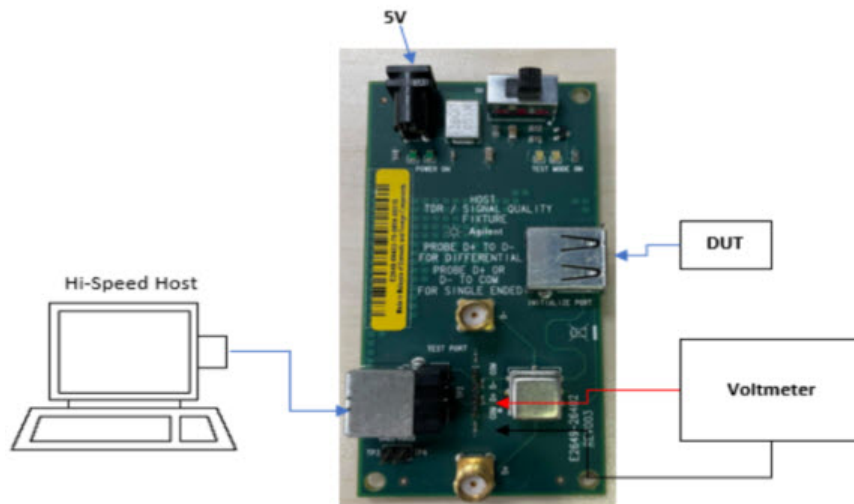

- 5 Check **I have completed these instructions.**

Running the Tests

- 1 Click **Run Tests**.

Test Instructions

EL_9 Undriven Voltage Host Test_J (D-) Test

The USB automated test application will prompt you to perform these steps:

- 1 On the Host Test menu of the HS Electrical Test Tool software, select **TEST_J** from the Port Control drop down menu.
- 2 Enter the port number. Click **[EXECUTE]** once to place the port under test into the TEST_J test mode.

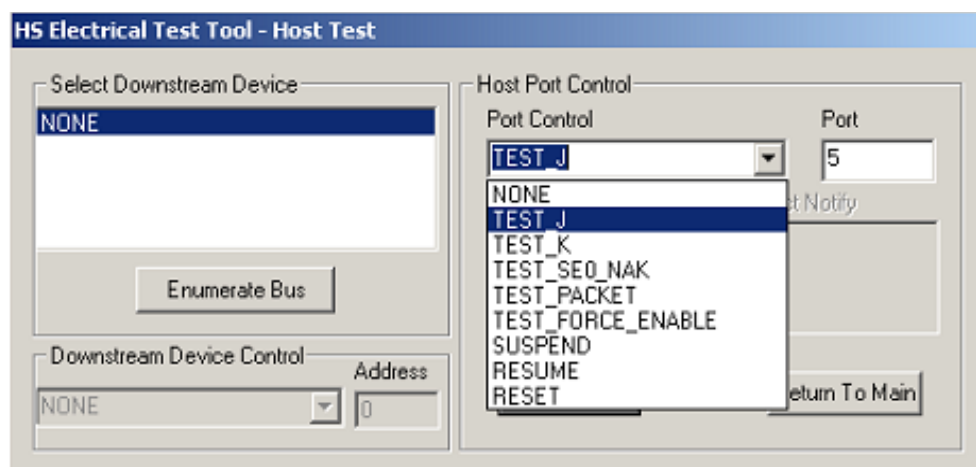

- 3 Click **OK** to close the Test Instructions dialog.

The USB automated test application will prompt you for the following voltage measurements:

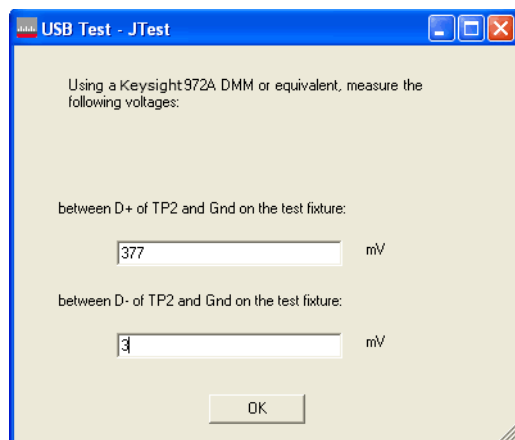

EL_9 Undriven Voltage Host Test_K (D+) Test

The USB automated test application will prompt you to perform these steps:

- 1 On the Host Test menu of the HS Electrical Test Tool software, select **TEST_K** from the Port Control drop down menu.
- 2 Enter the port number. Click **[EXECUTE]** once to place the port under test into the TEST_K test mode.

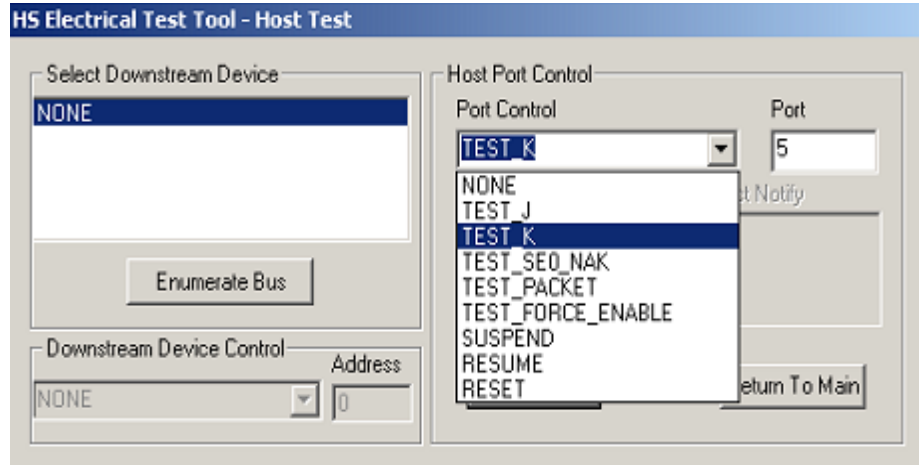

- 3 Click **OK** to close the Test Instructions dialog.

The USB automated test application will prompt you for the following voltage measurements:

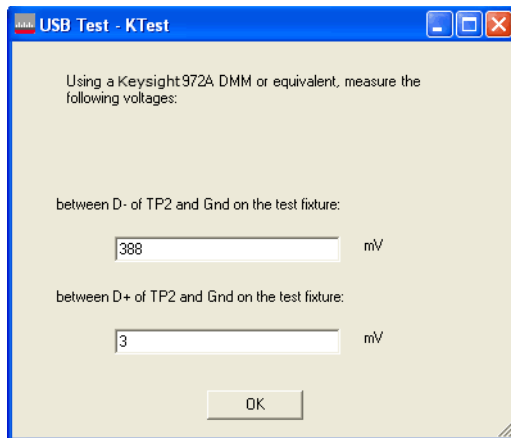

EL_9 Undriven Voltage Host SEO_NAK Test (D+/D-) Test

The USB automated test application will prompt you to perform these steps:

- 1 On the Host Test menu of the HS Electrical Test Tool software, select **TEST_SEO_NAK** from the Port Control drop down menu.
- 2 Enter the port number. Click **[EXECUTE]** once to place the port under test into the TEST_SEO_NAK test mode.

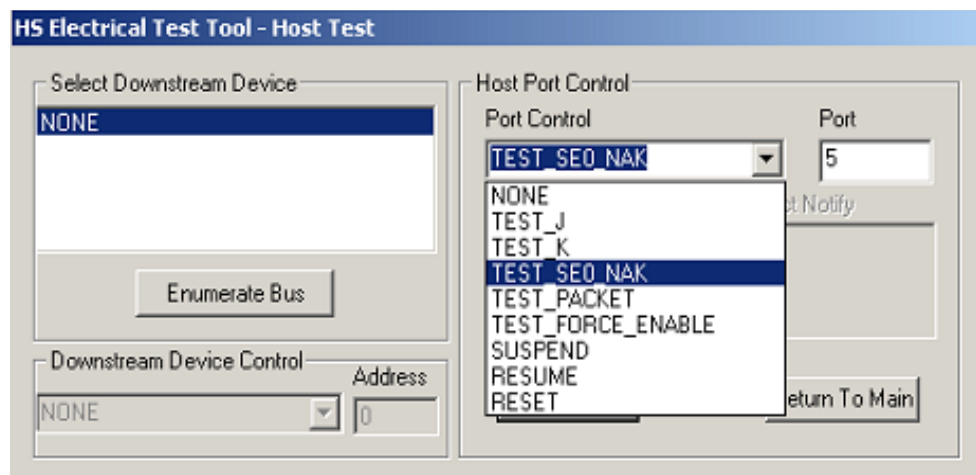

3 Click **OK** to close the Test Instructions dialog.

The USB automated test application will prompt you for the following voltage measurements:

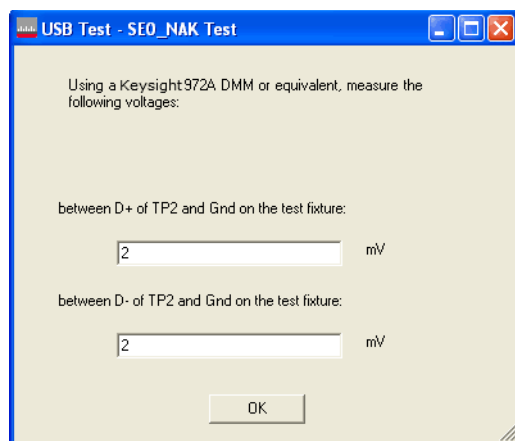

Viewing Test Results

- 1 When the Testing Complete dialog appears, click **OK**.
The Results tab shows the test results.

6 Troubleshooting Hi-Speed Test Failures

In the Configure tab's Debug Mode, there are several options that can help you troubleshoot hi-speed test failures:

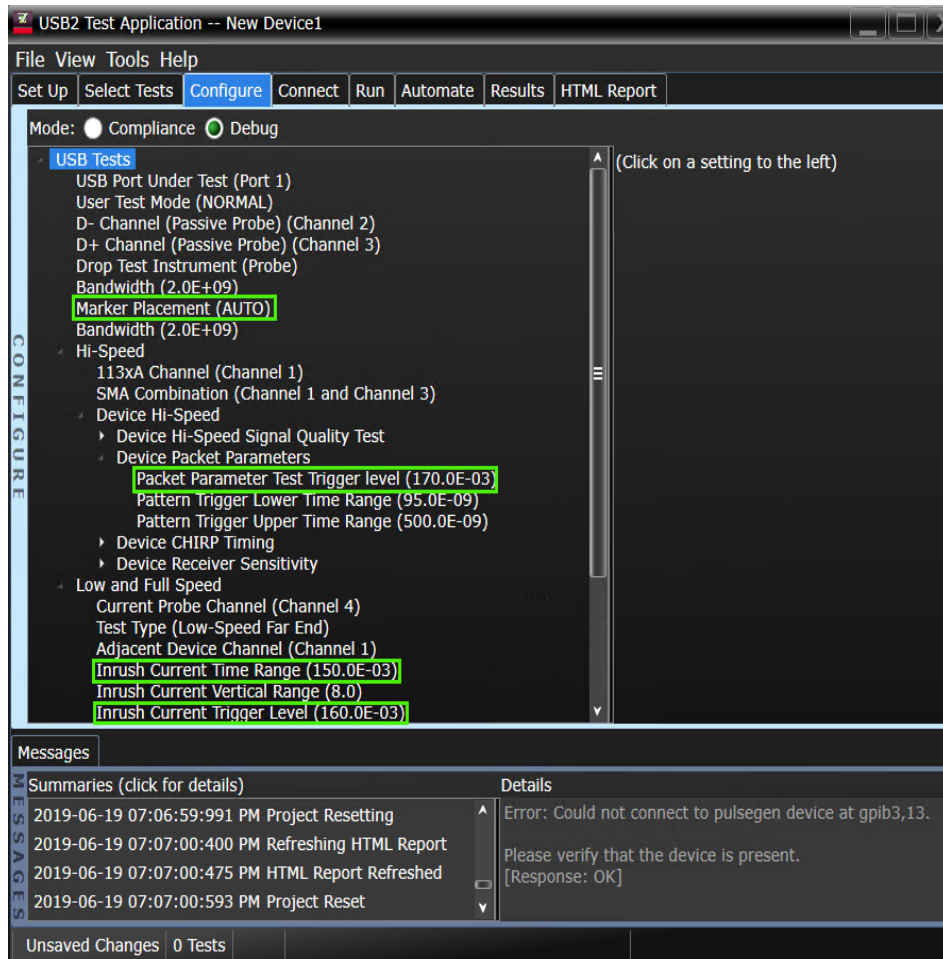

Figure 11 Debug Mode Options for Hi-Speed Testing

- Marker Placement – Lets you manually adjust the markers around the required packet/pattern before proceeding with the test analysis. When "MANUAL" is selected, the automated search for the correct pattern/packet to analyze is turned off.

- Packet Parameter Test Trigger level – Allows you to select or enter the voltage level to use when triggering on the inter-packet gaps. Noisy signals may have low amplitudes; therefore, the trigger level should be reduced.
- Inrush Current Time Range – Allows you to select the total time range to capture inrush current.
- Inrush Current Trigger Level – Allows you to select the trigger level to use to capture inrush current. Self-powered devices may draw very little current, so the trigger level should be reduced.
- The EZJIT analysis software option is also useful for debugging.

7

Low and Full Speed Tests

- Droop/Drop Test 184
- Inrush Current Test 187
- Signal Integrity Test 191
- Back-Voltage Test Before Enumerate 213
- Back-Voltage Test After Enumerate 216

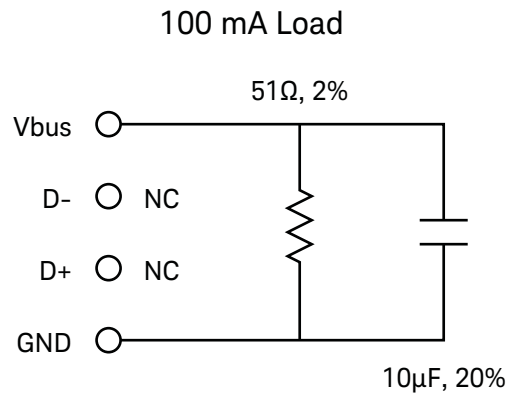

Figure 12 100 mA Load Board Schematic

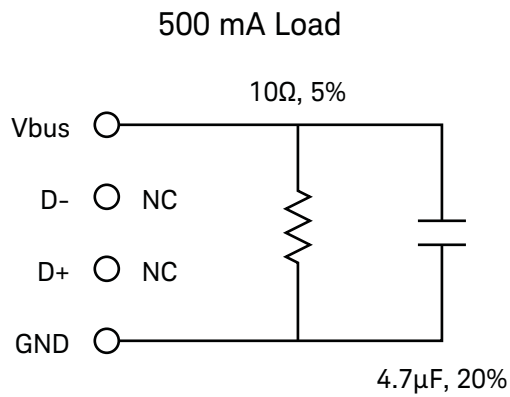

Figure 13 500 mA Load Board Schematic

Droop/Drop Test

The drop test is a measure of a hub's ability to host full load current while keeping the output voltage above spec.

The droop test is a transient test on adjacent ports. When a device is hot plugged into another port, the droop in V_{BUS} supplied to a port must be less than or equal to 220 mV for host, self powered, and bus powered hubs.

NOTE

Keysight Droop Drop Fixture is obsolete and will not be supported by the test application. However, the USB-IF Droop Drop Fixture is supported.

Equipment Used

Table 33 Equipment Used in Droop/Drop Tests

Item	Description/Model	Quantity
Oscilloscope	Keysight S-Series, 9000A, 90000A, MXR, or UXR Series	1
Probe type	Passive probe	2
Digital Multimeter (DMM)	Keysight 34461A or equivalent	1
Droop/Drop test fixture	USB-IF Droop Drop Fixture	1
1 meter USB cable	Any listed on USB-IF web site	1

Selecting the Tests

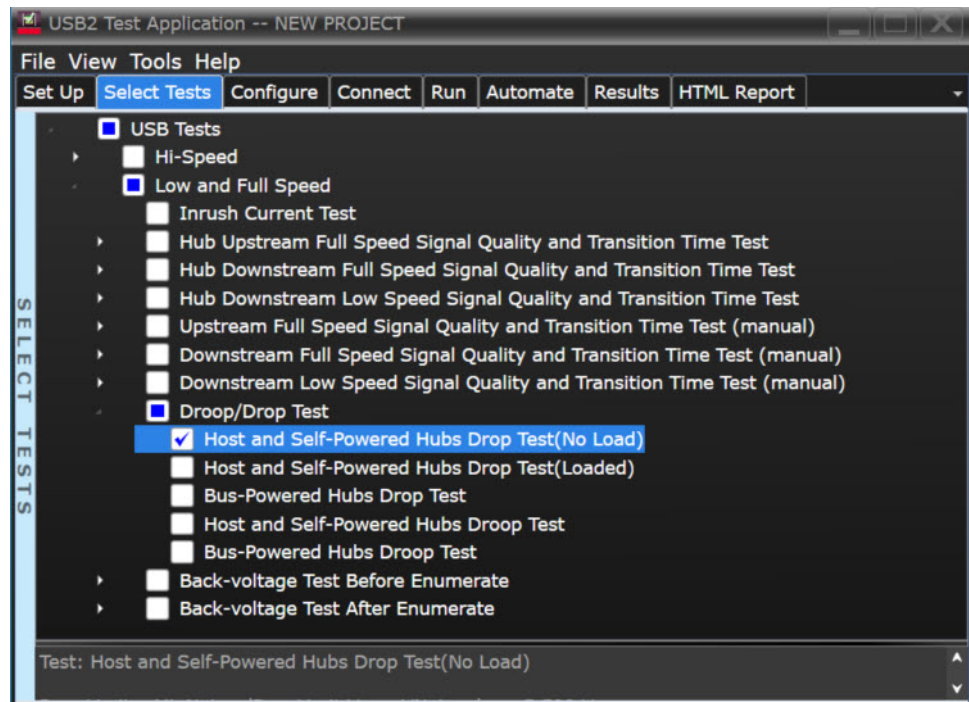

Configuring the Tests

- 1 Click the **Droop Drop Ports** button, and select the test ports you want to use on the fixture. Select either **Hub** or **Host** as the **Device Under Test**.

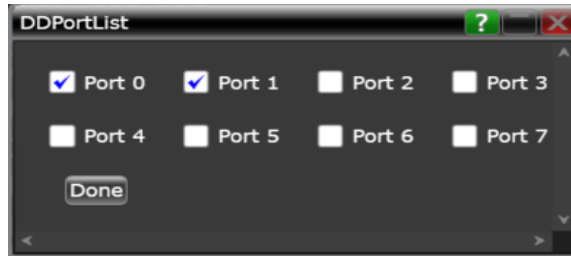

- 2 Make the test connections as displayed in the **Connect** tab.
- 3 Click the **Configure** tab and scroll to the bottom of the left pane. There will be several listings under the **Droop/Drop Test** entry that allow you to configure your tests. Set these to the appropriate values for your specific testing conditions.

Running the Tests

- 1 Click **Run Tests**.

Viewing Test Results

When the test run is complete. The **Results** tab shows the test results.

Selecting the Tests

NOTE

To do manual testing, choose **Both** for the **Test Method** option under the **Set Up** tab. There will then be several manual tests to choose from under the **Select Test** tab.

Inrush Current Test

Equipment Used

Table 34 Equipment Used in Inrush Current Test

Quantity	Item	Description/Model
1	Oscilloscope	Keysight 9000A Series, 90000A Series, or S-Series
1	Probe type	DC coupled current probe with at least 50 MHz bandwidth
1	Digital Multimeter (DMM)	Keysight 34401A, 34461A, or equivalent
1	SQiDD board	Keysight E2646B
1	USB self-powered hub	Any listed on USB-IF web site
1	1 meter USB cable	Any listed on USB-IF web site

Selecting the Tests

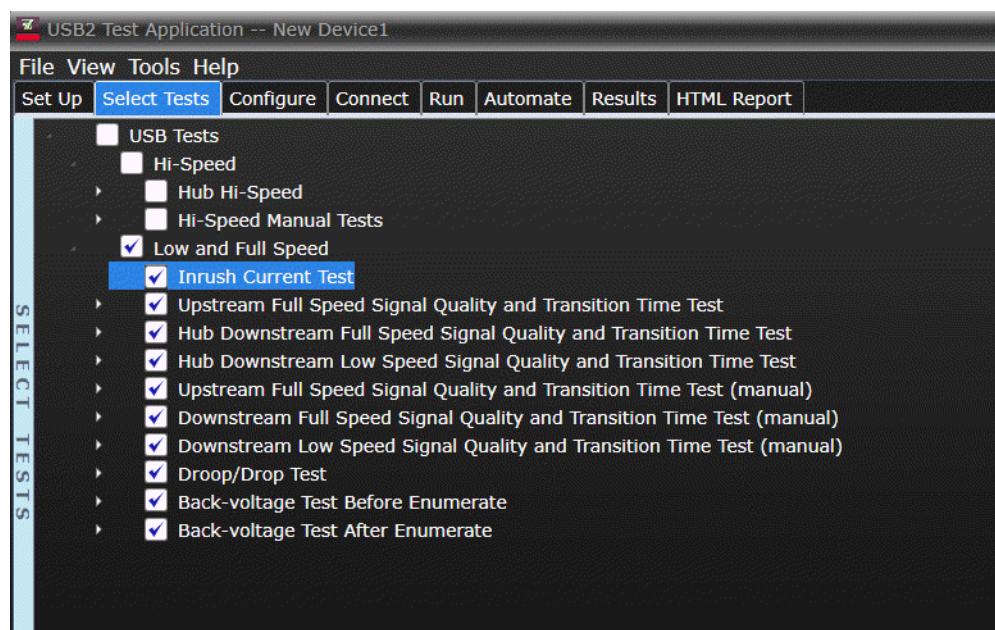

Configuring the Tests

Connecting the Equipment

The USB automated test application will prompt you to perform these connection steps:

- 1 Attach the current probe:
 - a Attach a current probe to the Channel 4 input.
 - b Attach the current probe to the compatible high impedance adapter.
 - c Attach compatible power supply to the current probe.
 - d On the Infiniium Oscilloscope, please navigate to **Setup > Channel 4 > Probes > Configure Probing System command**, and select "Connect 0.1V/A current Probe".
- 2 Zero the current probe.

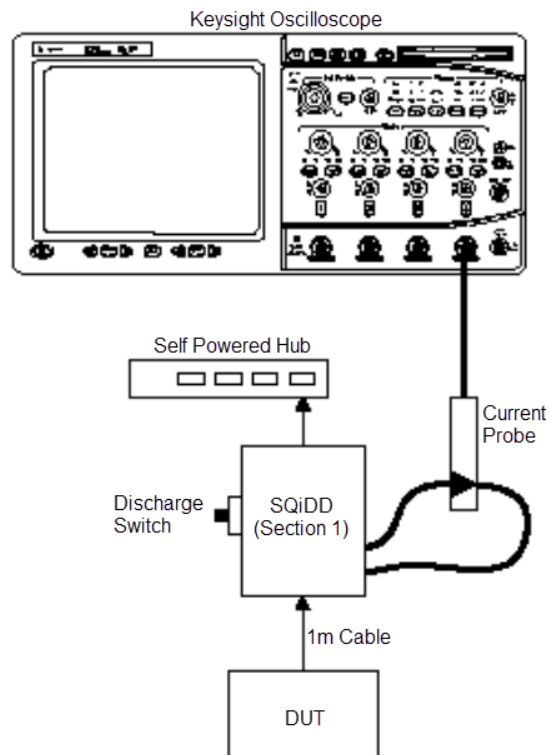

- 3 Check **I have completed these instructions**.

Running the Tests

- 1 Click **Run Tests**.

Test Instructions, Part 1

The USB automated test application will prompt you to perform these steps:

- 1 Attach the current probe to the current loop on the SQiDD board with the arrow on the probe toward the device under test.
- 2 Attach the device under test to the SQiDD board.
- 3 Place the switch on the SQiDD board to the discharge position (opposite the ON position) .
- 4 Disconnect the device under test from the SQiDD board.
- 5 Place the switch on the SQiDD board to the ON position.
- 6 Click **OK** to close the Test Instructions dialog.

Test Instructions, Part 2

The USB automated test application will prompt you to perform these steps:

- 1 Re-connect the device under test to the SQiDD board in order to capture the inrush current waveform.
- 2 Click **OK** to close the Test Instructions dialog box.

Viewing Test Results

When the Testing Complete dialog appears, click **OK**. The Results tab shows the test results.

Signal Integrity Test

Host Low Speed Signal Quality Test

Equipment Used

Table 35 Equipment Used in Host Low Speed Signal Quality Test

Quantity	Item	Description/Model
1	Oscilloscope	Keysight S-Series, 90000A Series, or 9000A Series
2	Probe type	Passive or active probe
1	Host test bed computer	Any computer with hi-speed USB ports
1	SQiDD board	Keysight E2646B
1	low speed USB device	Logitech mouse, P/N 830311-1000, Model #: M-BB48

Selecting the Tests

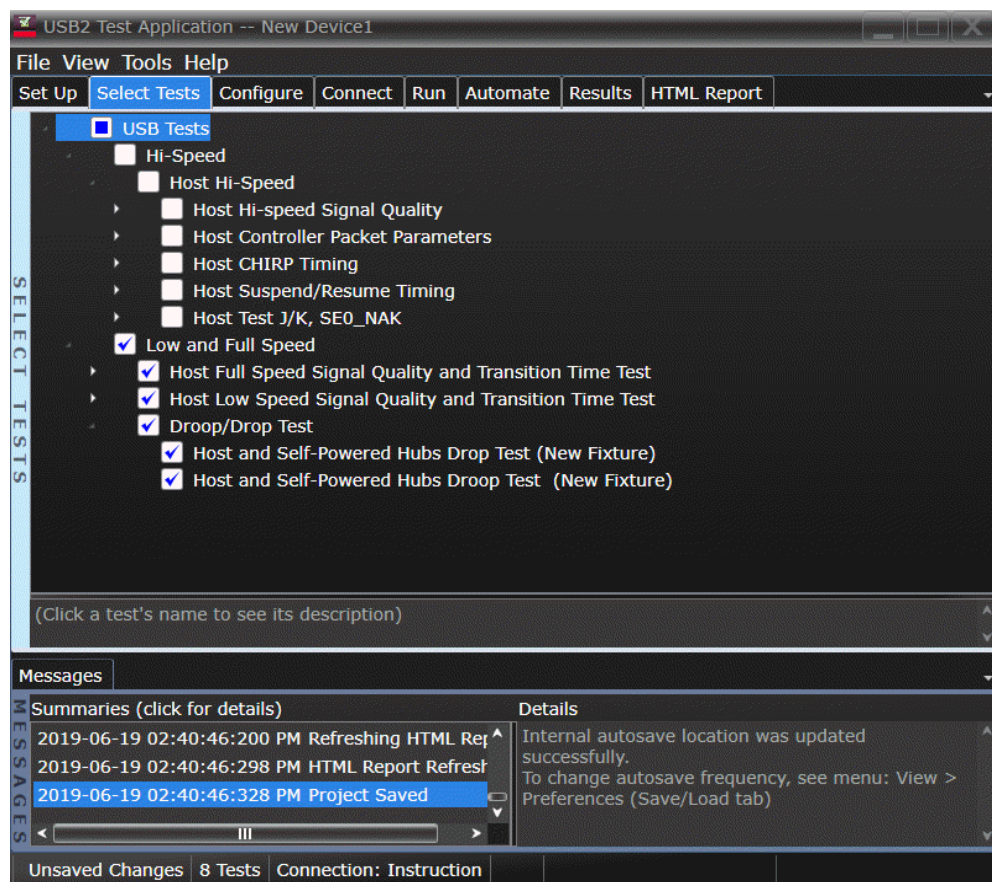

Configuring the Tests

Connecting the Equipment

The USB automated test application will prompt you to perform these connection steps:

- 1 Use high-impedance converter with 10:1 passive probes or you may use active probes.
- 2 Attach the passive probes to the oscilloscope's Channel 3 and Channel 2 inputs.
- 3 Attach the SQiDD board to the root hub on the host under test.
- 4 Attach a low speed device to the same section of the SQiDD board. If the section has a switch, it should be set to ON.
- 5 Connect the oscilloscope Channel 2 probe to D- probe point on the SQiDD board. Connect the oscilloscope Channel 3 probe to the D+ probe point on the SQiDD board.
- 6 Exit the HS Electrical Test Tool if you have previously launched it.

NOTE

E2697A is not needed for DS09000 series oscilloscope.

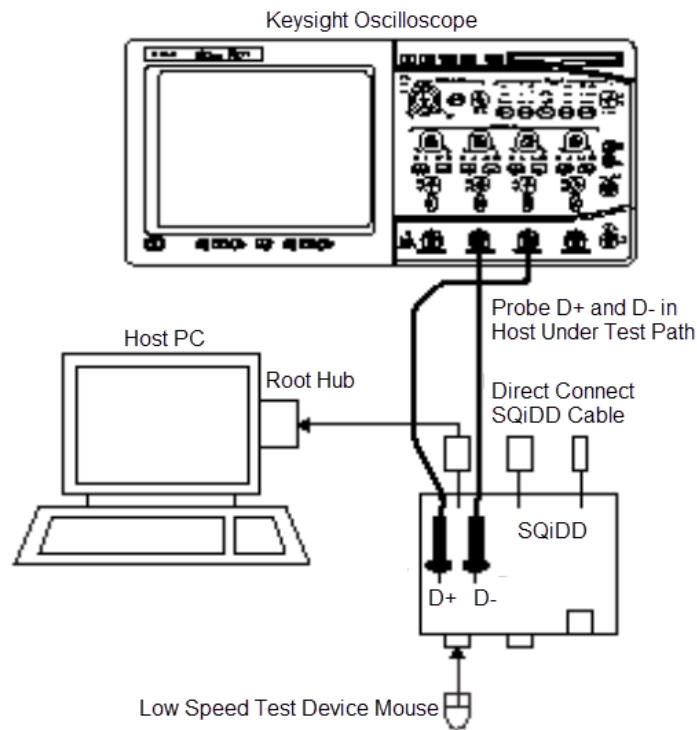

- 7 Check **I have completed these instructions.**

Running the Tests

- 1 Click **Run Tests**.

Viewing Test Results

- 1 When the Testing Complete dialog appears, click **OK**.
The Results tab shows the test results.

Host Full Speed Signal Quality Test

Equipment Used

Table 36 Equipment Used in Host Downstream Full Speed Signal Quality Test

Quantity	Item	Description/Model
1	Oscilloscope	Keysight 90000A Series or S-Series
2	Probe type	Passive or active probe
1	Host test bed computer	Any computer with hi-speed USB ports
1	SQiDD board	Keysight E2646B
1	full speed USB device	Intel Create and Share USB camera, P/N 735147-001, Model #: CS330
5	USB self-powered hubs	Any listed on USB-IF web site
6	5 meter USB cables	Any listed on USB-IF web site

Selecting the Tests

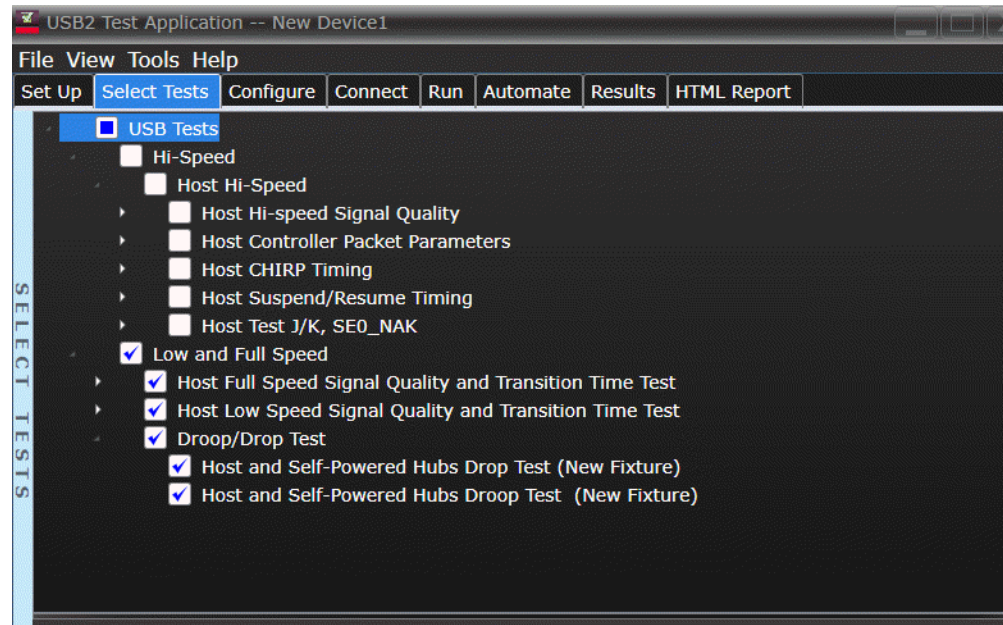

Connecting the Equipment

The USB automated test application will prompt you to perform these connection steps:

- 1 Use high-impedance converter with 10:1 passive probes or you may use active probes.
- 2 Attach the passive probes to the oscilloscope's Channel 3 and Channel 2 inputs.
- 3 Attach the SQiDD board to the root hub on the host under test.
- 4 Attach 5 self-powered hubs and a full-speed device to the same section of the SQiDD board. If the section has a switch, it should be set to ON. Hub #1 has to be a full-speed hub and hub #2 a Hi-speed hub. The other hubs can be either full speed or hi-speed hubs.

NOTE

1. E2697A is not needed for DS09000 series oscilloscope.

NOTE

Placing a full speed and/or a high-speed device downstream of a full speed hub forces both to operate in full speed mode.

- 5 Connect the oscilloscope Channel 2 probe to D- probe point of the device under test portion. Connect the oscilloscope Channel 3 probe to the D+ probe point of the device under test portion.
- 6 Exit the HS Electrical Test Tool if you have previously launched.

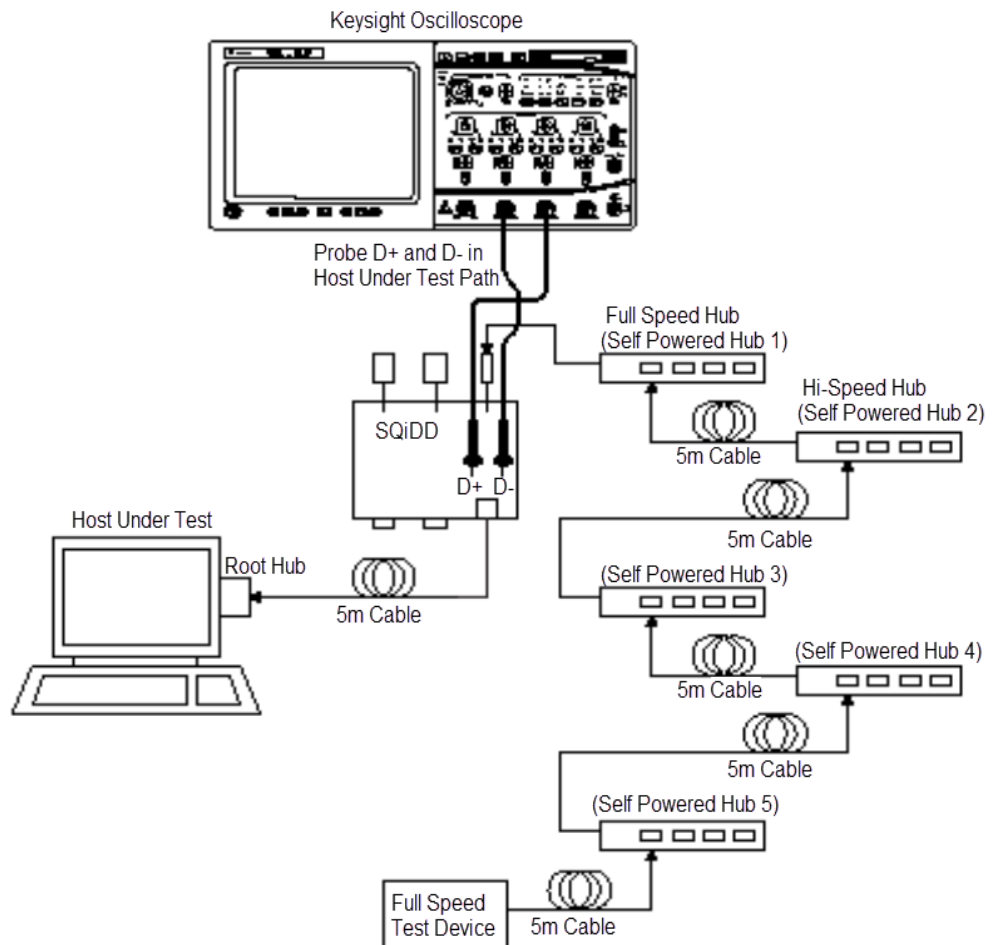

- 7 Check **I have completed these instructions.**

Running the Tests

- 1 Click **Run Tests**.

Viewing Test Results

- 1 When the Testing Complete dialog appears, click **OK**.
The Results tab shows the test results.

Hub Low Speed Signal Quality Test

Equipment Used

Table 37 Equipment Used in Hub Low Speed Signal Quality Test

Quantity	Item	Description/Model
1	Oscilloscope	Keysight 90000A Series or S-Series
2	Probe type	Passive or active probe
1	Host test bed computer	Any computer with hi-speed USB ports
1	SQiDD board	Keysight E2646B
1	low speed USB device	Logitech mouse, P/N 830311-1000, Model #: M-BB48
5	USB self-powered hubs	Any listed on USB-IF web site
5	5 meter USB cables	Any listed on USB-IF web site

Selecting the Tests

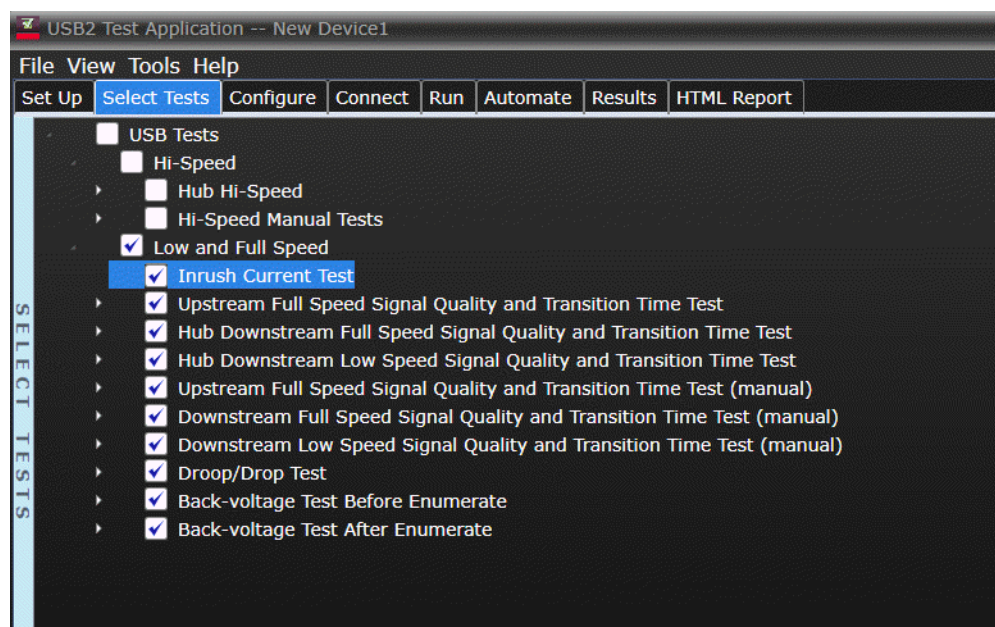

Configuring the Tests

Connecting the Equipment

The USB automated test application will prompt you to perform these connection steps:

- 1 Use high-impedance converter with 10:1 passive probes or you may use active probes.
- 2 Attach the passive probes to the oscilloscope's Channel 3 and Channel 2 inputs.
- 3 Attach the SQiDD board to the hub under test.
- 4 Attach the upstream port of the hub under test to the end of 4 self-powered hubs and a host system. Hub #1 has to be a full speed hub. The other hubs can be either full speed or hi-speed hubs.

NOTE

The best method to capture and analyze low-speed downstream signal quality is to capture both a keep-alive (low speed EOP) if present and a SOF packet. Hubs are required to generate keep-alives when there is full speed traffic and pass them on to low speed devices.

- 5 Attach a low speed device to the same section of the SQiDD board. If the section has a switch, it should be set to ON.
- 6 Connect the oscilloscope Channel 2 probe to D- probe point of the device under test portion. Connect the oscilloscope Channel 3 probe to the D+ probe point of the device under test portion.
- 7 Exit the HS Electrical Test Tool if you have previously launched it.

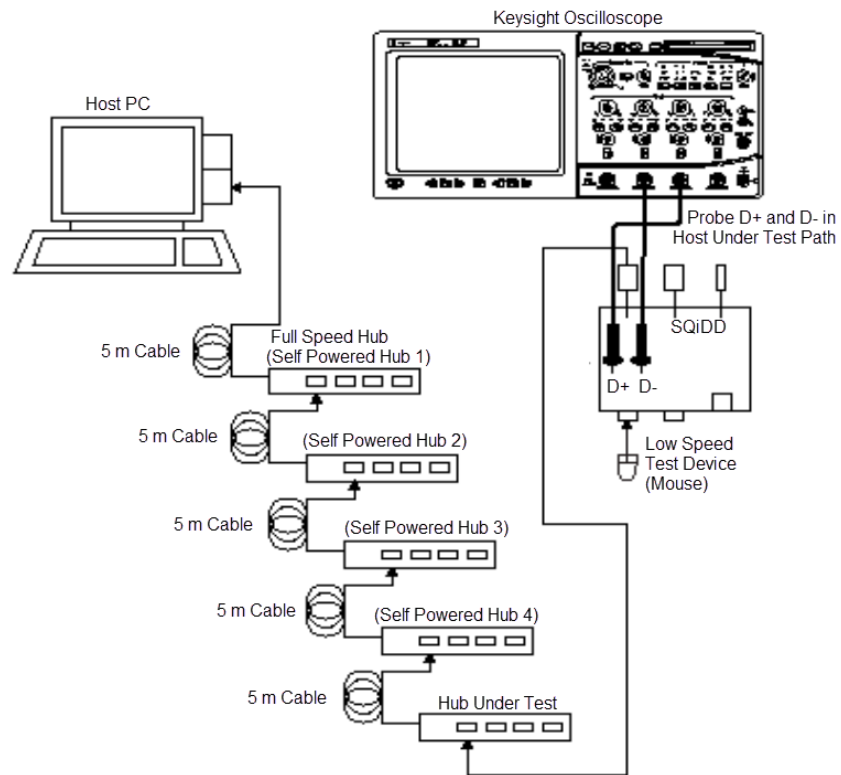

- 8 Check **I have completed these instructions**

Running the Tests

- 1 Click **Run Tests**.

Viewing Test Results

- 1 When the Testing Complete dialog appears, click **OK**.
The Results tab shows the test results.

Hub Downstream Full Speed Signal Quality Test

Equipment Used

Table 38 Equipment Used in Hub Downstream Full Speed Signal Quality Test

Quantity	Item	Description/Model
1	Oscilloscope	Keysight 90000A Series or S-Series
2	Probe type	Passive or active probe
1	Host test bed computer	Any computer with hi-speed USB ports
1	SQiDD board	Keysight E2646B
1	full speed USB device	Intel Create and Share USB camera, P/N 735147-001, Model #: CS330
5	USB self-powered hubs	Any listed on USB-IF web site
6	5 meter USB cables	Any listed on USB-IF web site

Selecting the Tests

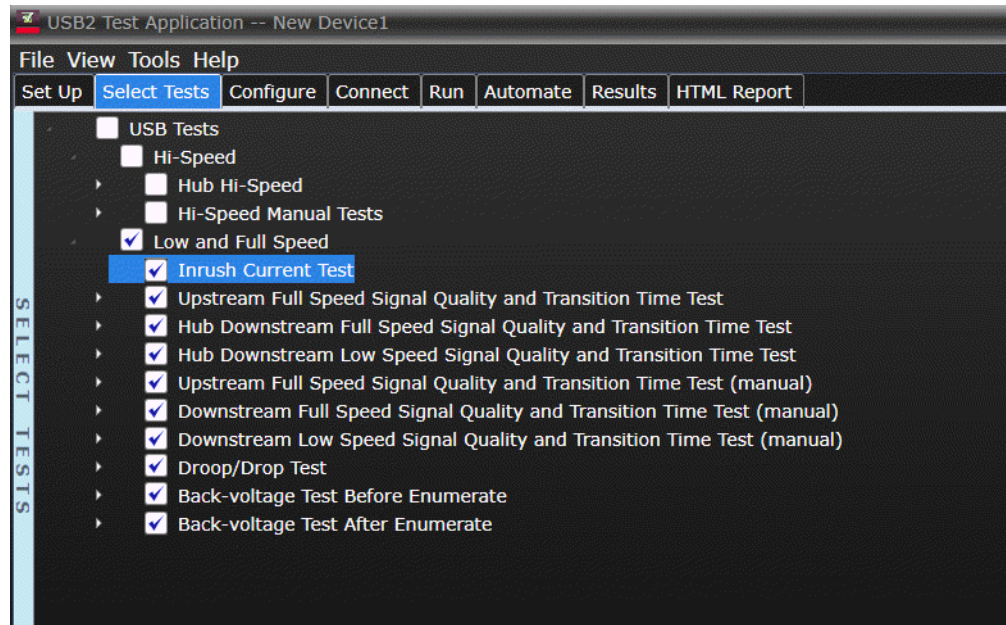

Connecting the Equipment The USB automated test application will prompt you to perform these connection steps:

- 1 Use high-impedance converter with 10:1 passive probes or you may use active probes.
- 2 Attach the passive probes to the oscilloscope's Channel 3 and Channel 2 inputs.
- 3 Attach the SQiDD board to the hub under test.
- 4 Attach the upstream port of the hub under test to the end of 4 self-powered hubs and a host system. Hub #1 has to be a full-speed hub and hub #2 a Hi-speed hub. The other hubs can be either full speed or hi-speed hubs.

NOTE

Placing a full speed and/or a high-speed device downstream of a full speed hub forces both to operate in full speed mode.

- 5 Attach a full speed device to the same section of the SQiDD board. If the section has a switch, it should be set to ON.
- 6 Connect the oscilloscope Channel 2 probe to D- probe point of the device under test portion. Connect the oscilloscope channel Channel 3 probe to the D+ probe point of the device under test portion.
- 7 Exit the HS Electrical Test Tool if you have previously launched it.

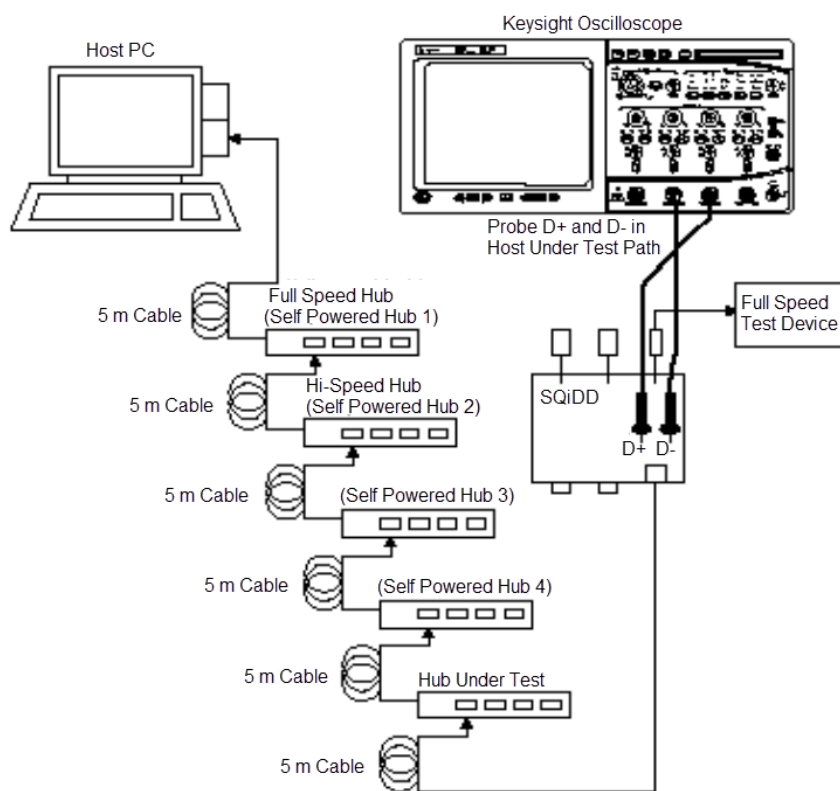

- 8 Check **I have completed these instructions.**

Running the Tests

- 1 Click **Run Tests**.

Viewing Test Results

- 1 When the Testing Complete dialog appears, click **OK**.
The Results tab shows the test results.

Upstream Signal Quality Test

Upstream Low Speed Test

Equipment Used

Table 39 Equipment Used in Upstream Low Speed Signal Quality Test

Quantity	Item	Description/Model
1	Oscilloscope	Keysight 90000A Series or S-Series
3	Probe type	Passive or active probe
1	Host test bed computer	Any computer with hi-speed USB ports
1	SQiDD board	Keysight E2646B
1	low speed USB device	Logitech mouse, P/N 830311-1000, Model #: M-BB48
5	USB self-powered hubs	Any listed on USB-IF web site
6	5 meter USB cables	Any listed on USB-IF web site

Selecting the Tests

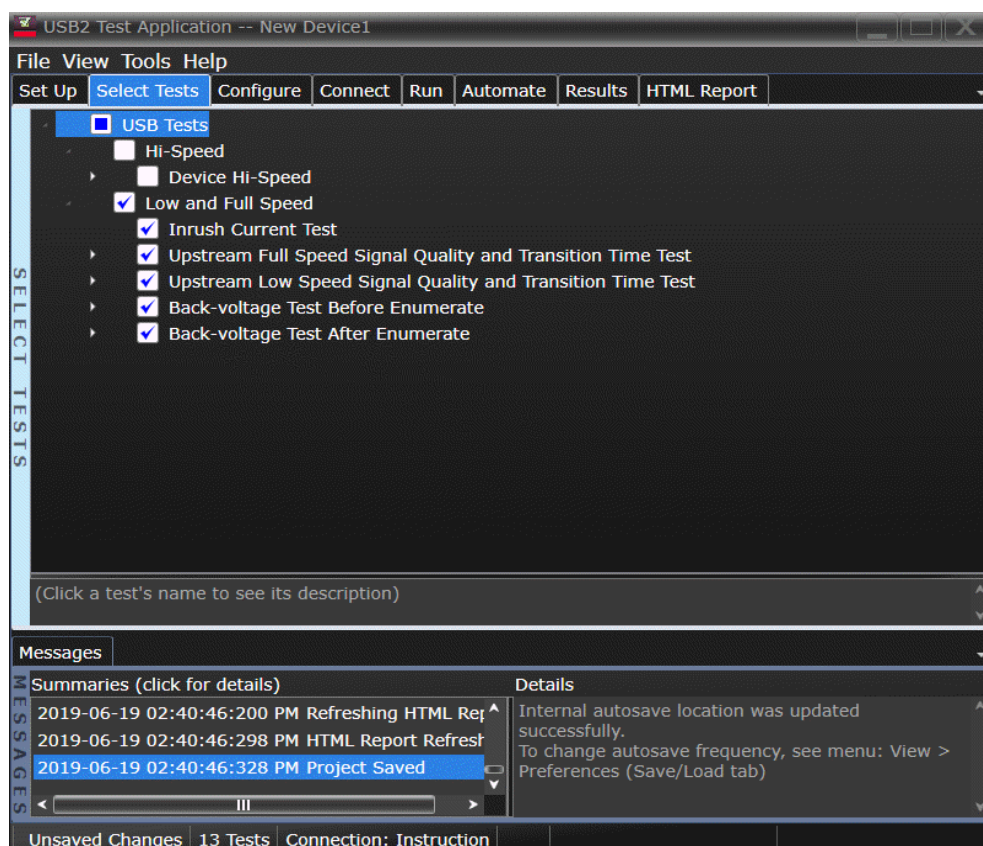

Connecting the Equipment The USB automated test application will prompt you to perform these connection steps:

- 1 Use high-impedance converter with 10:1 passive probes or you may use active probes.
- 2 Attach the passive probes to the oscilloscope's Channel 2, Channel 3 and Channel 1 inputs.
- 3 Attach the SQiDD board to two USB ports at the end of 5 self-powered hubs and a host system. Hub #1 has to be a hi-speed hub and hub #2 has to be a full speed hub. The rest of the hubs can be either hi-speed or full speed hubs.

NOTE

Placing a full speed and/or a high-speed device downstream of a full speed hub forces both to operate in full speed mode.

- 4 Attach a low speed device under test to the same section of the SQiDD board. If the section has a switch, it should be set to ON.
- 5 Attach another low speed device to the adjacent section of the SQiDD board. This is for triggering purposes.
- 6 Connect the oscilloscope Channel 2 probe to D- probe point of the device under test portion. Connect the oscilloscope Channel 3 probe to the D+ probe point of the device under test portion. Connect the oscilloscope Channel 1 probe to the D- probe point on the adjacent device section of the SQiDD board.

NOTE

E2697A is not needed for DS09000 series oscilloscope.

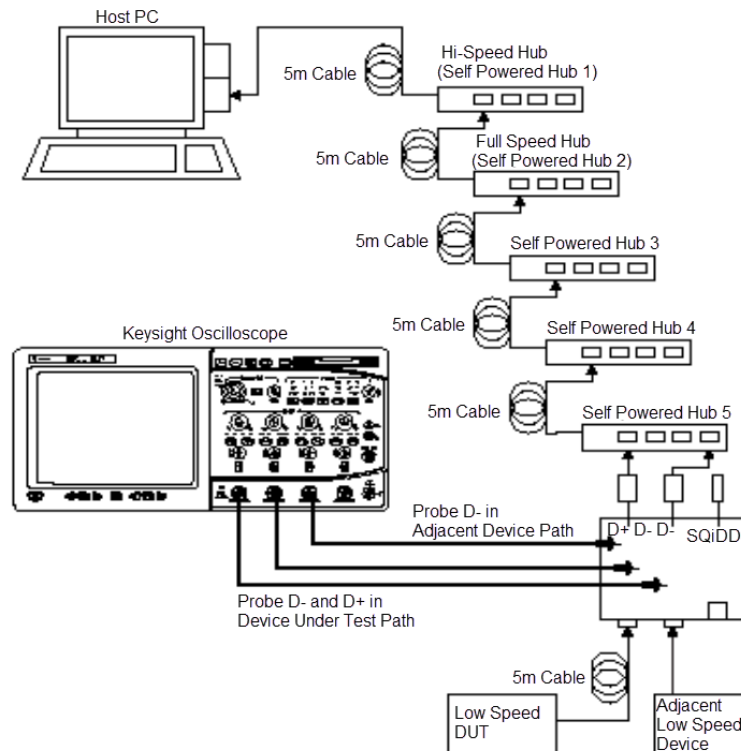

7 Check **I have completed these instructions.**

Running the Tests

1 Click **Run Tests.**

Test Instructions

The USB automated test application will prompt you to perform these steps:

- 1 Invoke the HS Electrical Test Tool software on the Hi-Speed Electrical Test Bed computer. Select **Device** and click the **[TEST]** button to enter the Device Test menu.

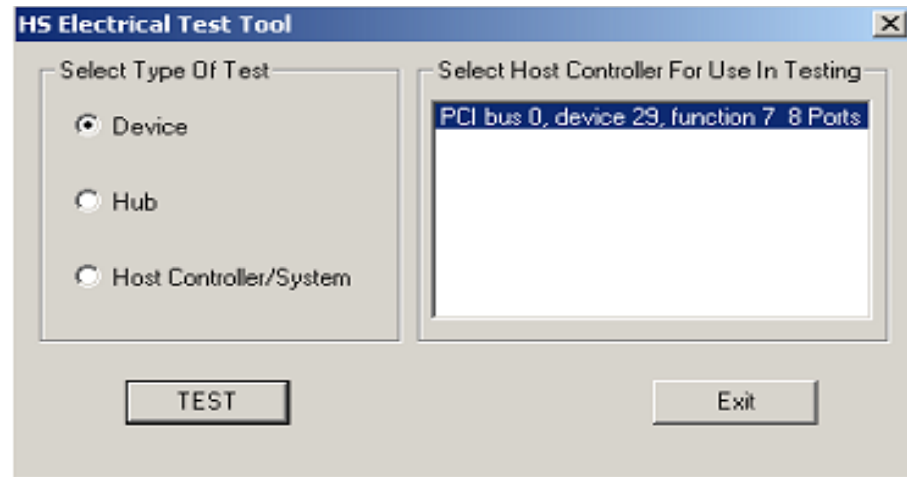

- 2 On the Device Test Menu of the HS Electrical Test Tool software, click **[Enumerate Bus]** once. All devices attached to the host controller should appear in the device enumeration list.
- 3 Highlight the device under test and select **LOOP DEVICE DESCRIPTOR** from the Device Command drop down menu. Click **EXECUTE** once.
- 4 If you do not know which VID/PID belongs to the device under test, unattach the device under test and enumerate the bus once. Then reattach the device under test and enumerate again, this time paying attention to the new device attached.

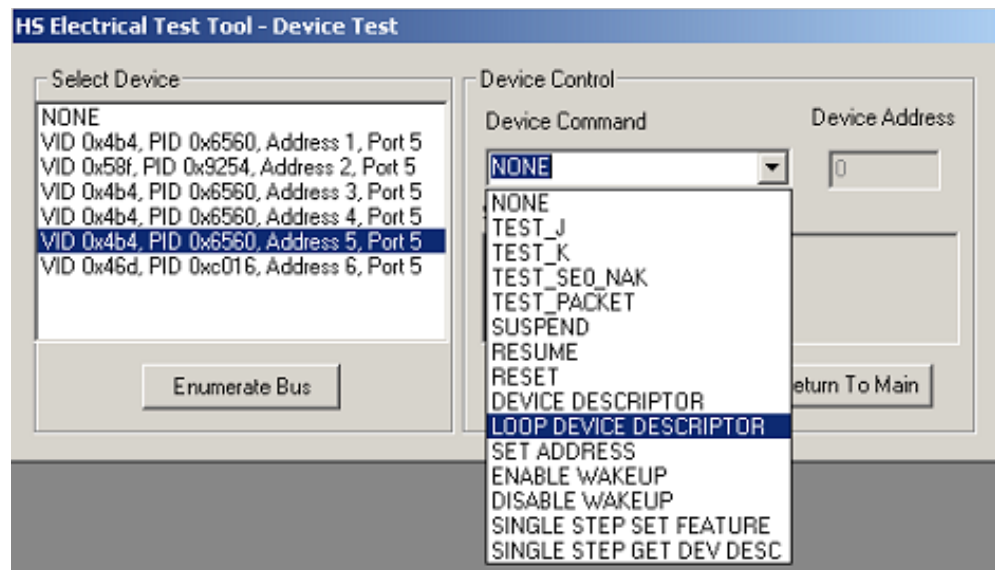

- 5 Click **OK** to close the Test Instructions dialog.

Viewing Test Results

- 1 When the Testing Complete dialog appears, click **OK**.
The Results tab shows the test results.

Upstream Full Speed Test

Equipment Used

Table 40 Equipment Used in Upstream Full Speed Signal Quality Test

Quantity	Item	Description/Model
1	Oscilloscope	Keysight 90000A Series or S-Series
3	Probe type	Passive or active probe
1	Host test bed computer	Any computer with hi-speed USB ports
1	SQiDD board	Keysight E2646B
1	full speed USB device	Intel Create and Share USB camera, P/N 735147-001, Model #: CS330
5	USB self-powered hubs	Any listed on USB-IF web site
6	5 meter USB cables	Any listed on USB-IF web site

Selecting the Tests



Connecting the Equipment The USB automated test application will prompt you to perform these connection steps:

- 1 Use high-impedance converter with 10:1 passive probes or you may use active probes.
- 2 Attach the passive probes to the oscilloscope's channel Channel 2, Channel 3, and Channel 1 inputs.
- 3 Attach the SQiDD board to two USB ports at the end of 5 self-powered hubs and a host system. Hub #1 has to be a hi-speed hub and hub #2 has to be a full speed hub. The rest of the hubs can be either hi-speed or full speed hubs.

NOTE

Placing a full speed and/or a high-speed device downstream of a full speed hub forces both to operate in full speed mode.

- 4 Attach a full speed device under test to the same section of the SQiDD board. If the section has a switch, it should be set to ON.
- 5 Attach another full speed device to the adjacent section of the SQiDD board. This is for triggering purposes.

NOTE

Use a full-speed hub if device under test has embedded hub function. Otherwise the scope will falsely trigger.

- 6 Connect the oscilloscope Channel 2 probe to D- probe point of the device under test portion. Connect the oscilloscope Channel 3 probe to the D+ probe point of the device under test portion. Connect the oscilloscope Channel 1 probe to the D+ probe point on the adjacent device section of the SQiDD board.

NOTE

1. EE2697A is not needed for DSO9000 series oscilloscope.
 2. In the Full Speed test, use the USB required length cable:
 - When the device has a standard B-receptacle, use a 5m cable.
 - When the device has a mini-B receptacle, use a 4.5m cable.
 - When the device has a micro-B receptacle, use a 2m cable.
 - If the device has a captive or specific cable, no USB cable is required.
-

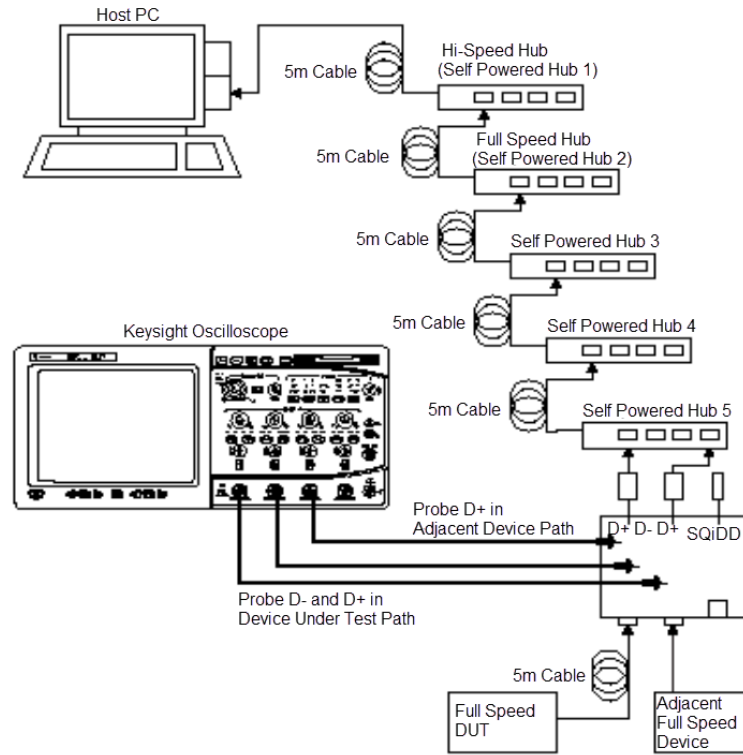

7 Check **I have completed these instructions.**

Running the Tests

- 1 Click **Run Tests.**

Test Instructions

The USB automated test application will prompt you to perform these steps:

- 1 Invoke the HS Electrical Test Tool software on the Hi-Speed Electrical Test Bed computer. Select **Device** and click the **[TEST]** button to enter the Device Test menu.

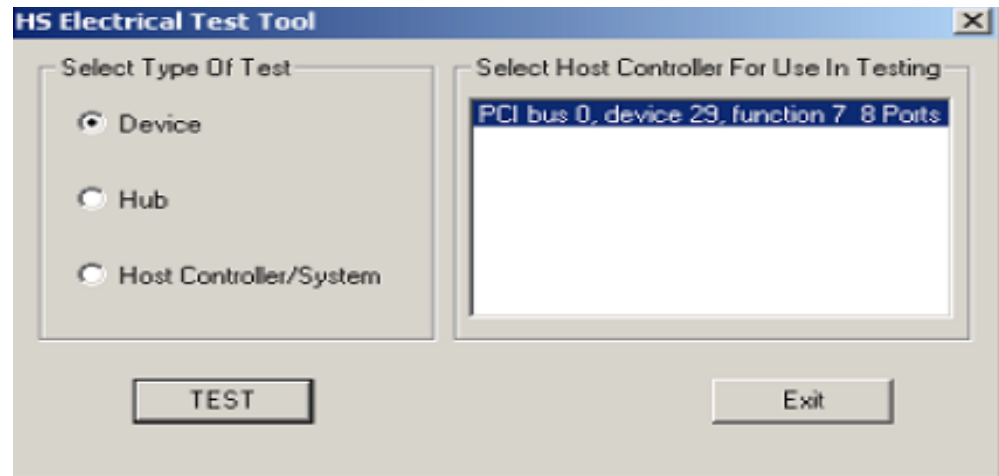

- 2 On the Device Test Menu of the HS Electrical Test Tool software, click **[Enumerate Bus]** once. All devices attached to the host controller should appear in the device enumeration list.
- 3 Highlight the device under test and select **LOOP DEVICE DESCRIPTOR** from the Device Command drop down menu. Click **EXECUTE** once.
- 4 If you do not know which VID/PID belongs to the device under test, unattach the device under test and enumerate the bus once. Then reattach the device under test and enumerate again, this time paying attention to the new device attached.

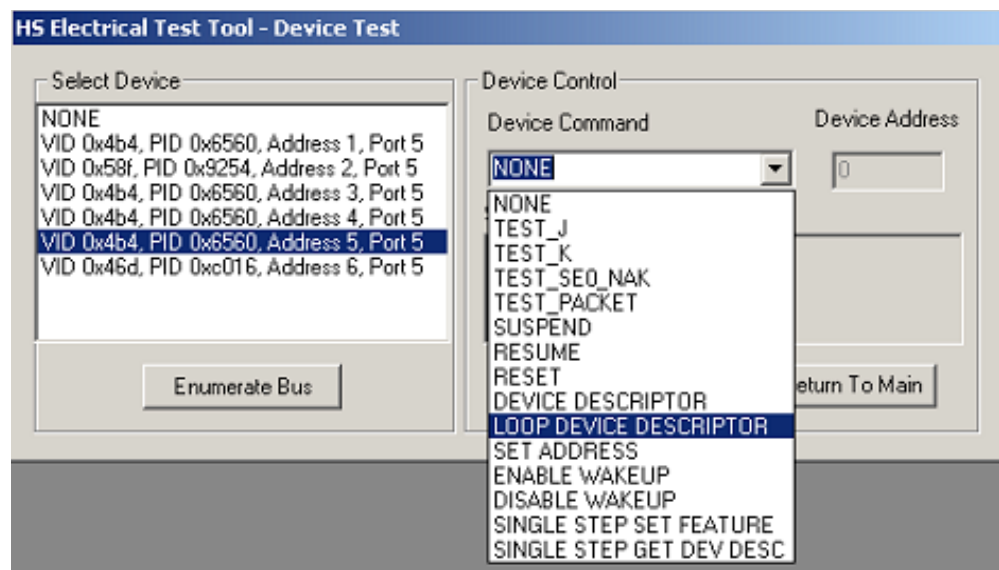

- 5 Click **OK** to close the Test Instructions dialog.

Viewing Test Results

- 1 When the Testing Complete dialog appears, click **OK**.
The Results tab shows the test results.

Back-Voltage Test Before Enumerate

Equipment Used

Table 41 Equipment Used in Back-Voltage Test

Quantity	Item	Description/Model
1	Digital Multimeter (DMM)	Keysight 34401A, 34461A, or equivalent
1	SQiDD board or back-voltage test fixture	Keysight E2646B
1	1 meter USB cable	Any listed on USB-IF web site

Selecting the Tests

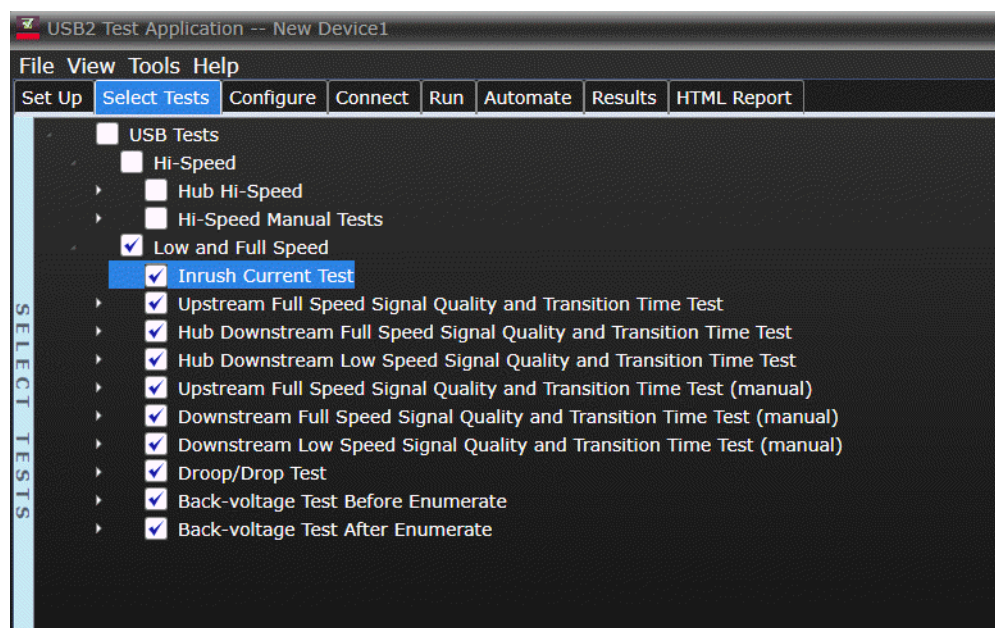

Configuring the Tests

Connecting the Equipment

The USB automated test application will prompt you to perform these connection steps:

- 1 Connect power supply to device/hub under test and connect the device/hub upstream port to the SQiDD board using a known good USB cable.

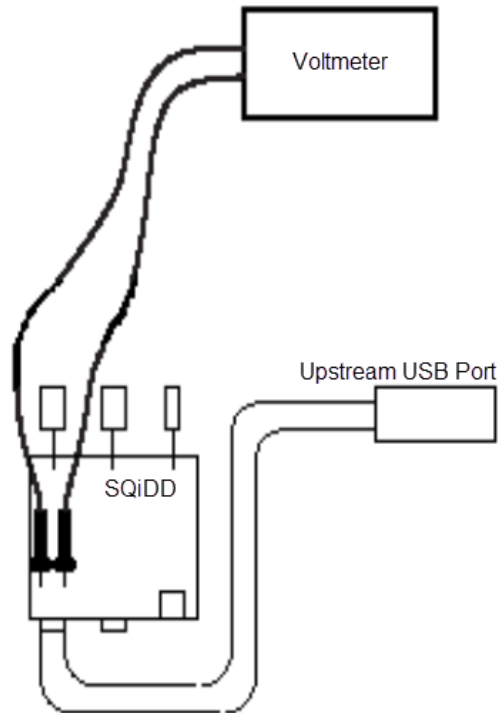
**NOTE**

The SQiDD fixture needs to have 15k ohms connected between:

- Vbus and Gnd.
- D+ and Gnd.
- D- and Gnd.

Running the Tests

- 1 Click **Run Tests**.

Test Instructions

VBUS

The USB automated test application will prompt you to: measure the voltage between Vbus and Gnd on the SQiDD board and record the value.

D+

The USB automated test application will prompt you to: measure the voltage between D+ and Gnd on the SQiDD board and record the value.

D-

The USB automated test application will prompt you to: measure the voltage between D- and Gnd on the SQiDD board and record the value.

Viewing Test Results

- 1 When the Testing Complete dialog appears, click **OK**.
The Results tab shows the test results.

Back-Voltage Test After Enumerate

Equipment Used

Table 42 Equipment Used in Back-Voltage Test

Quantity	Item	Description/Model
1	Digital Multimeter (DMM)	Keysight 34401A, 34461A, or equivalent
1	SQiDD board or back-voltage test fixture	Keysight E2646B
1	1 meter USB cable	Any listed on USB-IF web site

Selecting the Tests

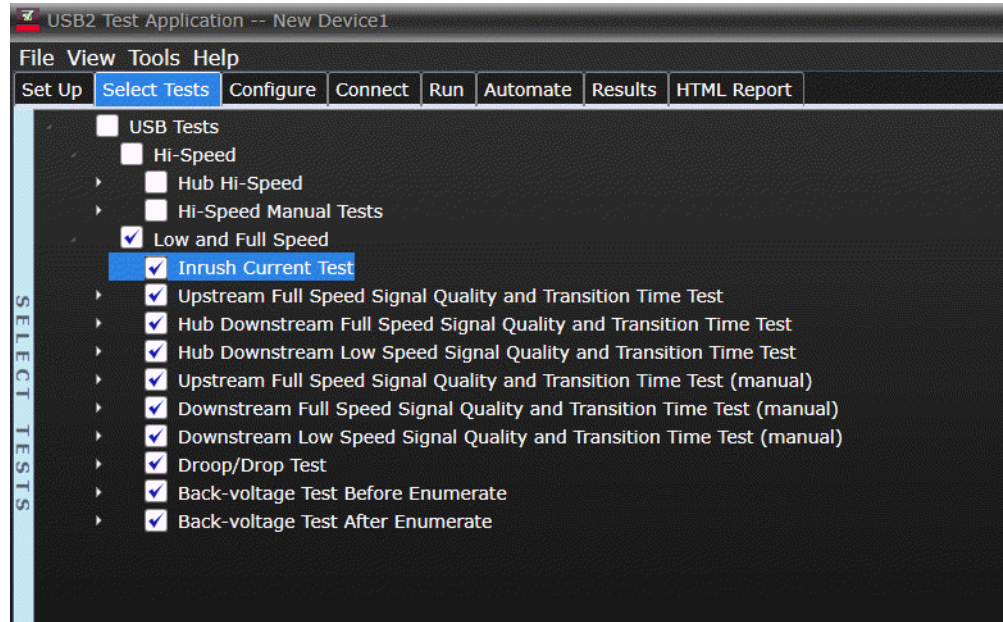

Configuring the Tests

Connecting the Equipment

The USB automated test application will prompt you to perform these connection steps:

- 1 Connect power supply to device/hub under test.

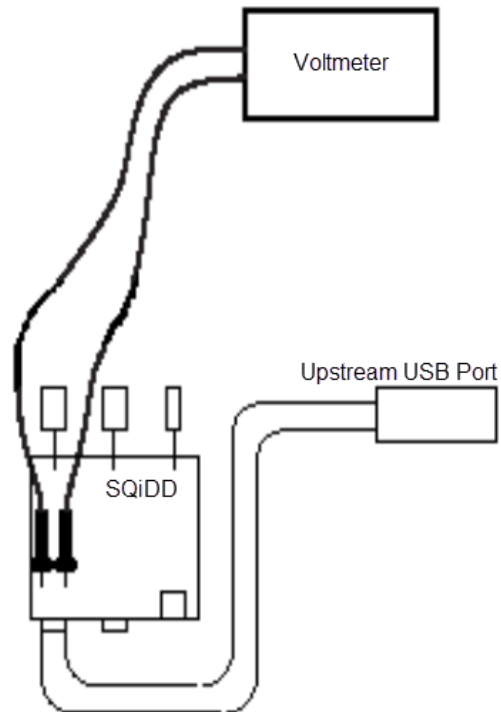

- 2 Plug device/hub under test into a known good host.
- 3 Verify proper enumeration.
- 4 Unplug USB cable from the host.
- 5 Connect the device/hub upstream port to the SQiDD board using a known good USB cable.

NOTE

The SQiDD fixture needs to have 15k ohms connected between:

- Vbus and Gnd.
- D+ and Gnd.
- D- and Gnd.

Running the Tests

- 1 Click **Run Tests**.

Test Instructions

VBUS

The USB automated test application will prompt you to: measure the voltage between Vbus and Gnd on the SQiDD board and record the value.

D+

The USB automated test application will prompt you to: measure the voltage between D+ and Gnd on the SQiDD board and record the value.

D-

The USB automated test application will prompt you to: measure the voltage between D- and Gnd on the SQiDD board and record the value.

Viewing Test Results

- 1 When the Testing Complete dialog appears, click **OK**.
The Results tab shows the test results.

8 Embedded Host Hi-Speed Tests

Embedded Host Hi-Speed Signal Quality Test	220
Embedded Host Controller Packet Parameters	226
Host CHIRP Timing	232
Host Suspend/Resume Timing	236
Host Test J/K, SEO_NAK	241

Embedded Host Hi-Speed Signal Quality Test

Equipment Used

Table 43 Equipment Used in Embedded Host Hi-Speed Signal Quality Test

Quantity	Item	Description/Model
1	Oscilloscope	Keysight S-Series, 9000A, 90000A, MXR, or UXR Series
2	SMA Cables	SMA Cables
1	PID/VID	Tools to select required test mode
1	Host Hi-Speed Signal Quality test fixture and 4" USB cable	Keysight E2649-66402
1	5V power supply	Keysight 8121-1966 or equivalent
1	USB cable	Micro AB receptacle

Selecting the Tests

Select the **Host** option and check **Embedded Host**.

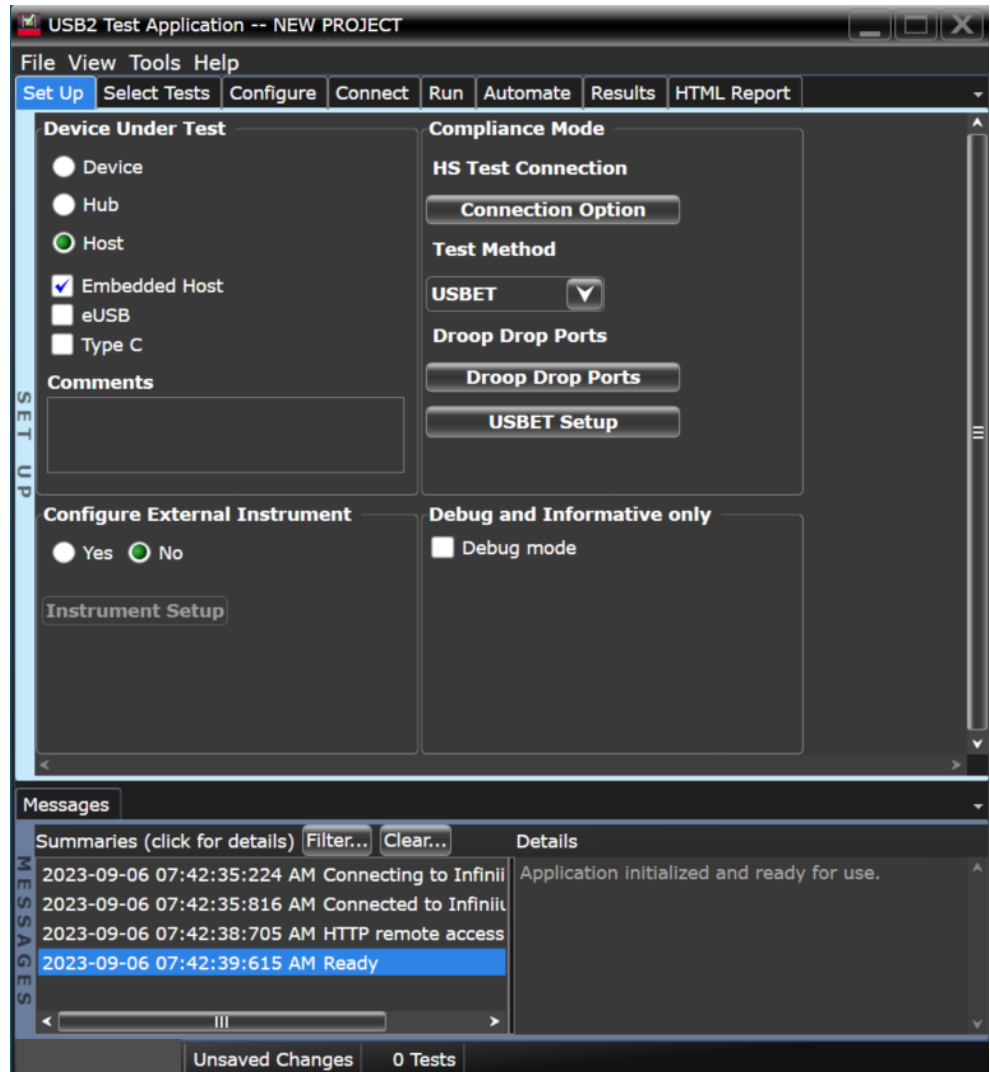

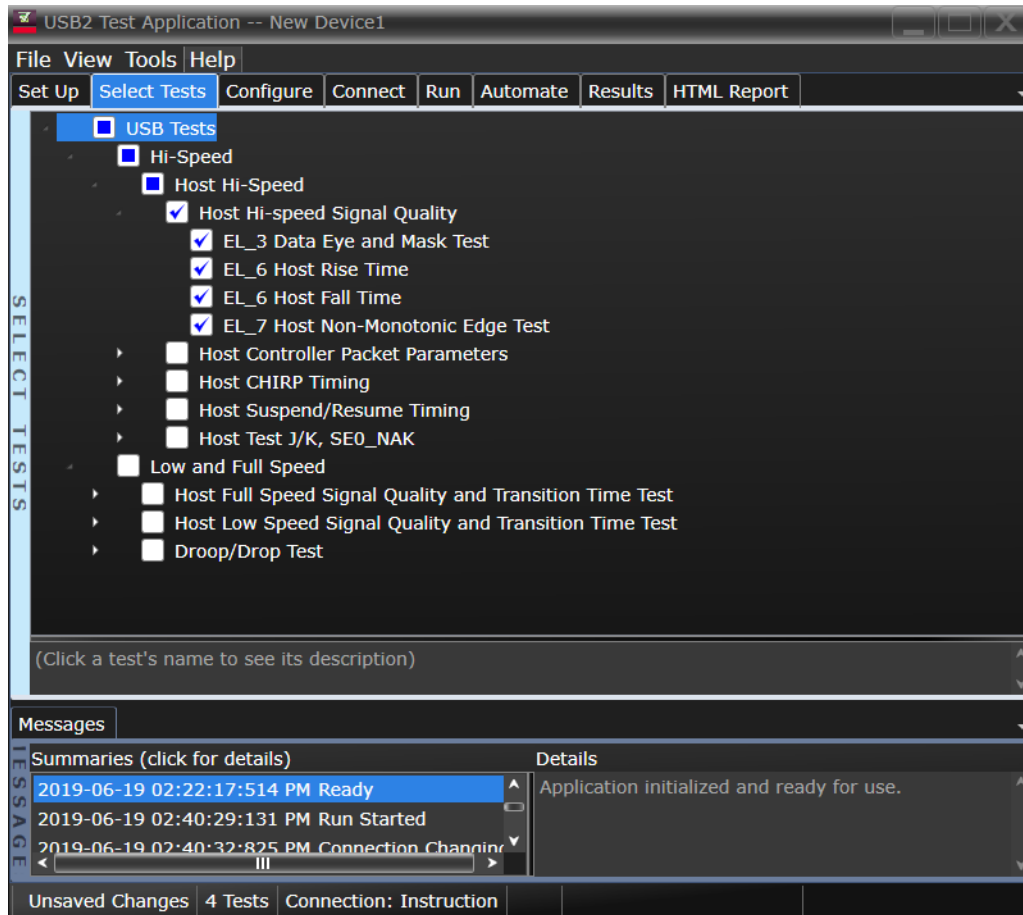

Configuring the Tests

Connecting the Equipment - Single-Ended Connection

- 1 Attach the 5V power supply to J5 of the E2649-26402 (E2645-66508 if you are using the old test fixture) Hi-Speed Signal Quality test fixture and verify the green Power LED (D1) is lit.
 - a Verify the green Power LED (D1) is lit and the yellow Test LED (D2) is not lit.
- 2 Attach the SMA cables on undefined and undefined to SMA connectors D+ and D- of the test fixture.
- 3 Connect Embedded host port under test to the [TEST PORT] of the test fixture using the 4 inch USB cable.
- 4 Before connecting the PID/VID put it in the correct position by selecting Test_Packet.
- 5 Connect the PID/VID to the Initialize port.

NOTE

1. Single-ended connection is only available using E2649-26401/E2649-26402/E2649-26403.
2. If you are using differential test connections for E2649-26401/E2649-26402/E2649-26403, please terminate the SMA connector with 50 Ohm terminators.

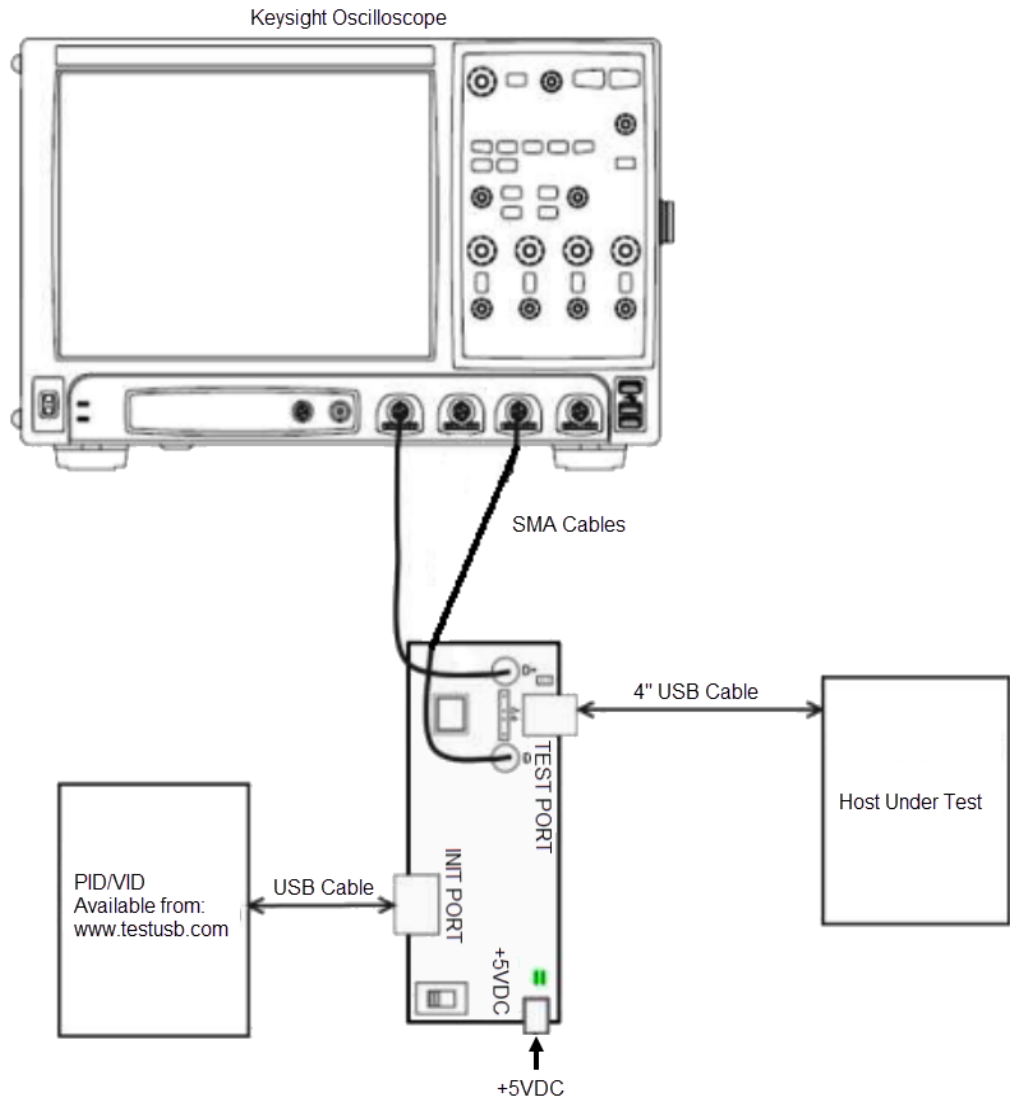

6 Check **I have completed these instructions.**

Connecting the Equipment - Differential Connection

- 1 Attach the 5V power supply to J5 of the E2649-26402 (E2645-66508 if you are using the old test fixture) Hi-Speed Signal Quality test fixture and verify the green Power LED (D1) is lit.
 - a Verify the green Power LED (D1) is lit and the yellow Test LED (D2) is not lit.
- 2 Attach a differential probe on Channel 1 to D+ and D- of TP2 of the test fixture, using a compatible header adapter.
- 3 Connect Embedded host port under test to the [TEST PORT] of the test fixture using the 4 inch USB cable.
- 4 Before connecting the PID/VID put it in the correct position by selecting Test_Packet.
- 5 Connect the PID/VID to the Initialize port.

NOTE

1. If you are using E2649-26401/E2649-26402/E2649-26403/E2649-26404 you would not need to use the damped header adapter.
2. If you are using differential test connections for E2649-26401/E2649-26402/E2649-26403, please terminate the SMA connector with 50 Ohm terminators.

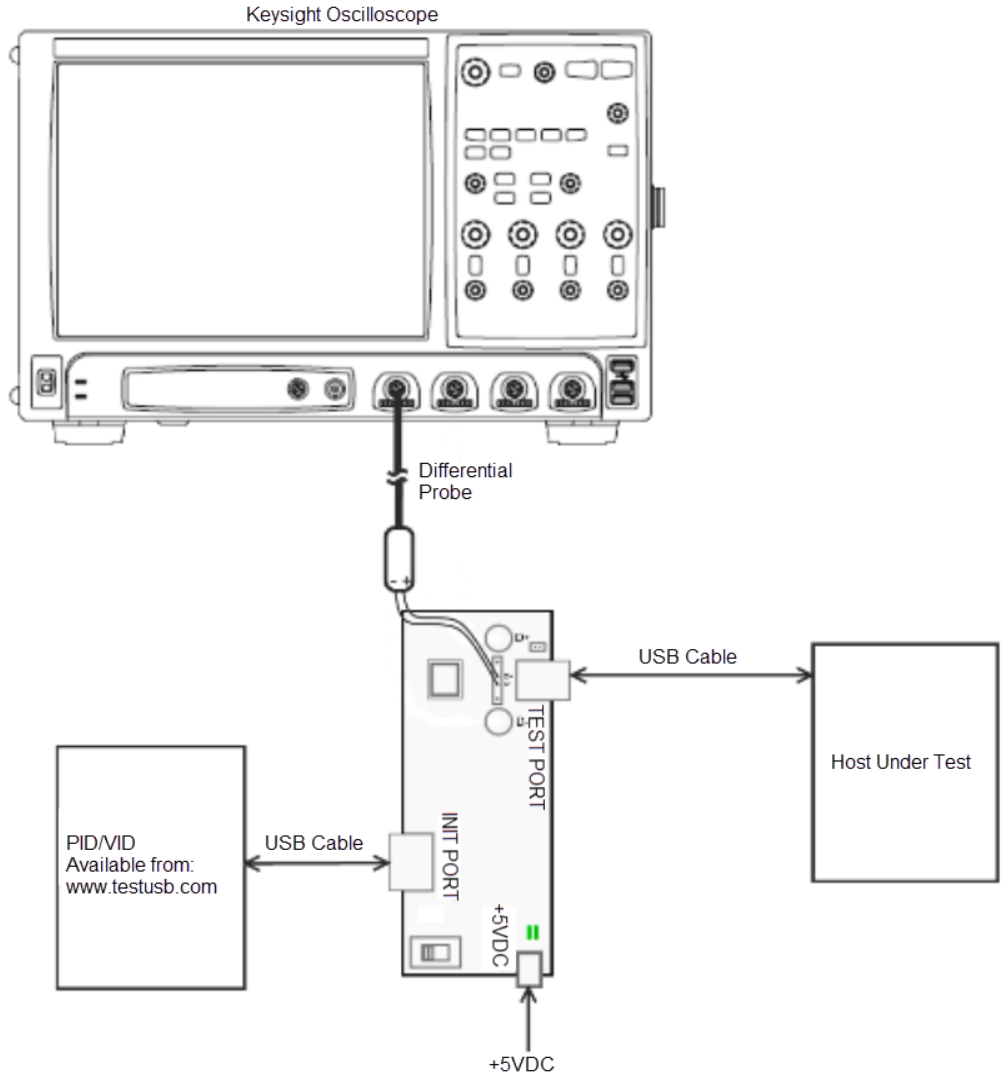

6 Check **I have completed these instructions.**

Running the Tests

- 1 Click **Run Tests.**

Test Instructions

- 1 The USB automated test application will prompt you to perform these steps:
- 2 Host enumerates the PID/VID and responds to send continuously Test_Packet.

- 3 Flip the switch of the test fixture that switches the termination on. LED power and Test mode illuminate (Orange LED lit).
- 4 You should see the transmitted test packet on the oscilloscope as below.

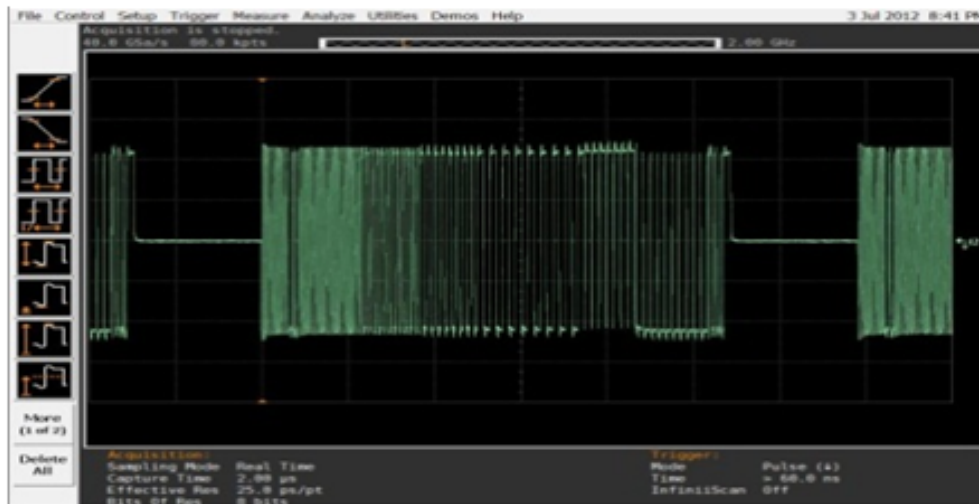

- 5 Click **OK** to close the Test Instructions dialog.

EL_6 Rise Time

EL_6 Fall Time

EL_3 Data Eye and Mask Test

After viewing the test results, click **OK** to close the Test Instructions dialog.

EL_7 Non-Monotonic Edge Test

Viewing Test Results

When the Testing Complete dialog appears, click **OK**. The Results tab shows the test results.

Embedded Host Controller Packet Parameters

Equipment Used

Table 44 Equipment Used in Embedded Host Controller Packet Parameters Tests

Quantity	Item	Description/Model
1	Oscilloscope	Keysight S-Series, 9000A, 90000A, MXR, or UXR Series
1	Probe type	Differential active (at least 2.5 GHz bandwidth) with E2678B socketed probe head
1	PID/VID	Tools to select required test mode
1	Device Hi-Speed Signal Quality test fixture and 4" USB cable	Keysight E2666B
1	5V power supply	Keysight 8121-1966 or equivalent
1	USB cable	Micro AB receptacle

Selecting the Tests

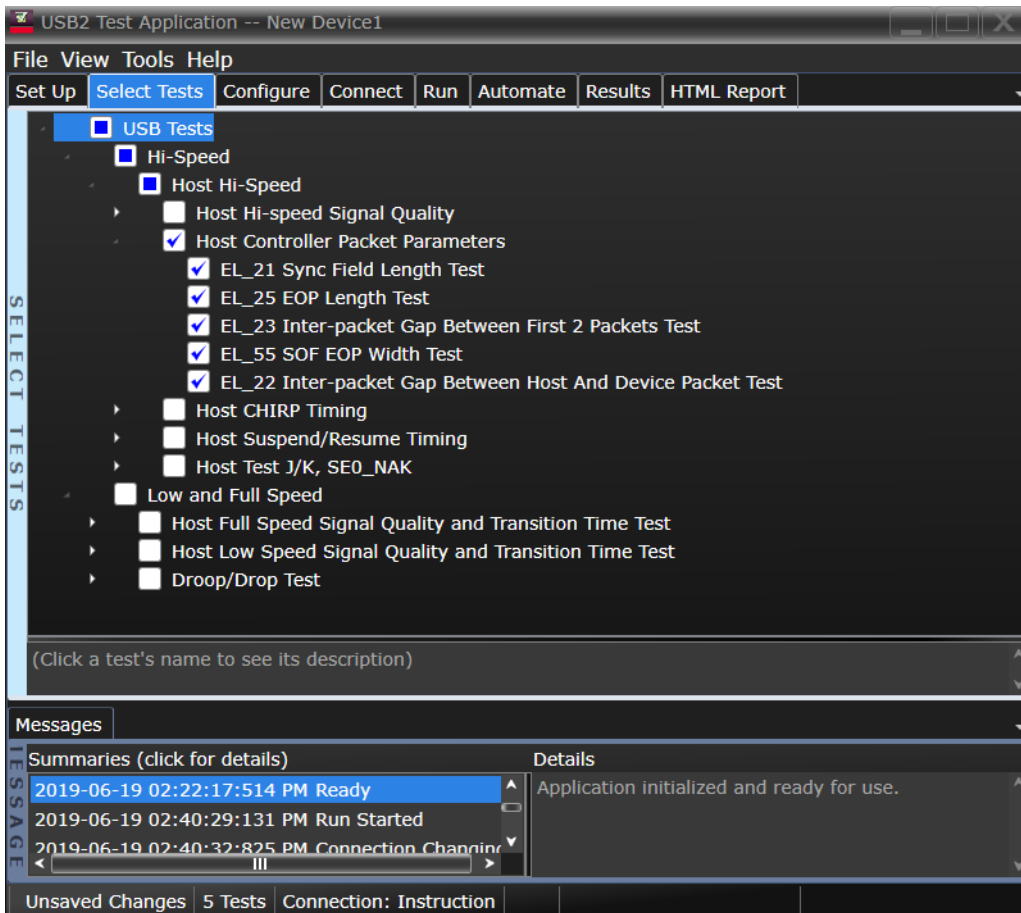

Configuring the Tests

Connecting the Equipment

The USB automated test application will prompt you to perform these connection steps:

- 1 Apply power to the test fixture and put test fixture switch test mode off. LED power illuminates (Green LED), Test mode OFF (Orange LED off).
- 2 Terminate the SMA probing points with 50 Ohm.
- 3 Attach a differential probe on Channel 1 to D+ and D- of TP2 of the test fixture, using a compatible header adapter.
- 4 Connect a short USB cable from the Test port of the fixture to the Embedded Host under test.
- 5 Before connecting the PID/VID put it in the correct position by selecting SINGLE_STEP_GET_DEVICE_DESCRIPTOR.
- 6 Connect the PID/VID to the Initialize port with USB cable.

NOTE

1. If you are using E2649-26401/E2649-26402/E2649-26403/E2649-26404 you would not need to use the damped header adapter.
 2. If you are using differential connection test connections for E2649-26401/E2649-26402/E2649-26403/E2649-26404, please terminate the SMA connector with 50 Ohm terminators.
-

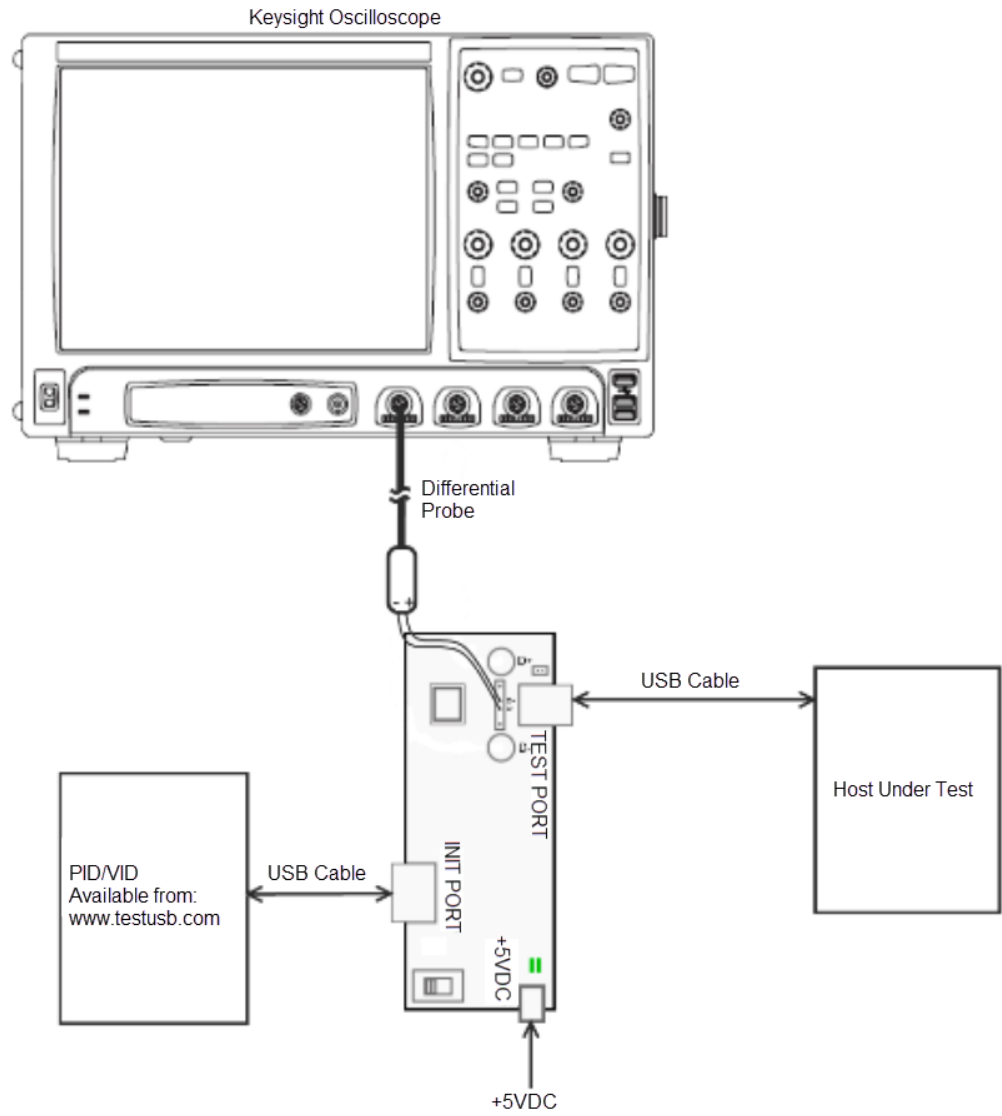

7 Check **I have completed these instructions.**

Running the Tests

- 1 Click **Run Tests**.

Test Instructions, Part 1

The USB automated test application will prompt you to perform these steps:

- 1 Host enumerates the PID/VID and responds to send SOFs for 15 seconds.

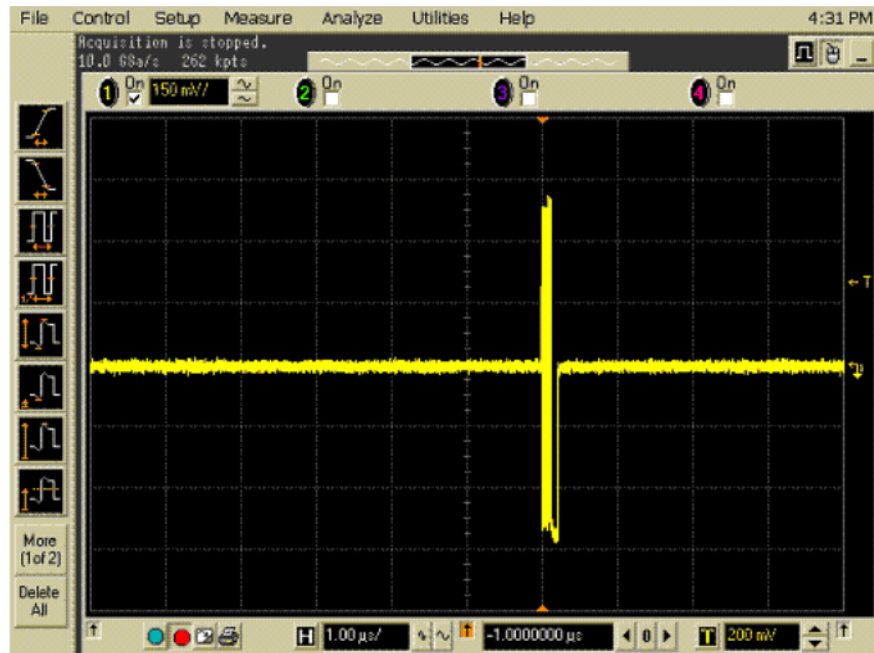

- 2 Click **OK** to close the Test Instructions dialog.

Test Instructions, Part 2

The USB automated test application will prompt you to perform these steps:

- 1 After 15 seconds of SOFs the host initiates the setup phase of the GetDescriptor() command. The host sends SETUP and DATA (first and second packet).
- 2 You should see the transmitted test packet on the oscilloscope as below.

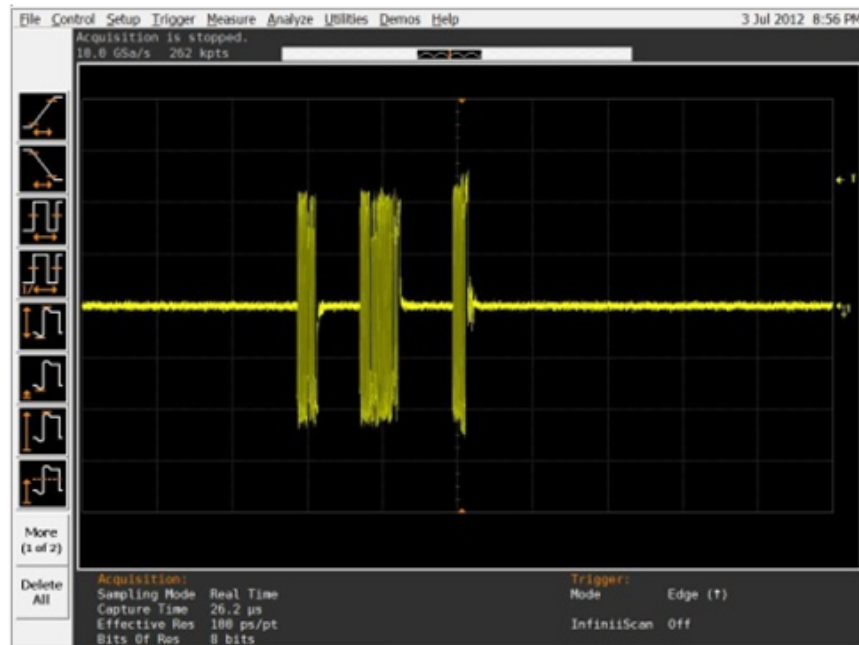

- 3 Click **OK** to close the Test Instructions dialog.

EL_21 Sync Field Length Test

EL_25 EOP Length Test

EL_23 Inter-packet Gap Between First 2 Packets Test

EL_55 SOF EOP Width Test

Connecting the Equipment

The USB automated test application will prompt you to perform these connection steps:

- 1 Before connecting the PID/VID put it in the correct position by selecting SINGLE_STEP_GET_DEVICE_DESCRIPTOR_DATA.
- 2 Connect with a short USB cable the PID/VID to the Initialize port

Test Instructions, Part 1

- 1 The host enumerates the PID/VID and request GetDescriptor(), then wait for 15 seconds.
- 2 Host issues an IN.
- 3 Host send an ACK.
- 4 You should see the transmitted test packet on the oscilloscope as below.

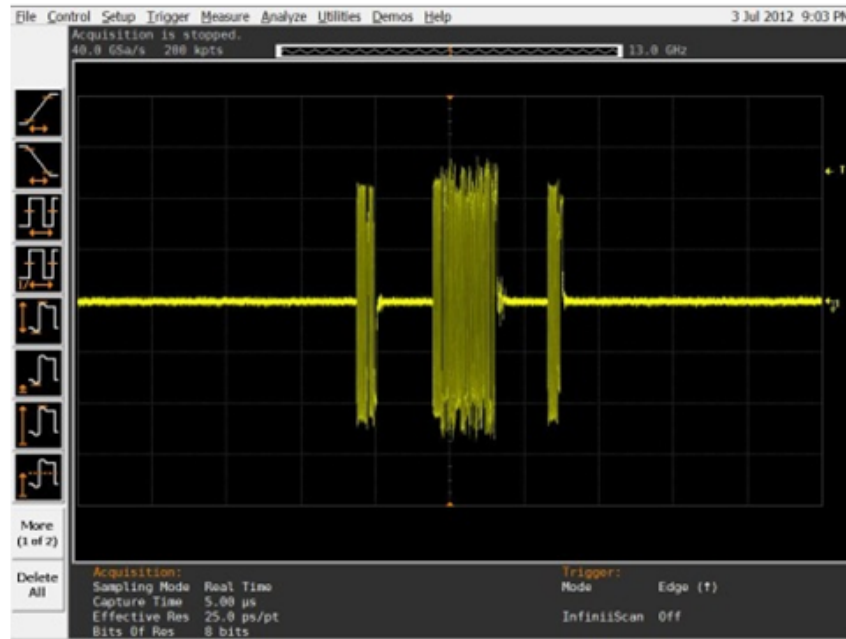

- 5 Click **OK** to close the Test Instructions dialog.

Viewing Test Results

- 1 When the Testing Complete dialog appears, click **OK**.

The Results tab shows the test results.

Host CHIRP Timing

Equipment Used

Table 45 Equipment Used in Embedded Host CHIRP Timing Tests

Quantity	Item	Description/Model
1	Oscilloscope	Keysight S-Series, 9000A, 90000A, MXR, or UXR Series
1	Probe type	Passive probe
1	PID/VID	Tools to select required test mode
1	Host Hi-Speed Signal Quality test fixture and 4" USB cable	Keysight E2649-66402
1	5V power supply	Keysight 8121-1966 or equivalent
1	USB cable	Micro AB receptacle

Selecting the Tests

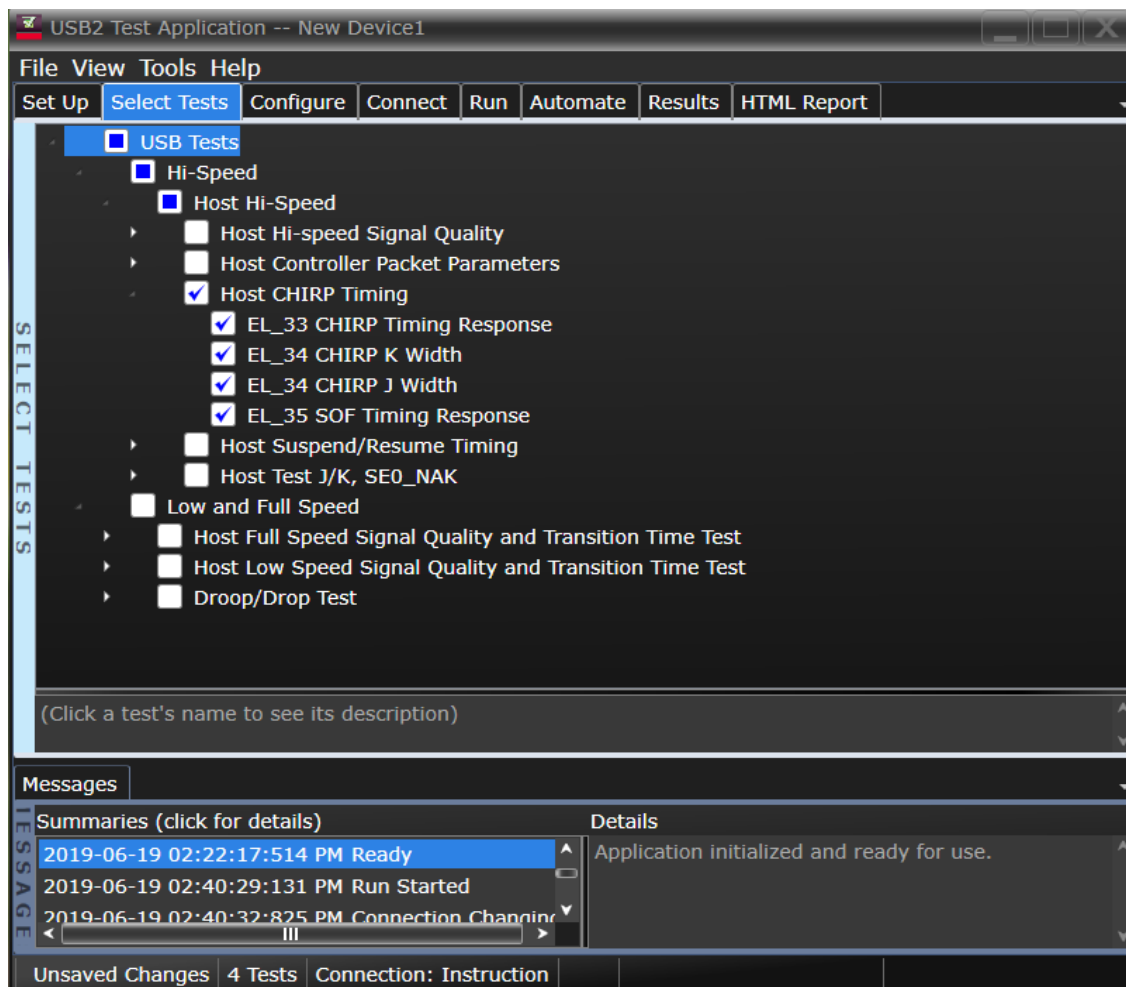

Configuring the Tests

Connecting the Equipment

The USB automated test application will prompt you to perform these connection steps:

- 1 Apply Power to the test fixture (E2649-26402) and put the test fixture switch test mode off. Verify that the Green LED is lit and Test mode off.
- 2 Connect the single-ended probe of channel 2 to D- of TP2.
- 3 Connect the single-ended probe of Channel 3 to D+ of TP2.
- 4 Connect a USB cable from the Test port of the fixture to the Embedded Host under test.

NOTE

1. If you are using E2649-26401/E2649-26402/E2649-26403, please terminate the SMA connector with 50 Ohm terminators.
2. E2697A is not needed for DS09000 series oscilloscope.

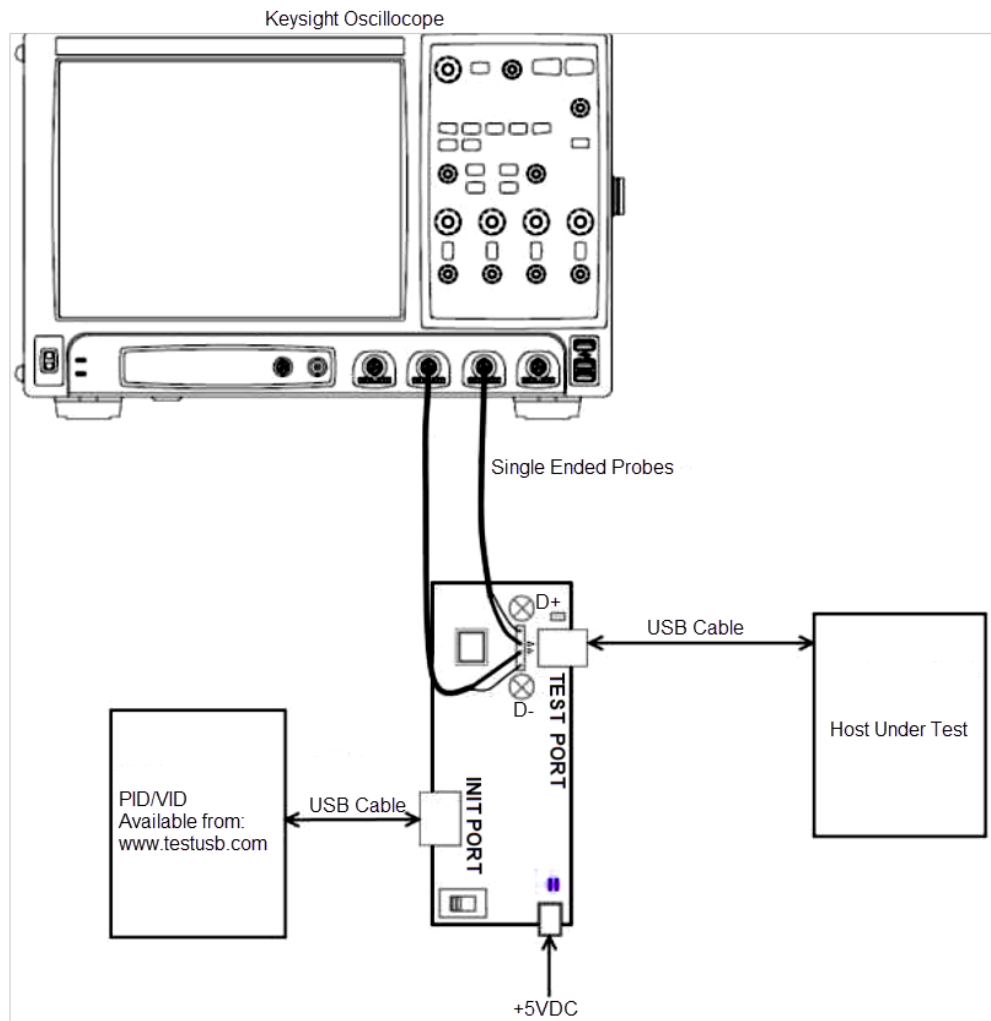

- 5 Check **I have completed these instructions.**

Running the Tests

- 1 Click **Run Tests**.

Test Instructions

The USB automated test application will prompt you to perform these steps:

- 1 Connect any known good high speed device to the initialize port.
You should capture the CHIRP handshake as in the below figure.

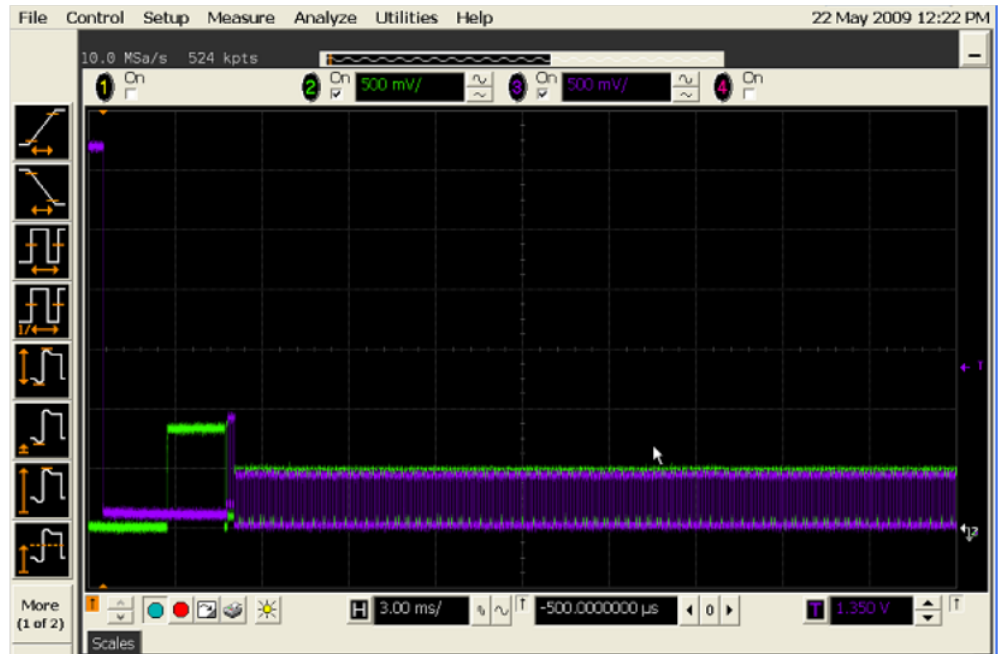

- 2 Click **OK** to close the Test Instructions dialog.

EL_33 CHIRP Timing Response

EL_34 CHIRP K Width

EL_34 CHIRP J Width

EL_35 SOF Timing Response

Viewing Test Results

- 1 When the Testing Complete dialog appears, click **OK**.

The Results tab shows the test results.

Host Suspend/Resume Timing

Equipment Used

Table 46 Equipment Used in Embedded Host Suspend/Resume Timing Tests

Quantity	Item	Description/Model
1	Oscilloscope	Keysight S-Series, 9000A, 90000A, MXR, or UXR Series
2	Probe Type	Passive probe
1	PID/VID	Tools to select required test mode
1	Host Hi-Speed Signal Quality test fixture and 4" USB cable	Keysight E2649-66402
1	5V power supply	Keysight 8121-1966 or equivalent
1	USB cable	Micro AB receptacle

Selecting the Tests

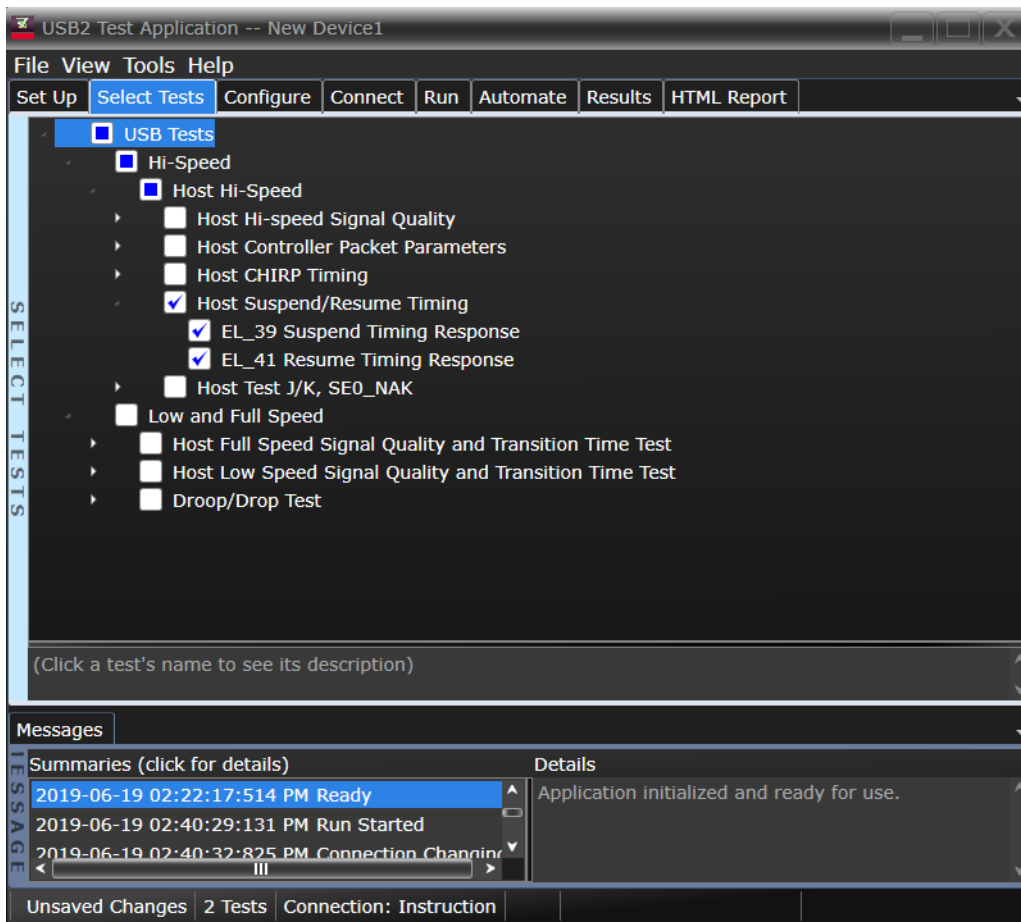

Configuring the Tests

Connecting the Equipment

The USB automated test application will prompt you to perform these connection steps:

- 1 Apply Power to the test fixture (E2649-26402) and put the test fixture switch test mode off. Verify that the Green LED is lit and Test mode off.
- 2 Connect the single-ended probe of channel 2 to D- of TP2.
- 3 Connect the single-ended probe of Channel 3 to D+ of TP2.
- 4 Connect a USB cable from the Test port of the fixture to the Embedded Host under test.
- 5 Connect any known good high speed device to the Initialize port.
- 6 Before connecting the PID/VID put it in the correct position by selecting HS_HOST_PORT_SUSPEND_RESUME.
- 7 Connect with a short USB cable the PID/VID to the Initialize port.

NOTE

1. If you are using E2649-26401/E2649-26402/E2649-26403, please terminate the SMA connector with 50 Ohm terminators.
 2. E2697A is not needed for DS09000 series oscilloscope.
-

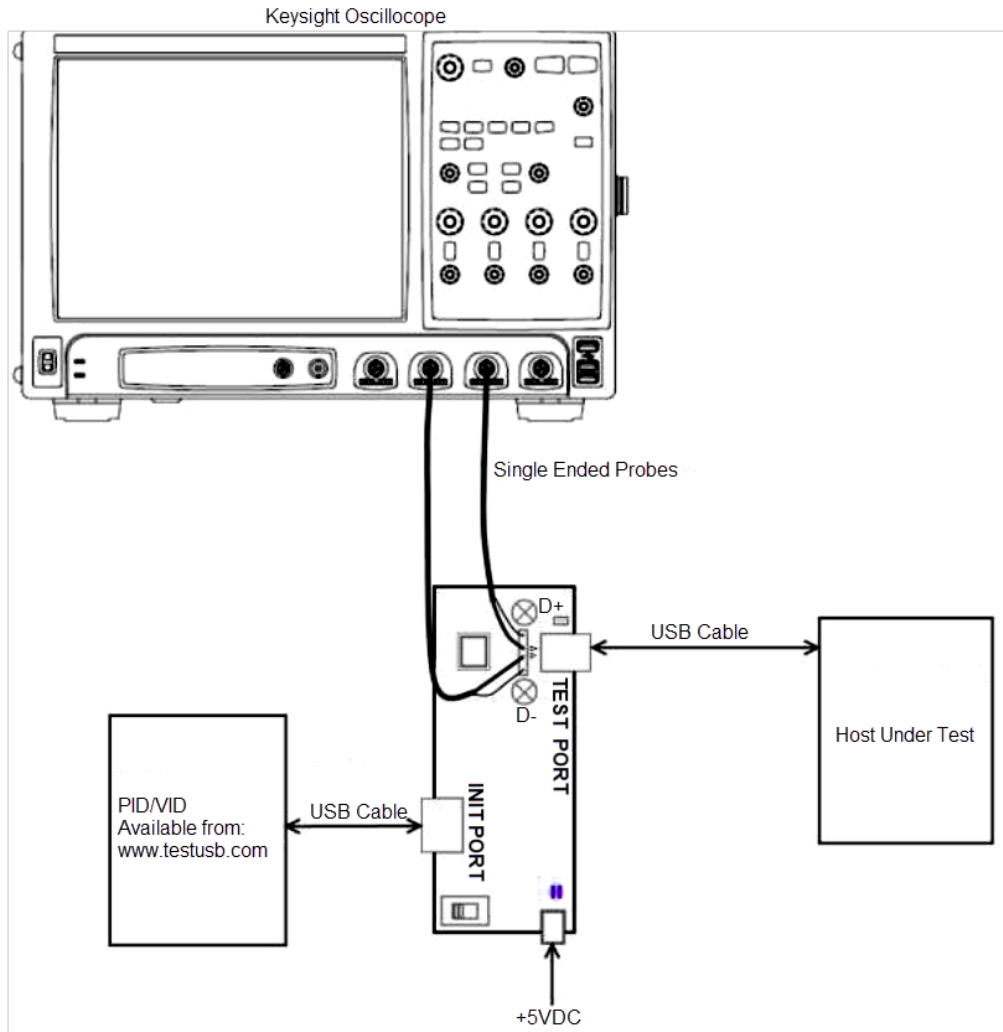

8 Check I have completed these instructions.

Running the Tests

- 1 Click **Run Tests**.

Test Instructions

EL_39 Suspend Timing Response

The USB automated test application will prompt you to perform these steps:

- 1 After 15 seconds the host port will enter Suspend state.

NOTE

PID/VID will enter Resume state after 15 seconds.

- 2 The captured transition should be as in the figure below.

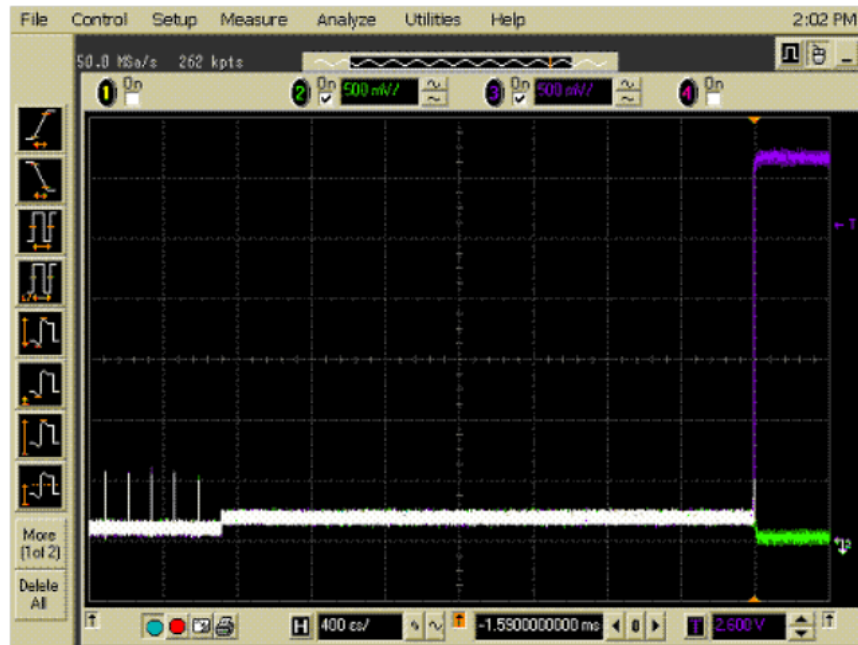

- 3 Click **OK** to close the Test Instructions dialog.

EL_41 Resume Timing Response

The USB automated test application will prompt you to perform these steps:

- 1 After 15 seconds of suspend state the host shall issue a ResumeK state on the bus, then continue sending SOFs.
- 2 The captured transition should be as in the figure below.

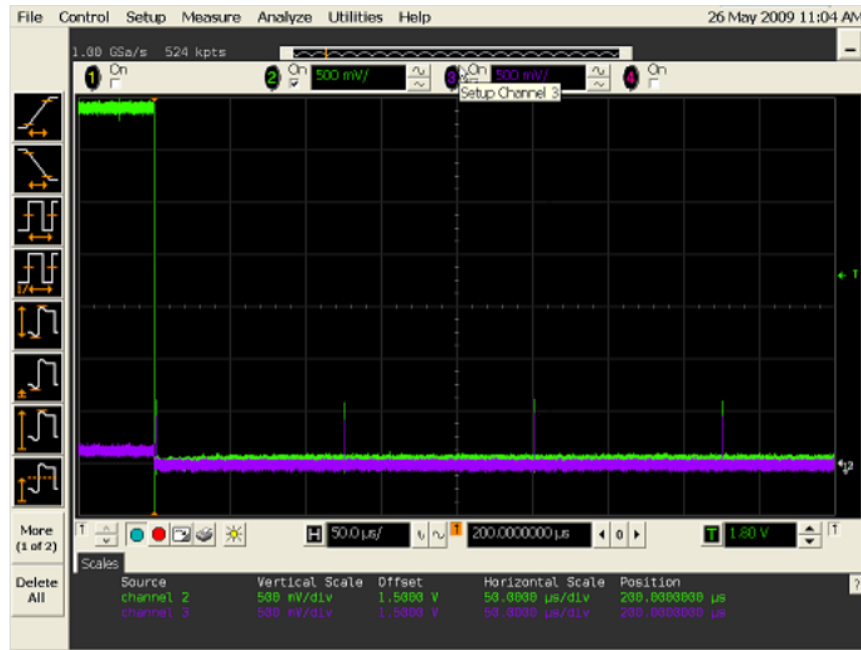

- 3 Click **OK** to close the Test Instructions dialog.

Viewing Test Results

- 1 When the Testing Complete dialog appears, click **OK**.
The Results tab shows the test results.

Host Test J/K, SEO_NAK

Equipment Used

Table 47 Equipment Used in Embedded Host Test J/K, SEO_NAK Tests

Quantity	Item	Description/Model
1	Digital Multimeter (DMM)	Keysight 34461A or equivalent
1	PID/VID	Tools to select required test mode
1	Host Hi-Speed Signal Quality test fixture and 4" USB cable	Keysight E2649-66402
1	5V power supply	Keysight 8121-1966 or equivalent
1	USB cable	Micro AB receptacle

Selecting the Tests

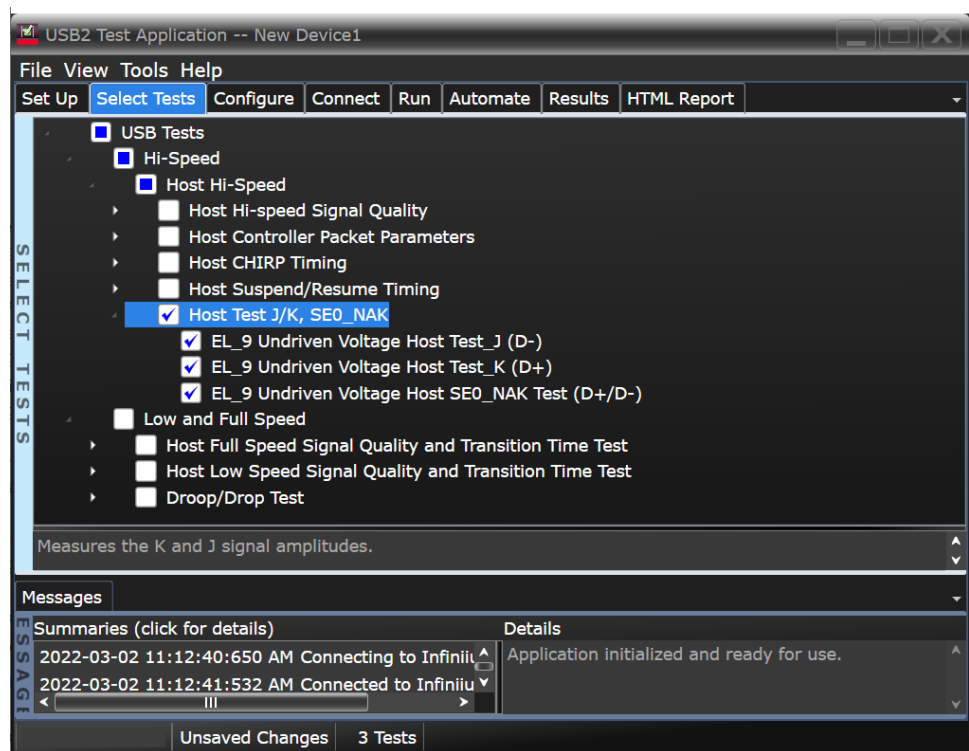

Configuring the Tests

Connecting the Equipment (Using Probes)

The USB automated test application will prompt you to perform these connection steps:

- 1 Apply power to the test fixture (E2649-26402) and put test fixture switch test mode off. LED power illuminate (Green LED), Test mode Off (Orange LED).
- 2 Connect a short USB cable from the Test port of the fixture to the Embedded Host under test.

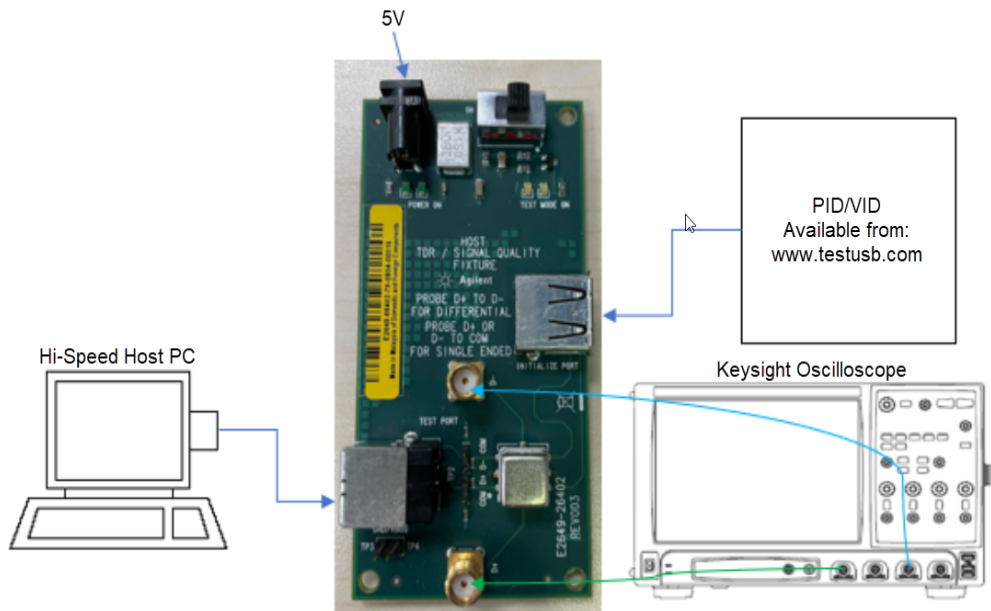

- 3 Check **I have completed these instructions.**

Connecting the Equipment (Using Voltmeter)

The USB automated test application will prompt you to perform these connection steps:

- 1 Apply power to the test fixture (E2649-26402) and put test fixture switch test mode off. LED power illuminate (Green LED), Test mode Off (Orange LED)
- 2 Connect a short USB cable from the Test port of the fixture to the Embedded Host under test.
- 3 Using a [Voltmeter] for voltage measurement.
- 4 Connect PIDVID to [INIT PORT]

NOTE

1. If you are using E2649-26401/E2649-26402/E2649-26403, please terminate the SMA connector with 50 Ohm terminators.
2. E2697A is not needed for DSO9000 series oscilloscope.

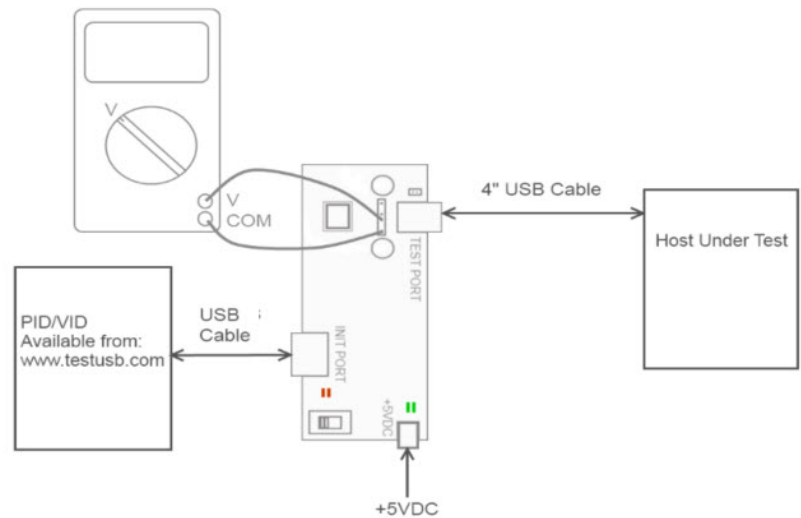

- 5 Check **I have completed these instructions.**

Running the Tests

- 1 Click **Run Tests**.

Test Instructions

EL_9 Undriven Voltage Host Test_J (D-) Test

- 1 Before connecting the PID/VID put it in the correct position by selecting Test_J
- 2 Connect the PID/VID to the Initialize port.
- 3 Host enumerates the PID/VID and shall enter a high-speed J state. (D+ high; D- low).
- 4 Flip the switch of the test fixture that switches the termination on. LED power and Test mode illuminate (Orange LED lit).
- 5 Click **OK** to close the Test Instructions dialog.

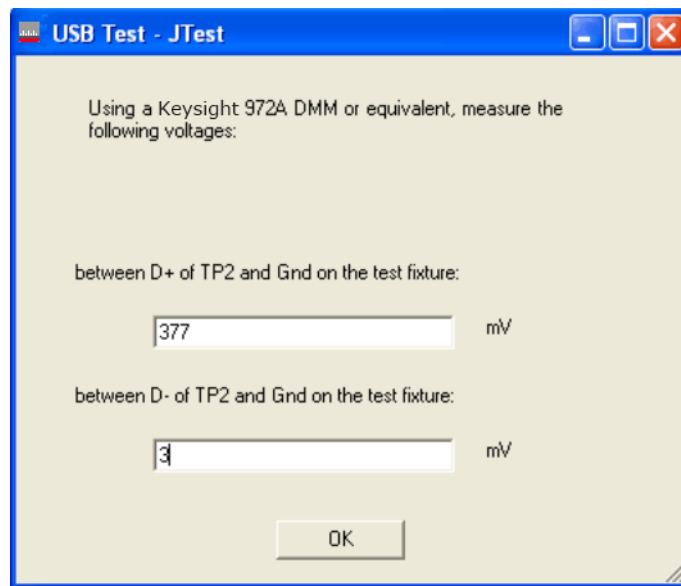
**EL_9 Undriven Voltage Host Test_K (D+) Test**

The USB automated test application will prompt you to perform these steps:

- 1 Apply power to the test fixture (E2649-26402) and put test fixture switch test mode off. LED power illuminate (Green LED), Test mode Off (Orange LED).
- 2 Connect a short USB cable from the Test port of the fixture to the Embedded Host under test.
- 3 Before connecting the PID/VID put it in the correct position by selecting Test_K.
- 4 Connect the PID/VID to the Initialize port.
- 5 Host enumerates the PID/VID and shall enter a high-speed K state. (D+ low; D- high).
- 6 Flip the switch of the test fixture that switches the termination on. LED power and Test mode illuminate (Orange LED lit).
- 7 Click **OK** to close the Test Instructions dialog.

The USB automated test application will prompt you for the following voltage measurements:

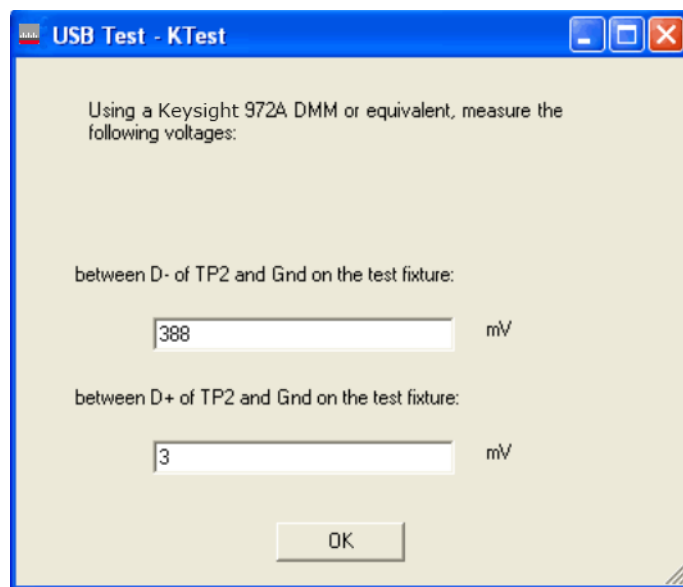

EL_9 Undriven Voltage Host SE0_NAK Test (D+/D-) Test

The USB automated test application will prompt you to perform these steps:

- 1 Apply power to the test fixture and put test fixture switch test mode off. LED power illuminate (Green LED), Test mode not (Orange LED).
- 2 Connect a short USB cable from the Test port of the fixture to the Embedded Host under test.
- 3 Before connecting the PID/VID put it in the correct position by selecting Test_SE0_NAK.
- 4 Connect the PID/VID to the Initialize port.
- 5 Host enumerates the PID/VID and shall drive an SE0 state. (D+ low; D- low)
- 6 Flip the switch of the test fixture that switches the termination on. LED power and Test mode illuminate (Orange LED lit).
- 7 Click **OK** to close the Test Instructions dialog.

The USB automated test application will prompt you for the following voltage measurements:

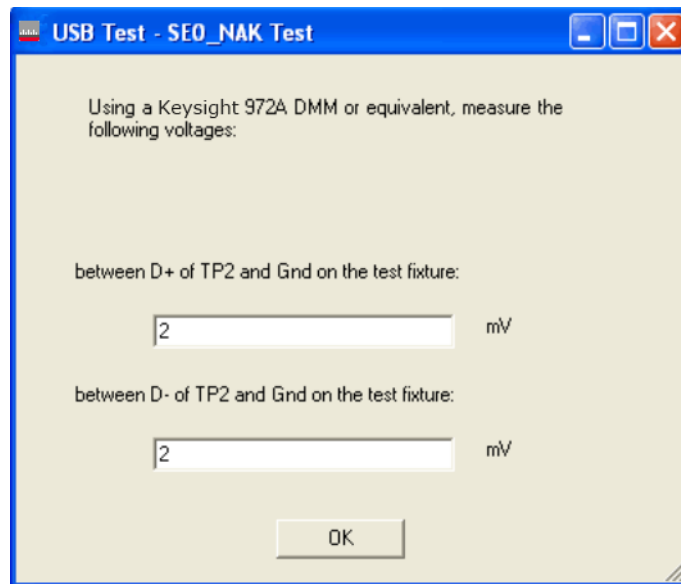

Viewing Test Results

- 1 When the Testing Complete dialog appears, click **OK**. The Results tab shows the test results.

9

Manual Testing and Measurement Using Oscilloscope

Device/Hub/Host Signal Quality Measurement	248
Packet Parameter Scope Setup for Device/Hub/Host	249
Chirp Timing Setup	253
Device/Hub/Host Suspend Timing	257
Device/Hub/Host Resume Timing	258
Device Reset Timing	259
Device/Hub Reset from Suspend Timing	260
Device/Hub Receiver Sensitivity	261
Hub Repeater Test – Downstream Facing Ports (EL_42, EL_43, EL_44, EL_45, EL_48)	265
Hub Repeater Test – Upstream Facing Port (EL_42, EL_43, EL_44, EL_45)	267
Upstream Full Speed Measurement	270
Upstream Low Speed Measurement	271
Downstream Full Speed Test	272
Downstream Low Speed	273
Inrush Current	274
Drop Test	275
Droop Test	276

Device/Hub/Host Signal Quality Measurement

Acquisition setup	Sampling Rate	20 GSa/s
	Sampling Points	262144 pts
	Horizontal time range	2 us
InfiniiSim	Turn On/ Off	Fixture embed / de-embed
Trigger	Trigger Setting	Sweep type: Triggered Trigger Type: Pulse Width Trigger On: >Time Time: 60 ns Source: Channel 1 Polarity: Negative
	Trigger Level/ Threshold	0.08 V
	Trigger holdoff	1 us

Measurement

On the oscilloscope, adjust the two vertical cursors around one test packet as shown below.

- 1 Adjust one marker to about four bit time before the sync field.
- 2 Adjust the other to about four bit time after the EOP (END OF PACKET).

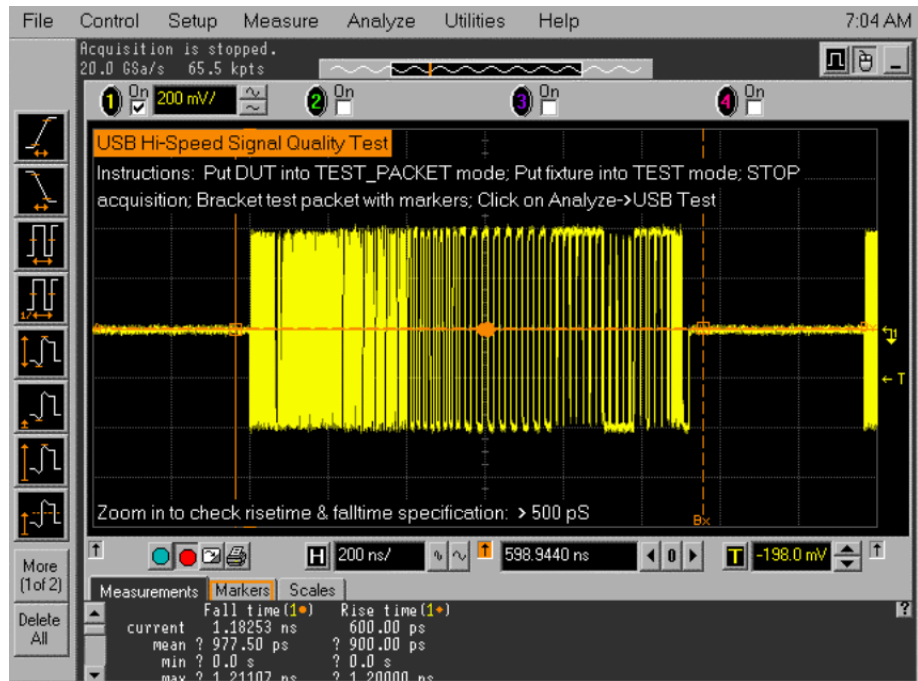

Report Value:

Pass or Fail was depends on the overall result generated by USB-IF script.

Packet Parameter Scope Setup for Device/Hub/Host

Acquisition setup	Sampling Rate	10 GSa/s
	Sampling Points	262144 pts
	Horizontal time range	10 us
Trigger	Trigger Setting	Sweep type: Triggered Trigger Type: Pattern Trigger Trigger On Logic/Time: Logic Source: Channel3 Polarity: Low Pattern Condition: Greater than 95 ns, less than 500 ns.
	Trigger Level/ Threshold	0.17 V
	Trigger holdoff	100 us

Measurement

- 1 Follow the test instruction to run HSET Tool.
- 2 The oscilloscope capture should appear as shown below. Press [STOP] on the oscilloscope to pause it from further trigger.
- 3 If the oscilloscope does not trigger on the device, adjust the trigger level down slightly (but not so low that it triggers on host SOFs), and repeat from step 1.
- 4 Measure the sync field length (number of bits) of the third (from device) packet on the oscilloscope and verify that it is 32 bits.
 - a Use [Horizontal] knobs to zoom in on the third packet, shown in the lower display.
 - b Note that Sync Field starts from the Hi-Speed idle transitions to a falling edge (due to the first zero). Count both rising and falling edges until the first two consecutive 1's and include the first 1. There must be 32 bits.
 - c It is advisable to use the markers to measure the number of bits, based on 2.08 ns/bit (480 Mbps), which is 66.6 ns for 32 bits.
- 5 Record the number in EL_21.

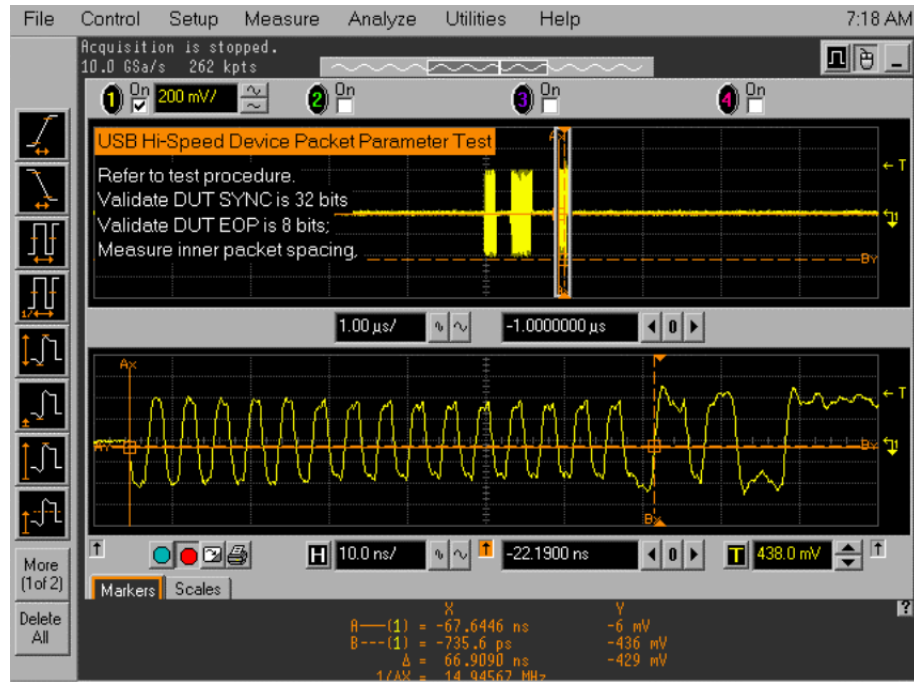

- 6 Measure the EOP (End of Packet) width (number of bits) of the third packet on the oscilloscope and verify that it is 8 bits.
 - a It is advisable to use the markers to measure the EOP pulse width to determine the number of bits, based on 2.08 ns/bit (480 Mbps), which is 16.6 ns for 8 bits.
 - b Record the result in EL_25.

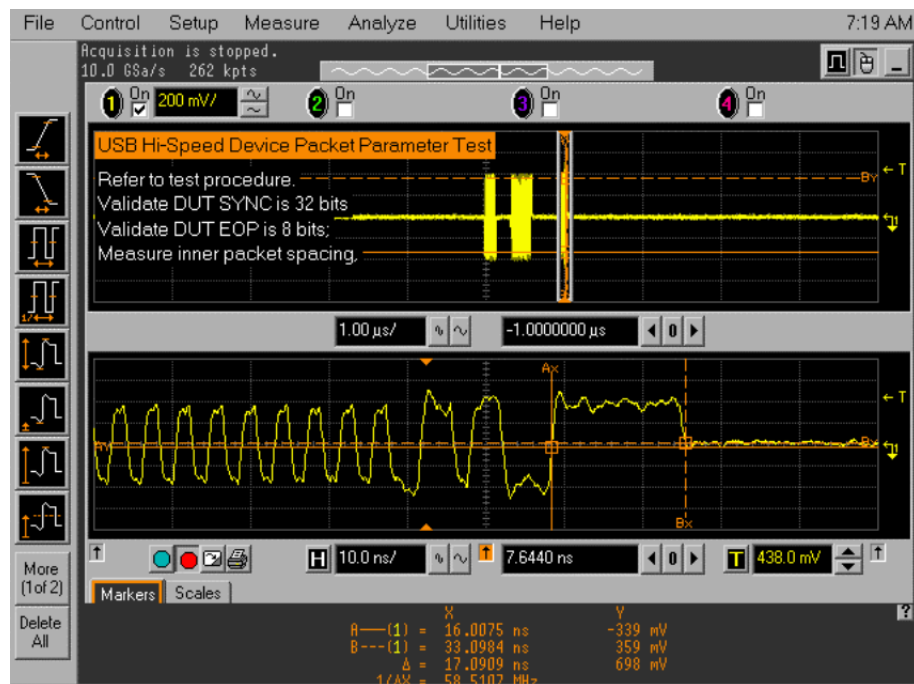

- 7 Measure the inter-packet gap between the second (from host) and the third (from device in respond to the host's) packets. The second (of lower amplitude) is from the host and the third (of higher amplitude) is a device's response.
 - a Compute the number of bits by dividing the time measure by 2.08 ns.
 - b The requirement is it must be between 8 bits (16.64 ns) and 192 bits (399.4 ns). (EL_22).
 - c Record the computed number of bits in EL_22.

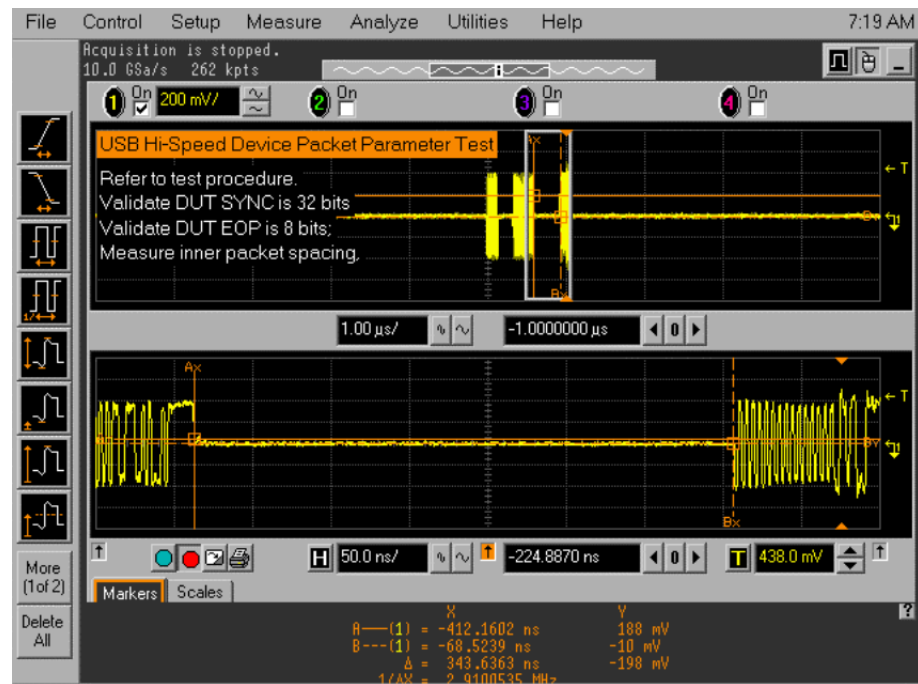

- 8 Press "RUN" on the scope.
- 9 Perform the test instruction for HSET tools. (To press "STEP" again).
- 10 You should captured the waveform shown below.

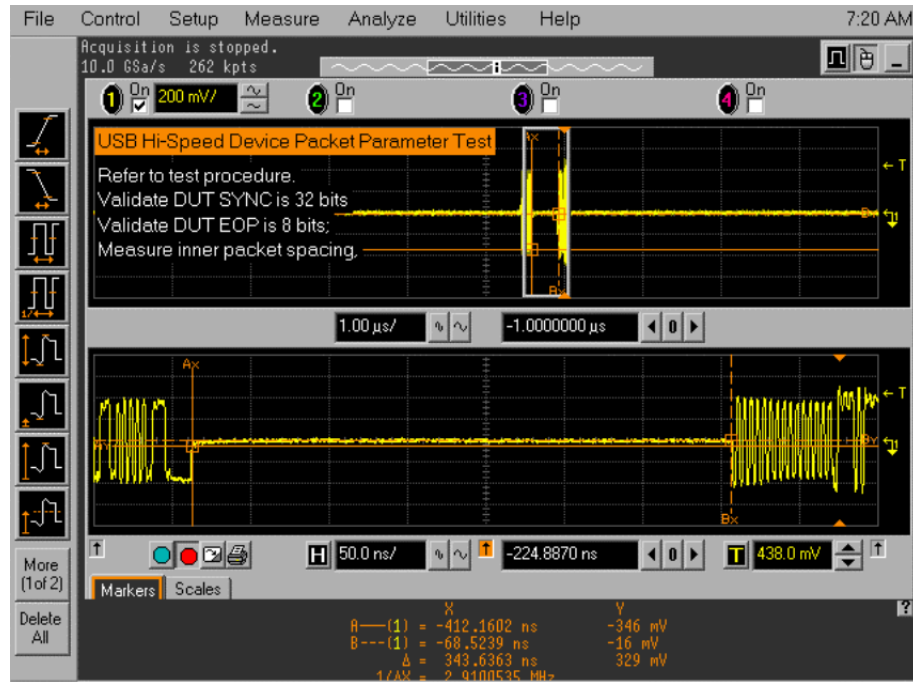

- 11 Measure the inter-packet gap between the first (from host) and the second (from device in respond to the host's) packets.
 - a The first (of lower amplitude) is from the host and the second (of higher amplitude) is a device's response.
 - b Compute the number of bits by dividing the time measure by 2.08 ns.
 - c The requirement is it must be between 8 bits (16.6 ns) and 192 bits (339 ns). (EL_22).
- 12 Record the computed number of bits in EL_22.

Chirp Timing Setup

Acquisition setup	Sampling Rate	250MSa/s
	Sampling Points	7.5M pts
	Horizontal time range	30 ms
Trigger	Trigger Setting	Sweep type: Triggered Trigger Type: Edge Source: Channel3 Polarity: Negative edge
	Trigger Level/ Threshold	1.35 V
	Trigger holdoff	100 us

Chirp Measurement

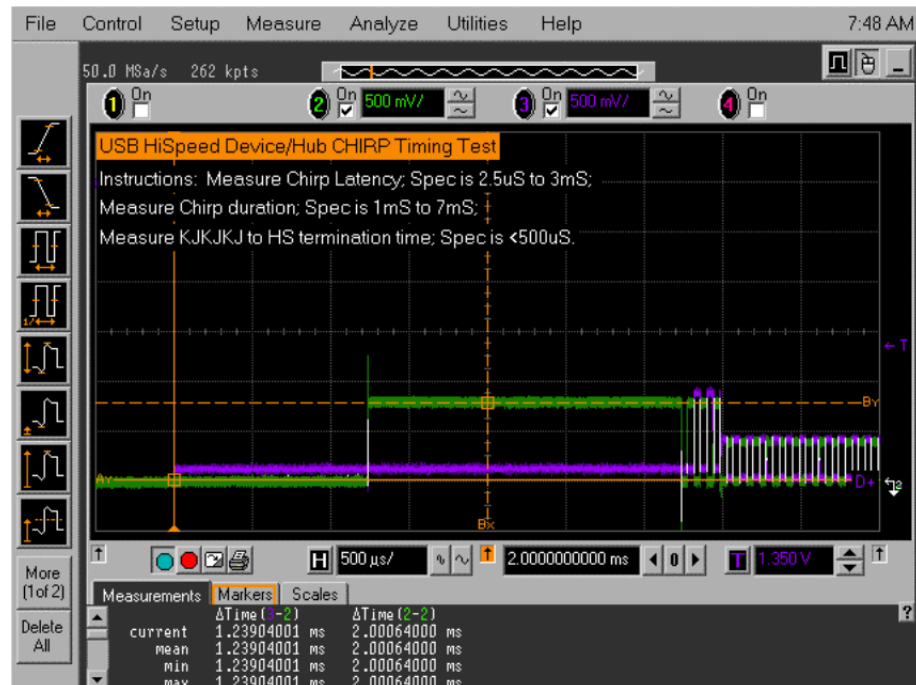

Figure 14 Measure the device's CHIRP-K latency in response to the reset from the host port

- 1 Verify this timing is between 2.5 us and 3.0 ms.
- 2 If in question of the measurement, use the markers to make this measurement manually, as shown in the following figure.
- 3 Record the result in EL_28.



Using the automatic measurement shown in Figure 14, measure the device's CHIRP-K duration.

- 1 Verify this assertion time is between 1.0 ms and 7.0 ms.
- 2 If in question about this measure, use the markers to make this measure manually, as shown in the following figure.
- 3 Record the result in EL_29.

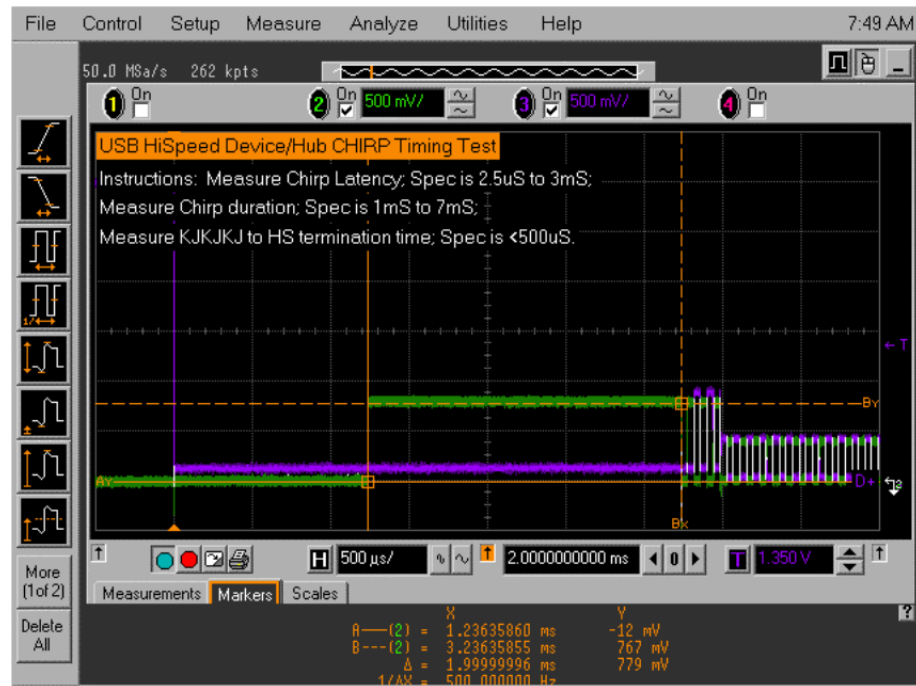

Using the markers, measure the time from the beginning of the last J in the CHIRP K-J-K-J-K-J (3 pairs of CHIRP-K-J's) to the time when the device turns on the Hi-Speed terminations, as shown in the following figure.

- 1 Following the host assertion of CHIRP K-J-K-J-K-J, the device must respond by turning on its Hi-Speed terminations. This is evident by a drop of amplitude of the alternate CHIRP-K and CHIRP-J sequence from the 800 mV nominal to the 400 mV nominal.
- 2 Verify this is less than or equal to 500 us.

3 Record the measurement in EL_31.

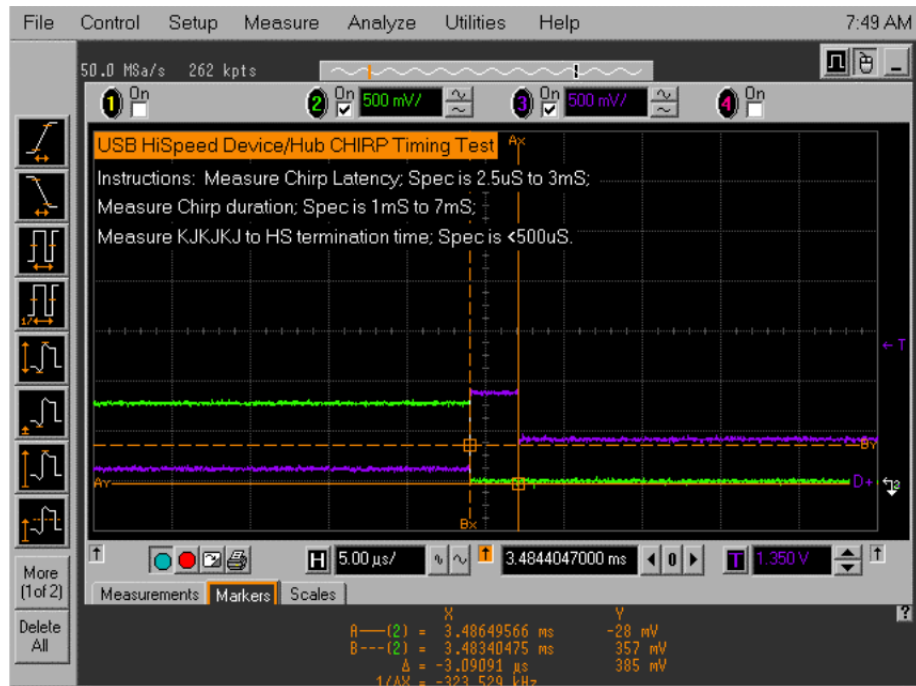

Device/Hub/Host Suspend Timing

Acquisition setup	Sampling Rate	50MSa/s
	Sampling Points	262144 pts
	Horizontal time range	4 ms
Trigger	Trigger Setting	Sweep type: Triggered Trigger Type: Edge Source: Channel 3 Polarity: Positive edge
	Trigger Level/ Threshold	2.6V
	Trigger holdoff	100 us

Suspend Timing Measurement

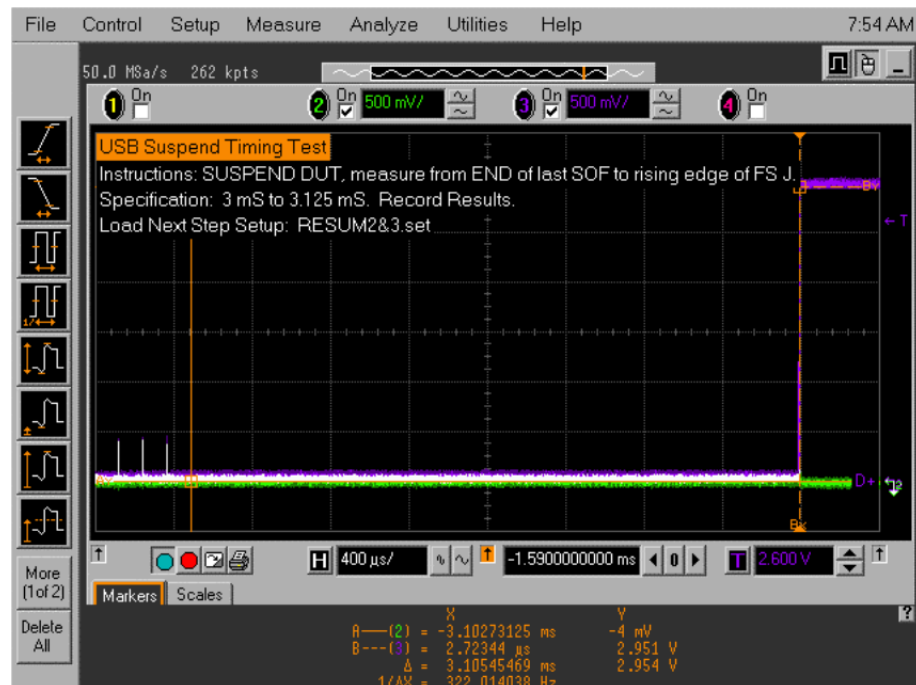

Using the oscilloscope markers, measure the time interval from the end of last SOF packet issued by the host to when the device attached its full speed pull-up resistor on D+, as shown in the previous figure.

- 1 This is the time between the END of the last SOF packet and the rising edge transition to full speed J-state.
- 2 Verify this time is between 3.000 ms and 3.125 ms.
- 3 Record the result in EL_38.

Device/Hub/Host Resume Timing

Acquisition setup	Sampling Rate	2 GSa/s
	Sampling Points	16.4M pts
	Horizontal time range	500 us
Trigger	Trigger Setting	Sweep type: Triggered Trigger Type: Edge Source: Channel 2 Polarity: Negative edge
	Trigger Level/ Threshold	1.8V
	Trigger holdoff	100 us

Resume Timing Measurement

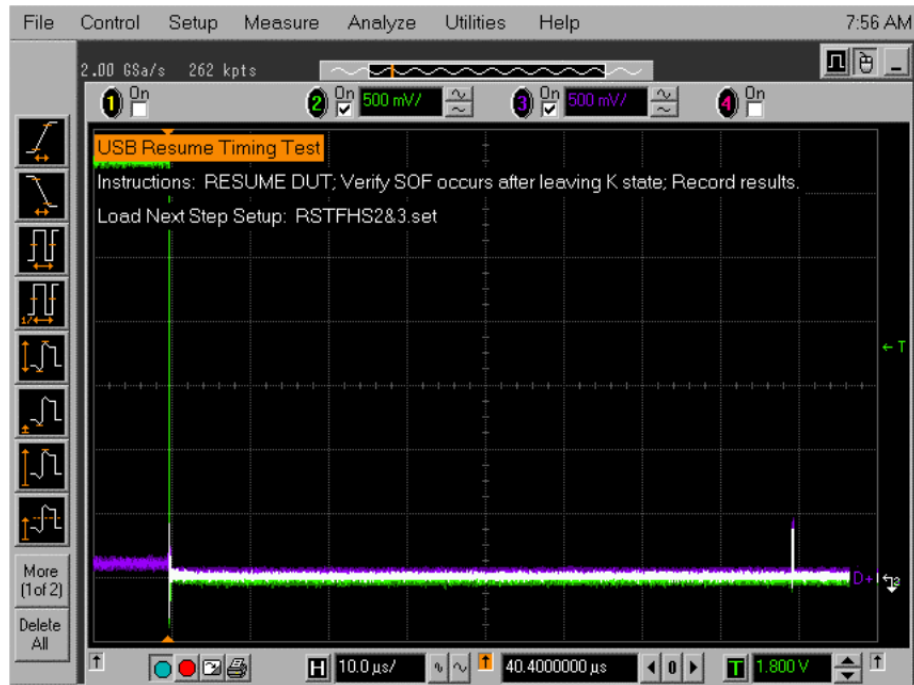

The device should resume the HS operation, which is indicated by the presence of HS SOF packets (with 400 mV nominal amplitudes) following the K state driven by the host controller, as shown in the previous figure.

- 1 Record the PASS/FAIL result in EL_40.

Device Reset Timing

Acquisition setup	Sampling Rate	25MSa/s
	Sampling Points	262144 pts
	Horizontal time range	2 us
Trigger	Trigger Setting	Sweep type: Triggered Trigger Type: Pattern Trigger Trigger On Logic/Time: Logic Source: Channel 2 Polarity: High Source: Channel3 Polarity: Low Pattern Condition: Greater than 1 us.
	Trigger Level/ Threshold	Chan2: 500 mV Chan3: 300 mV
	Trigger holdoff	100 ns

Device/Hub Reset Timing Measurement

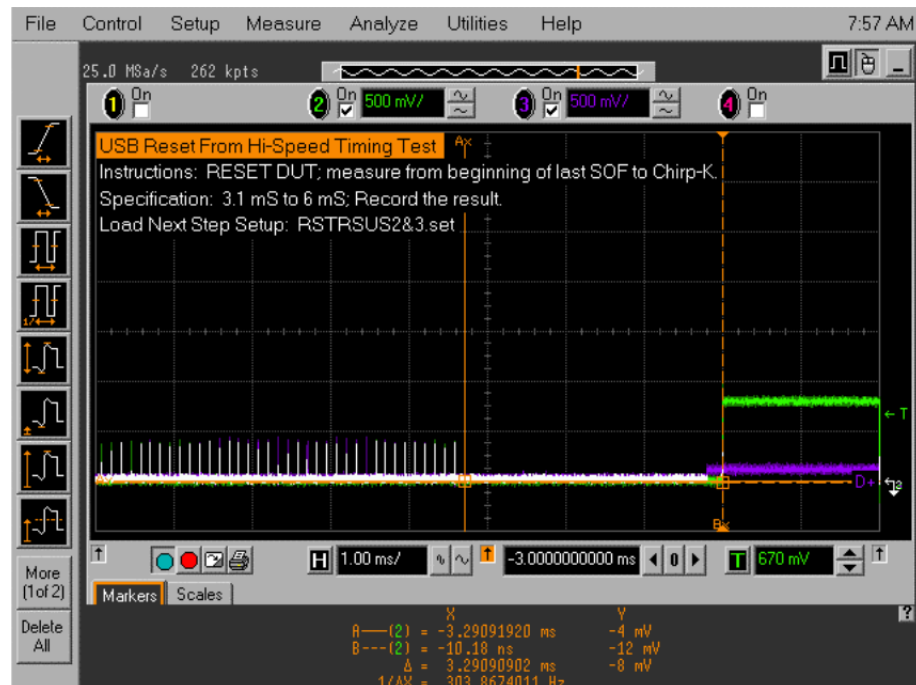

The device should transmit a CHIRP handshake following the reset.

- 1 Measure the time between the beginning of the last SOF before the reset and the start of the device CHIRP-K.
- 2 Verify this is between 3.1 ms and 6 ms.
- 3 Record the PASS/FAIL result in EL_27.

Device/Hub Reset from Suspend Timing

Acquisition setup	Sampling Rate	10 MSa/s
	Sampling Points	262144 pts
	Horizontal time range	500 us
Trigger	Trigger Setting	Sweep type: Triggered Trigger Type: Edge Source: Channel 3 Polarity: Negative edge
	Trigger Level/ Threshold	1.8 V
	Trigger holdoff	100 us

Measurement

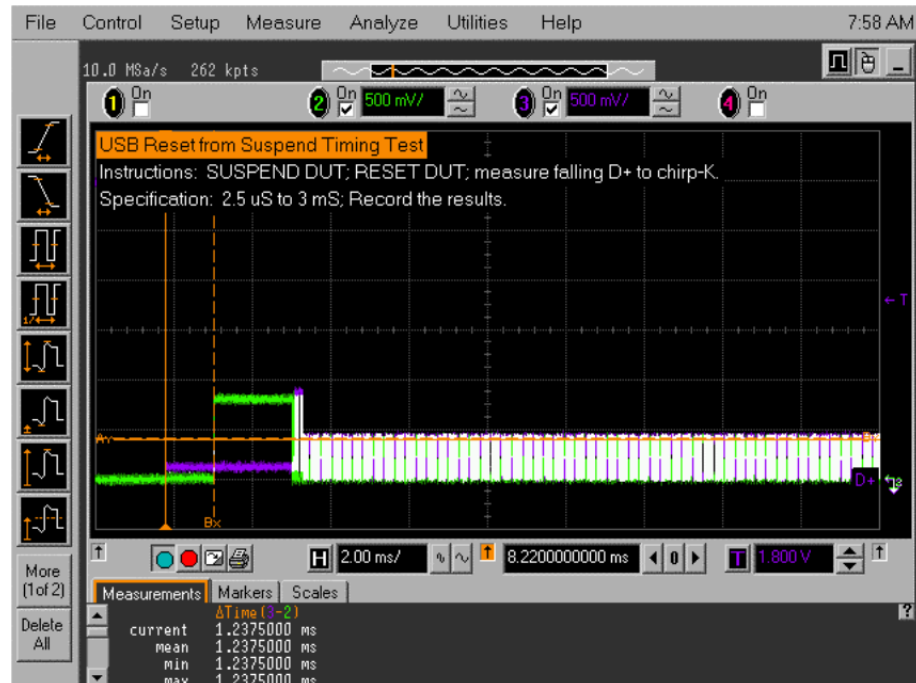

The device responds to the reset with the CHIRP-K.

- 1 Using the automatic measurement shown in the bottom left of the previous figure, measure the time between the falling edge of the D+ and the start of the device CHIRP-K.
- 2 Verify this is between 2.5 us and 3 ms.
- 3 If in question of this measurement, use the markers to manually measure.
- 4 Record the PASS/FAIL results in EL_28.

Device/Hub Receiver Sensitivity

Acquisition setup	Sampling Rate	10 GSa/s
	Sampling Points	262144 pts
	Horizontal time range	20 us
Trigger	Trigger Setting	Sweep type: Triggered Trigger Type: Pattern Trigger Trigger On Logic/Time: Logic Source: Channel 1 Polarity: Low Pattern Condition: Greater than 100 ns, less than 1.7 us
	Trigger Level/ Threshold	Chan1: 100 mV
	Trigger holdoff	1 us

Receiver Sensitivity Measurement

Generates “IN” packets (of compliant amplitude) with a 12-bit SYNC field.

Verify that all packets from the data generator are NAK'd by the port under test as in the following figure.

- 1 Record the PASS/Fail in EL_18.

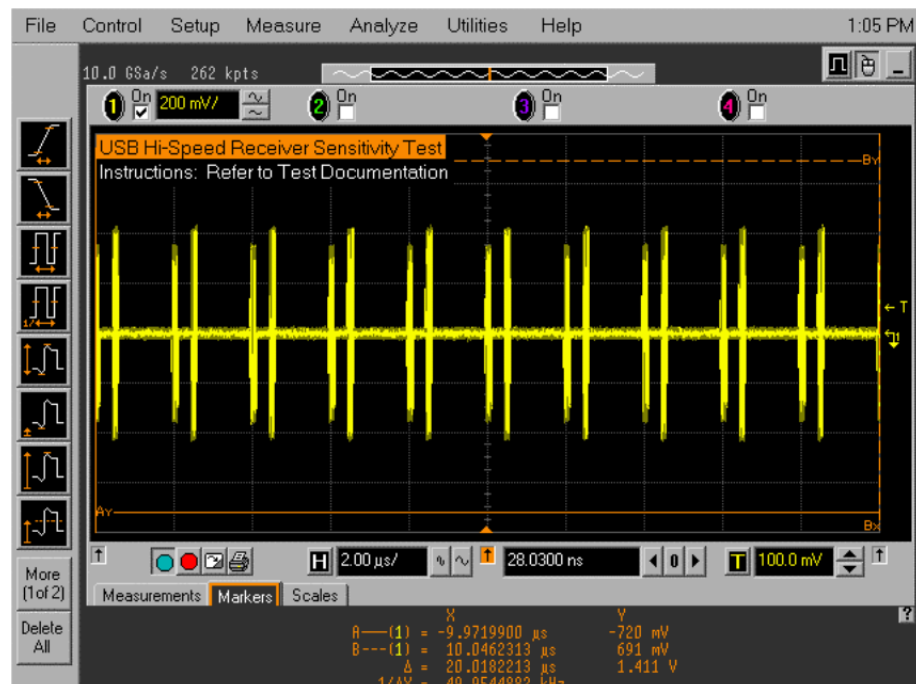

Generates “IN” packets (of compliant amplitude) with a 32-bit SYNC field as shown below.

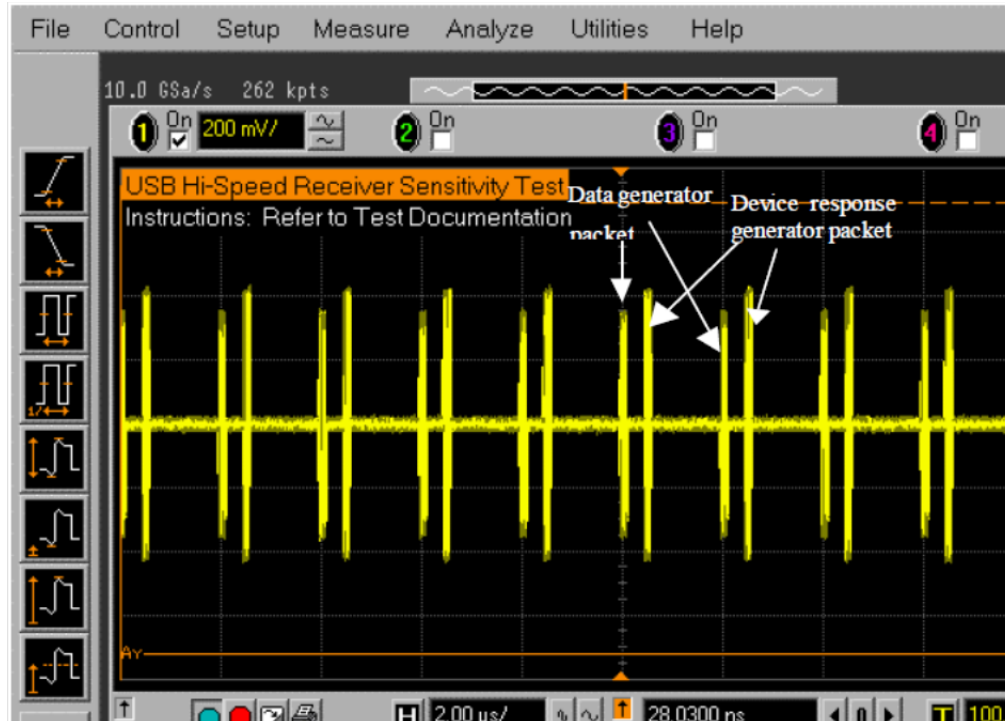

Reduce the amplitude of the data generator packets in 20 mV steps (on the generator before the attenuator) while monitoring the NAK response from the device on the oscilloscope.

- 1 The adjustment should be made to both channels such that OUTPUT1 and OUTPUT2 are matched, as indicated by the data generator readout.
- 2 Reduce the amplitude until the NAK packets begins to become intermittent.
- 3 At this point, increase the amplitude such that the NAK packet is not intermittent.
- 4 This is just above the minimum receiver sensitivity levels before squelch.

Measure the Zero to Positive Peak and Negative Peak of the packet from the data.

- 1 First, use the oscilloscope mouse to draw the zoom box around the data generator packet by pressing the “left” button and dragging the mouse.
- 2 Zoom in the waveform by clicking inside the “Zoom Box”.
- 3 Repeat this step until the packet becomes adequate size for the measurement.

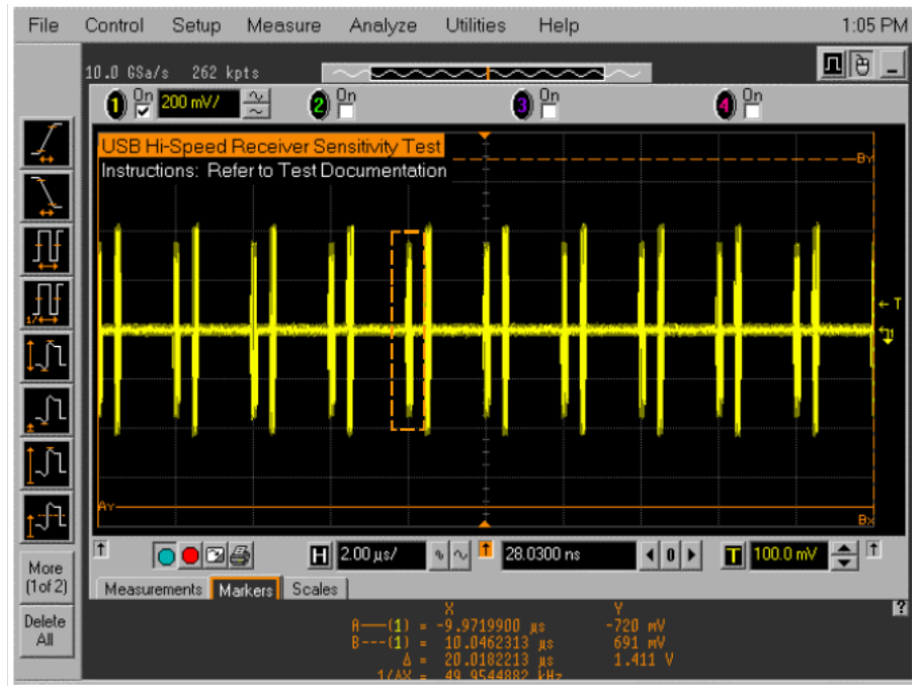

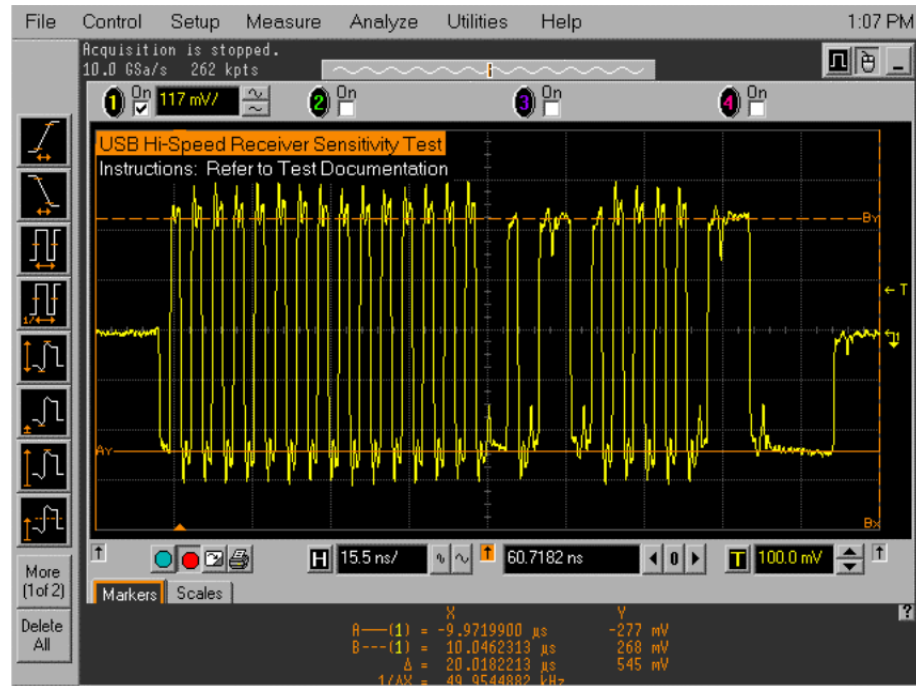

Using the oscilloscope markers, measure the packet amplitude

- 1 The markers are moved by grabbing and dragging them with the mouse pointer.
- 2 Drag [By] to the Positive Peak
- 3 Drag [Ay] to the Negative Peak.
- 4 The peak should be taken at the plateaus of the wider pulses to avoid inflated reading due to overshoots.
- 5 Read out the [Ay] and [By] values and record the measurement in EL_17
- 6 As long as the receiver continues to NAK the data generator packet above ± 150 mV, it is considered a PASS.
- 7 Record PASS/FAIL in EL_17.

Click “right” mouse button in the main oscilloscope screen with no waveform. From the menu, select “Undo Zoom”.

- 1 Now further reduce the amplitude of the packet from the data generator in small steps.
- 2 Maintain the balance between OUTPUT1 and OUTPUT2 until the receiver just ceases to respond with a NAK.
- 3 This is the squelch level of the receiver.

Measure the Zero to Positive Peak and Negative Peak of the packet from the data generator using the method described in steps 14 and 15.

- 1 Record the measurement in EL_16.
- 2 As long as the receiver ceases to NAK the data generator packet below ± 100 mV, it is considered a PASS.
- 3 Record PASS/FAIL in EL_16.

Hub Repeater Test – Downstream Facing Ports (EL_42, EL_43, EL_44, EL_45, EL_48)

Acquisition setup	Sampling Rate	10 GSa/s
	Sampling Points	262144 pts
	Horizontal time range	500 ns
Trigger	Trigger Setting	Sweep type: Triggered Trigger Type: Edge Source: Channel 1 Polarity: Positive edge
	Trigger Level/ Threshold	-118.2 mV
	Trigger holdoff	100 us



Measure the delay between the start of packet between the hub's upstream facing port (Channel 1) and the hub's down stream facing port under test (Channel 4) using the automatic measurement shown in .

- 1 This is the delay of the SOF packet through the hub.
- 2 Verify this is no more than 79 ns (36 bits plus 4 ns).
- 3 Record the result in EL_48.

Count the number of bits in the sync field on Channel 4.

- 1 Use the Horizontal knobs on the oscilloscope to zoom into the signal of interest.
- 2 Each falling or rising edges counts as one bit (consecutive zeros in NRZI format), up to and include the first no transition (due to the first one that follows the consecutive zeros in NRZI format).
- 3 Refer to the lower trace (Ch 4). In this case, the downstream SOF (Ch 4) only has 29 bits in the sync field because it truncates 3 bits from the 32 bits total on the upstream SOF (Ch 1). Determine the number of sync bit truncated by the hub.
- 4 Record the result into EL_42.

Verify also that the sync field in Channel 4 is not corrupted, when compared to that in Channel 1 except the truncation of consecutive zeros.

- 1 Record the result in EL_43.

Using the oscilloscope markers, measure the time of the EOP width of the packet in Channel 1.

- 1 Measure the time of the EOP width of the packet in Channel 4.
- 2 Determine the number of bits of each by dividing the measurement by 2.08 ns.
- 3 Verify the number of bits in Channel 4 does not have 4 more bits (EOP dribble) than that in Channel 1 (which should be 40 bits).
- 4 Record the result in EL_44.

Verify also that the EOP in Channel 4 is not corrupted.

- 1 Record the result in EL_45.

Hub Repeater Test – Upstream Facing Port (EL_42, EL_43, EL_44, EL_45)

Acquisition setup	Sampling Rate	10 GSa/s
	Sampling Points	262144 pts
	Horizontal time range	2 us
Trigger	Trigger Setting	Sweep type: Triggered Trigger Type: Pattern Trigger Trigger On Logic/Time: Logic Source: Channel 4 Polarity: Low Pattern Condition: Greater than 150 ns, less than 500 ns.
	Trigger Level/ Threshold	0.17 V
	Trigger holdoff	100 us



Count the number of bits in the sync field on the third packet in Channel 1.

- 1 Use the oscilloscope Horizontal Knobs to zoom in on the signal of interest.
- 2 Each falling or rising edges counts as one bit (consecutive zeros in NRZI format), up to and include the first no transition (due to the first one that follows the consecutive zeros in NRZI format).
- 3 Refer to the top trace (Ch 1) in the following figure that has 29 bits in the sync field for example.
- 4 Verify the truncation of the sync field is no more than 4 bits (the number of sync bits in channel 1 should not be more than 4 bit less than that in channel 4.
- 5 Record the result in EL_42.

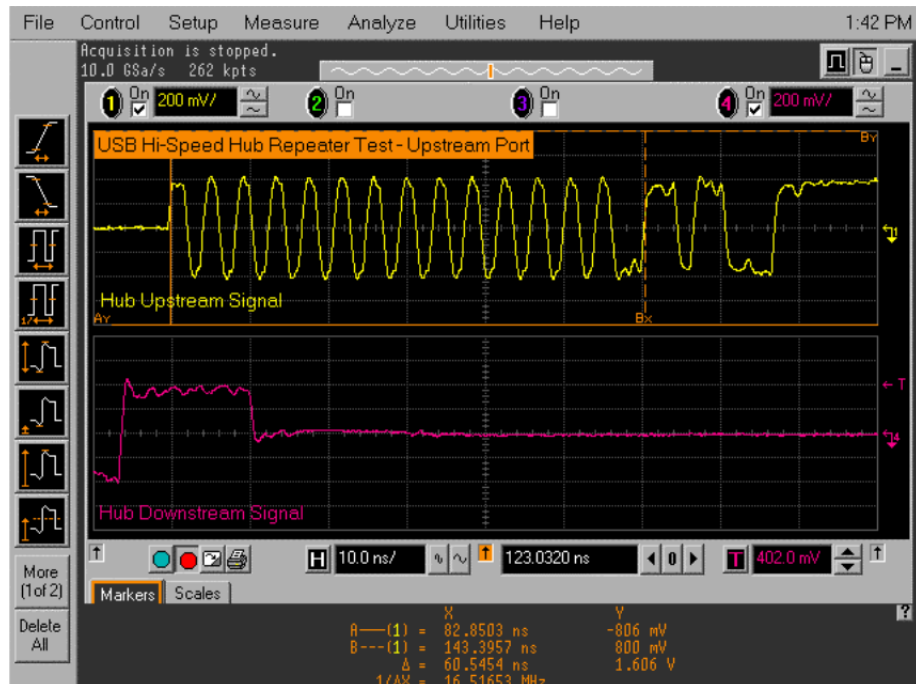

Measure the time of the EOP width of the packet in Channel 1.

- 1 Measure the time of the EOP width of the packet in Channel 4. Refer to the following figure for reference.
- 2 Determine the number of bits of each by dividing the measurement by 2.08 ns.
- 3 Verify the number of bits in Channel 1 is no more than 4 bits than that in Channel 4 (which should be 8 bits).
- 4 Record the result in EL_44.

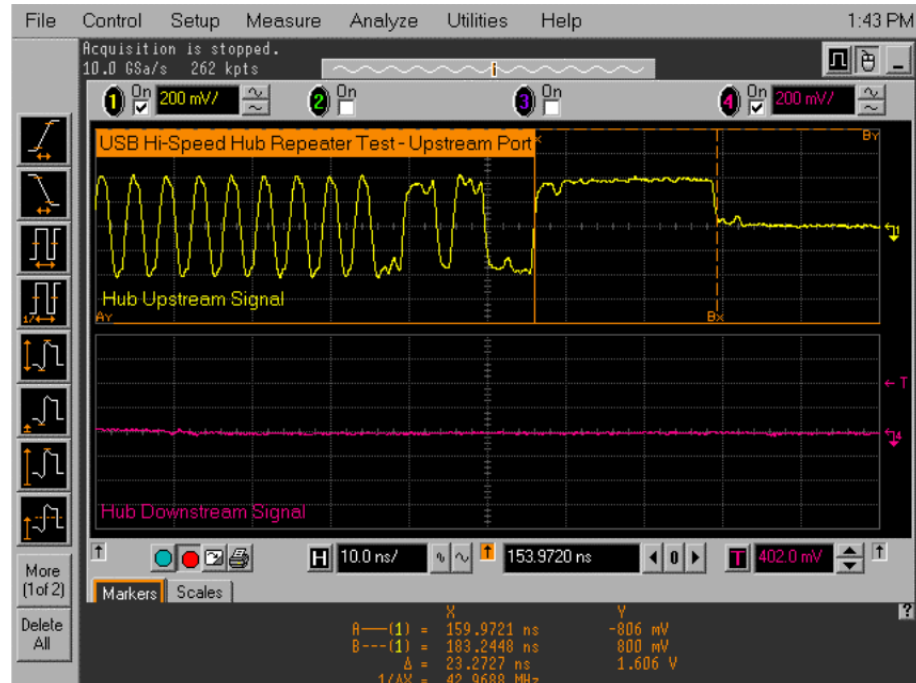

Verify also that the EOP in Channel 4 is not corrupted.

- 1 Record the result in EL_45.

Upstream Full Speed Measurement

Acquisition setup	Sampling Rate	4 GSa/s
	Sampling Points	32768 pts
	Horizontal time range	5 μ s
Trigger	Trigger Setting	Sweep type: Triggered Trigger Type: Pattern Trigger On Logic: Logic 0 Source: Channel 2 and Channel 3 Range condition: Greater than 500 ns Trigger Points: Pattern exits
	Trigger Level/ Threshold	0.8 V (for channel 2 and channel 3)
	Trigger holdoff	100 ns



Measurement will be done using the USBIF-dll script.

Upstream Low Speed Measurement

Acquisition setup	Sampling Rate	4 GSa/s
	Sampling Points	262144 pts
	Horizontal time range	50 us
Trigger	Trigger Setting	Sweep type: Triggered Trigger Type: Pattern Trigger On Logic: Logic 0 Source: Channel 2 and channel 3 Trigger On Logic: Logic 1 Source: Channel 1 Range condition: Greater than 100 ns Trigger Points: Pattern exits
	Trigger Level/ Threshold	0.8 V (for channel 2 and channel 3) 1.5 V for channel 1
	Trigger holdoff	100 ns



Waveform will be saved and processed by USBIF dll script.

Downstream Full Speed Test

Acquisition setup	Sampling Rate	4 GSa/s
	Sampling Points	32768 pts
	Horizontal time range	1 us
Trigger	Trigger Setting	Sweep type: Triggered Trigger Type: Pattern Trigger On Logic: Logic 1 Source: Channel 2 Trigger On Logic: Logic 0 Source: Channel 3 Range condition: Greater than 95 ns Trigger Points: Pattern exits
	Trigger Level/ Threshold	1.66 V (for channel 2 and channel 3)
	Trigger holdoff	10 us

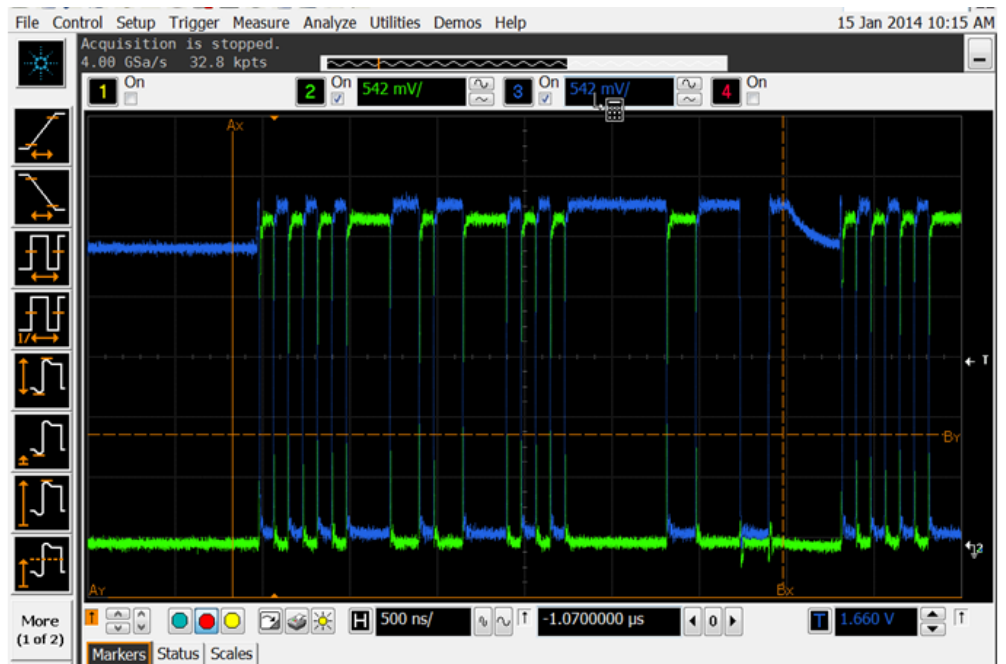

Captured waveform will be saved for USBIF script processing.

Downstream Low Speed

Acquisition setup	Sampling Rate	4 GSa/s
	Sampling Points	500000 pts
	Horizontal time range	10 μ s
Trigger	Trigger Setting	Sweep type: Triggered Trigger Type: Edge Source: Channel 3 Transition: Positive Edge
	Trigger Level/ Threshold	1.66 V (channel 3)
	Trigger holdoff	100 ns

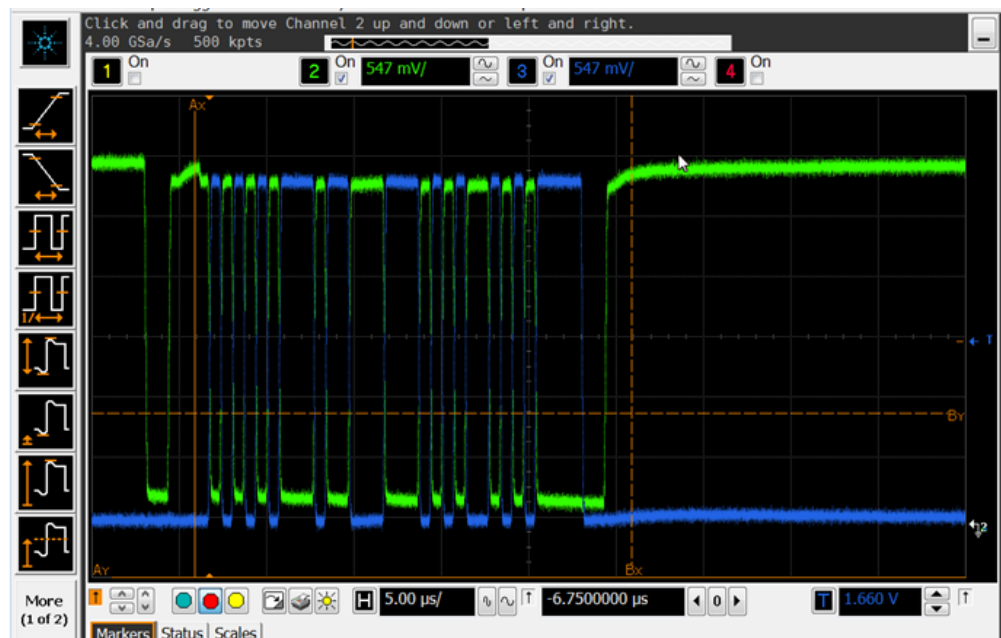

Captured waveform will be saved for USBIF script processing.

Inrush Current

Acquisition setup	Sampling Rate	1MSa/s
	Sampling Points	262144 pts
	Horizontal time range	15ms
Trigger	Trigger Setting	Sweep type: Single Trigger Type: Edge Source: Channel 4 Transition: Positive Edge
	Trigger Level/ Threshold	160 mA (channel 4)
	Trigger holdoff	100 ns



Captured waveform will be saved for USBIF script processing.

Drop Test

Acquisition setup	Sampling Rate	Auto
	Sampling Points	Auto
	Horizontal time range	100 ns
Trigger	Trigger Setting	Sweep type: Auto Trigger Type: Edge Source: Channel 1 Transition: Positive Edge
	Trigger Level/ Threshold	0 V (channel 1)
	Trigger holdoff	100 ns

Place marker Ay at 0 V and Bx at the measured signal, make the measurement for Vno_load and Vload.

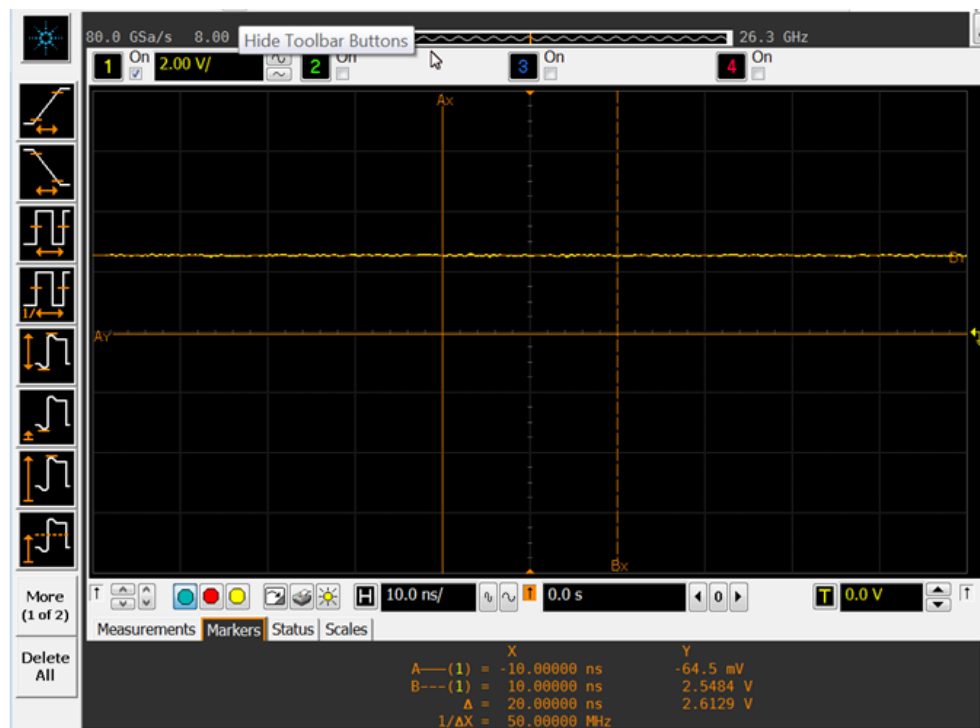
**NOTE**

Due to the voltage divider circuit on the droop-drop board, please ensure the measurement above been multiplied by 2 to get the end result.

Droop Test

Acquisition setup	Sampling Rate	Auto
	Sampling Points	16384 pts
	Horizontal time range	300 us
	Averaging	on
Trigger	Trigger Setting	Sweep type: Triggered Trigger Type: Edge Source: Channel 1 Transition: Positive Edge
	Trigger Level/ Threshold	1 V (channel 2)
	Trigger holdoff	100 ns

Turn on External scaling with Gain as 0.5.

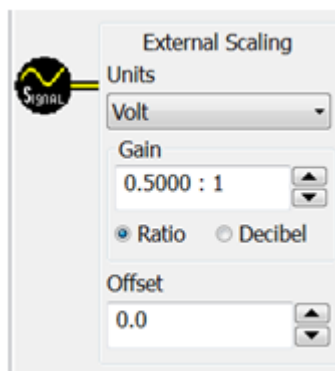

Measurement:

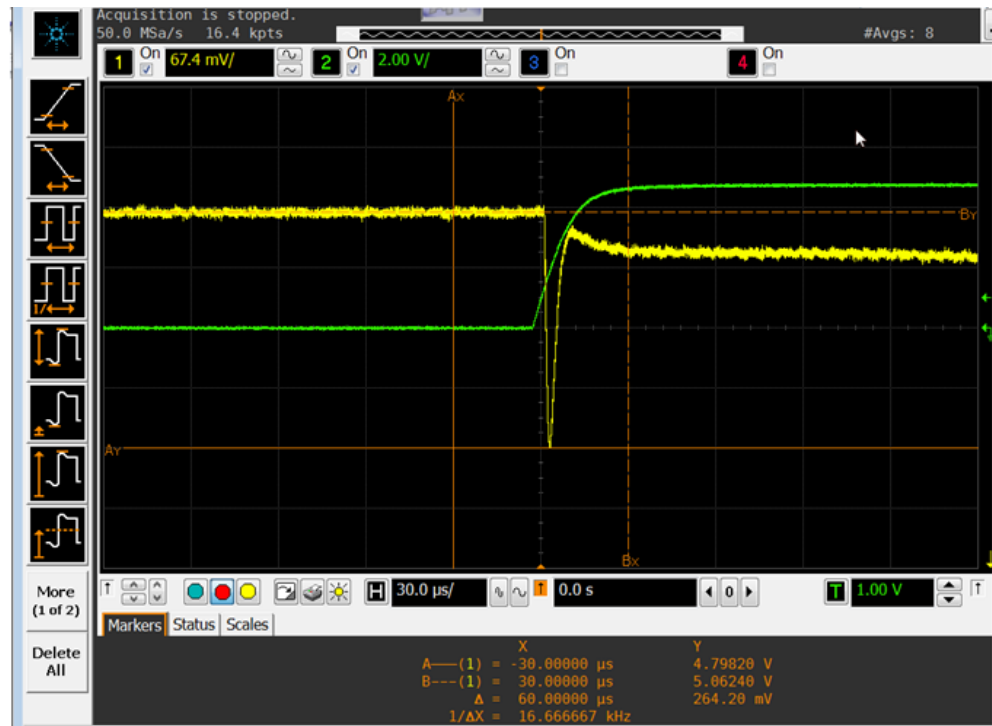

Place Market at channel 1 as shown above.

The difference between Vtop and Vbase was the final result for Droop Test.

Index

Numerics

100 mA load board schematic, [183](#)
10073C miniature passive probes, [30](#)
1156A probes, [30](#)
500 mA load board schematic, [183](#)
81134A pulse generator, [107](#)
81134A/81130A Instrument Address configuration option, [71](#), [107](#)
82357A GPIB-USB converter, [107](#)
82357A USB/GPIB interface, [25](#)

C

cables, [25](#)
calibrate probes, [31](#)
calibration, [30](#)
common ground reference, [31](#)
compensate passive probes, [30](#)
computer, high-speed electrical test bed, [27](#)
configure, [33](#)
connect, [33](#)

D

debug mode, [181](#)
device CHIRP timing, [53](#)
device hi-speed signal quality test, [39](#)
device hi-speed tests, [37](#)
device packet parameters, [46](#)
device receiver sensitivity, [70](#)
device suspend/resume/reset timing, [56](#)
device test J/K, SEO_NAK, [64](#)
differential probe, [30](#)
digital signal generator, [25](#), [31](#)
droop/drop test, [184](#)

E

E2697A adapters, [30](#)
EHCI driver stack, [27](#)
electrical test bed computer, [27](#)
equipment required, [24](#)
equipment, setting up, [30](#)

G

ground reference, common, [31](#)

H

high-speed electrical test bed computer, [27](#)
High-Speed Electrical Test Tool Kit software, [27](#)
host CHIRP timing, [165](#)
host controller packet parameters, [157](#)
host disconnect detect, [165](#)
host downstream signal quality test, [191](#)
host hi-speed electrical tests, [149](#)
host hi-speed signal quality, [151](#)
host suspend/resume timing, [169](#)
host test J/K, SEO_NAK, [174](#)
HTML report, [33](#)
hub CHIRP timing - upstream facing port, [124](#)
hub disconnect detect, [92](#)
hub downstream signal quality test, [197](#)
hub hi-speed signal quality test - downstream facing ports, [83](#)
hub hi-speed signal quality test - upstream facing ports, [77](#)
hub hi-speed tests, [75](#)
hub jitter test - downstream facing ports, [87](#)
hub packet parameters - upstream facing port, [92](#)
hub receiver sensitivity - upstream facing port, [105](#)
hub repeater test - downstream facing port, [115](#)
hub repeater test - upstream facing port, [119](#)
hub suspend/resume/reset timing - upstream facing port, [128](#)
hub test J/K, SEO_NAK - downstream facing port, [142](#)
hub test J/K, SEO_NAK - upstream facing port, [135](#)

I

identify test environment, [33](#)
in this book, [5](#)
inrush current test, [187](#)
installing the software, [18](#)

L

license key, installing, [19](#)

load board, [28](#)

M

memory upgrade option, [24](#), [38](#), [75](#), [149](#)
monitor, optional, [30](#)
multimeter, [25](#)

N

N5416A USB 2.0 Compliance Test Option, [4](#), [24](#)

O

On-The-Go electrical tests, [219](#), [247](#)
optional computer monitor, [30](#)
oscilloscope required, [24](#)
oscilloscope, software, and accessories, [24](#)

P

passive probes, compensating, [30](#)
probes, calibrating, [31](#)
pulse generator's SICL address, [71](#), [107](#)
pulse/pattern generator, [25](#)

R

report, [33](#)
required equipment and software, [24](#)
results, [33](#)
run tests, [33](#)
running tests, [35](#)

S

select tests, [33](#)
SICL address, pulse generator, [71](#), [107](#)
software, installing, [18](#)
SQiDD board, [28](#)
starting the USB automated test application, [32](#)

T

test bed computer, high-speed electrical, [27](#)
test fixtures, USB electrical, [28](#)

tests, running, [35](#)
troubleshooting hi-speed test
failures, [181](#)

U

upstream signal quality test, [203](#)
USB electrical test fixtures, [28](#)
USB Implementers Forum web site, [5](#)
USBHSET software, [27](#)

W

web site, USB Implementers Forum, [5](#)