

Keysight 2-Port and 4-Port PNA-X Network Analyzer

N5244A - 10 MHz to 43.5 GHz
N5245A - 10 MHz to 50.0 GHz
with Option H29

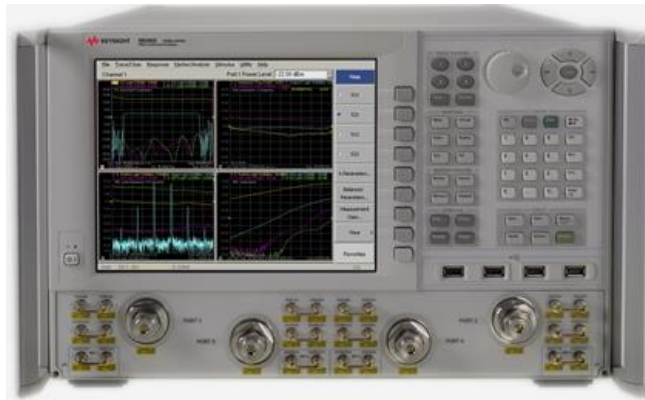

Data Sheet and
Technical
Specifications

Documentation Warranty

THE MATERIAL CONTAINED IN THIS DOCUMENT IS PROVIDED "AS IS," AND IS SUBJECT TO BEING CHANGED, WITHOUT NOTICE, IN FUTURE EDITIONS. FURTHER, TO THE MAXIMUM EXTENT PERMITTED BY APPLICABLE LAW, KEYSIGHT DISCLAIMS ALL WARRANTIES, EITHER EXPRESS OR IMPLIED WITH REGARD TO THIS MANUAL AND ANY INFORMATION CONTAINED HEREIN, INCLUDING BUT NOT LIMITED TO THE IMPLIED WARRANTIES OF MERCHANTABILITY AND FITNESS FOR A PARTICULAR PURPOSE. KEYSIGHT SHALL NOT BE LIABLE FOR ERRORS OR FOR INCIDENTAL OR CONSEQUENTIAL DAMAGES IN CONNECTION WITH THE FURNISHING, USE, OR PERFORMANCE OF THIS DOCUMENT OR ANY INFORMATION CONTAINED HEREIN. SHOULD KEYSIGHT AND THE USER HAVE A SEPARATE WRITTEN AGREEMENT WITH WARRANTY TERMS COVERING THE MATERIAL IN THIS DOCUMENT THAT CONFLICT WITH THESE TERMS, THE WARRANTY TERMS IN THE SEPARATE AGREEMENT WILL CONTROL.

DFARS/Restricted Rights Notice

If software is for use in the performance of a U.S. Government prime contract or subcontract, Software is delivered and licensed as "Commercial computer software" as defined in DFAR 252.227-7014 (June 1995), or as a "commercial item" as defined in FAR 2.101(a) or as "Restricted computer software" as defined in FAR 52.227-19 (June 1987) or any equivalent agency regulation or contract clause. Use, duplication or disclosure of Software is subject to Keysight Technologies' standard commercial license terms, and non-DOD Departments and Agencies of the U.S. Government will receive no greater than Restricted Rights as defined in FAR 52.227-19(c)(1-2) (June 1987). U.S. Government users will receive no greater than Limited Rights as defined in FAR 52.227-14 (June 1987) or DFAR 252.227-7015 (b)(2) (November 1995), as applicable in any technical data.

Specifications: N5244A and N5245A Option H29.....	5
Corrected System Performance with 3.5mm Connectors	5
Table 1. 85056A Calibration Kit	5
Specifications: N5244A and N5245A Option H29 (continued).....	6
Specifications: N5244A and N5245A Option H29 (continued).....	7
Specifications: N5244A and N5245A Option H29 (continued).....	8
Table 2. N4693A 2-Port Electronic Calibration Module	9
Specifications: N5244A and N5245A Option H29 (continued).....	10
Specifications: N5244A and N5245A Option H29 (continued).....	12
Uncorrected System Performance, N5244A and N5245A Option H29	13
Noise Error Terms: N5244A and N5245A Option H29.....	13
Table 3. Noise State Directivity, Port 1 and Port 2 ¹ (dB).....	13
Table 4. Noise State Load Match, Port 1 ¹ (dB)	14
Table 5. Noise State Load Match, Port 2 ¹ (dB).....	15
Table 6. Noise State Reflection Tracking (S_{11} and S_{22}), Min/Max (dB)	16
Table 7. Noise State Transmission Tracking, Min/Max (dB).....	16
Table 8. Noise State Source Match, Port 1 ¹ (dB)	17
Table 9. Noise State Source Match, Port 2 ¹ (dB)	17
Test Port Input: Option H29.....	18
Table 10. Receiver Noise Figure, Port 2 (dB)	18
Table 11. Noise Jitter ^{1,2} (dB)	19
Table 12. Noise Receiver Linearity (dB)	20
Table 13. Noise Receiver Input Range	21
Test Port Output: Option H29.....	22
Table 14. Max Leveled Power, Port 1 Filtered Mode (dBm)	22
Table 15. Max Leveled Power, Port 1 High Power Mode (dBm).....	23
Table 16. Max Leveled Power, Port 1 Source 1, Combine Mode, Filtered Mode (dBm)	24
Table 17. Max Leveled Power, Port 1 Source 1, Combine Mode, High Power Mode (dBm)	25
Table 18. Max Leveled Power, Port 1 Source 2, Combine Mode, Filtered Mode (dBm)	26
Table 19. Max Leveled Power, Port 1 Source 2, Combine Mode, High Power Mode (dBm)	27
Table 20. Max Leveled Power, Port 2 (dBm).....	28
Test Set Block Diagrams.....	29
Figure 1. 4-Port N5244A and N5245A Option 423/H29	29
Receiver Block Diagram	29

This is the technical specifications for the N5244A and N5245A PNA-X network analyzer with option H29.

Option H29, adds 26.5 GHz low-noise receivers to N5244A/45A for fully-corrected noise figure measurements of amplifiers, frequency converters, and mixers, utilizing source-correction technique (requires option 400, 419 and 423). See the block diagram.

Option 400, 4-port standard test set (includes twelve front-panel access loops), power range, and an internal second source (Option 080 recommended).

Option 419, adds 4-port extended power range, source and receiver attenuators, and bias-tees (requires Option 400).

Option 423, adds an internal combiner, and mechanical switches to the 4-port analyzer (requires Option 400, 419, and 080).

Notes

In noise mode, the S-parameter measurement performance above 26.5 GHz is degraded due to the 26.5 GHz noise coupler in the port 2 source path (shown in green on the block diagram on page 30). Noise measurements are not specified above 26.5GHz.

This document provides technical specifications for the 85056A calibration kit, and the N4693A 2-Port ECal module. Please download our free Uncertainty Calculator from http://www.keysight.com/find/na_calculator to generate the curves for your calibration kit and PNA setup.

Definitions

All specifications and characteristics apply over a 25 °C ±5 °C range (unless otherwise stated) and 90 minutes after the instrument has been turned on.

Specification (spec.): Warranted performance. Specifications include guardbands to account for the expected statistical performance distribution, measurement uncertainties, and changes in performance due to environmental conditions.

Characteristic (char.): A performance parameter that the product is expected to meet before it leaves the factory, but that is not verified in the field and is not covered by the product warranty. A characteristic includes the same guardbands as a specification.

Typical (typ.): Expected performance of an average unit which does not include guardbands. It is not covered by the product warranty.

Nominal (nom.): A general, descriptive term that does not imply a level of performance. It is not covered by the product warranty.

Calibration: The process of measuring known standards to characterize a network analyzer's systematic (repeatable) errors.

Corrected (residual): Indicates performance after error correction (calibration). It is determined by the quality of calibration standards and how well "known" they are, plus system repeatability, stability, and noise.

Uncorrected (raw): Indicates instrument performance without error correction. The uncorrected performance affects the stability of a calibration.

Standard: When referring to the analyzer, this includes no options unless noted otherwise.

Specifications: N5244A and N5245A Option H29

General specifications apply to Option H29 with the port 1 noise tuner switch set to the internal position except as stated below. By default, the switch is set to the external position to ensure functional compatibility with existing PNA instruments. Refer to the Help System topic “Noise Figure Application” for information on setting the switch position.

Corrected System Performance with 3.5mm Connectors

Note: For any S_{ii} reflection measurement:

- $S_{jj} = 0$.

For any S_{ij} transmission measurement:

- $S_{ji} = S_{ij}$ when $S_{ij} \leq 1$
- $S_{ji} = 1/S_{ij}$ when $S_{ij} > 1$
- $S_{kk} = 0$ for all k

Table 1. 85056A Calibration Kit

N5244A and N5245A Option H29

Applies to the N5244A and N5245A analyzer with Option H29, an 85056A (2.4mm) calibration kit, an 85133F flexible test port cable set, and a full 2-port calibration. S-parameter measurements were made with the analyzer in the noise figure configuration. Environmental temperature $23^\circ \pm 3^\circ \text{C}$, with $< 1^\circ \text{C}$ deviation from calibration temperature.

Description	Specification (dB)					
	10 MHz to 45 MHz	45 MHz to 2 GHz	2 GHz to 20 GHz	20 GHz to 26.5 GHz	26.5 GHz to 40 GHz	40 GHz to 50 GHz
Directivity	42	42	42	38	38	36
Source Match	41	41	38	33	33	31
Load Match	42	42	41	37	37	35
Reflection Tracking ¹						
Mag	± 0.001	± 0.001	± 0.008	± 0.020	± 0.020	± 0.027
Phase (°)	± 0.009	± 0.009	± 0.054	± 0.133	± 0.133	± 0.180
S_{21} Transmission Tracking ¹						
Mag	± 0.061	± 0.037	± 0.077	± 0.144	± 0.189	± 0.248
Phase (°)	± 0.402	± 0.246	± 0.508	± 0.950	± 1.800	± 1.636
S_{12} Transmission Tracking ¹						
Mag	± 0.051	± 0.041	± 0.071	± 0.135	± 0.183	± 0.242
Phase (°)	± 0.338	± 0.268	± 0.468	± 0.891	± 1.208	± 1.598

¹Temperature deviation is a characteristic value.

Specifications: N5244A and N5245A Option H29 (continued)

Transmission Uncertainty (S21)

The following charts were generated for Opt 423 / H29.

N5244A Opt 423 / H29 with 85056A (S21)

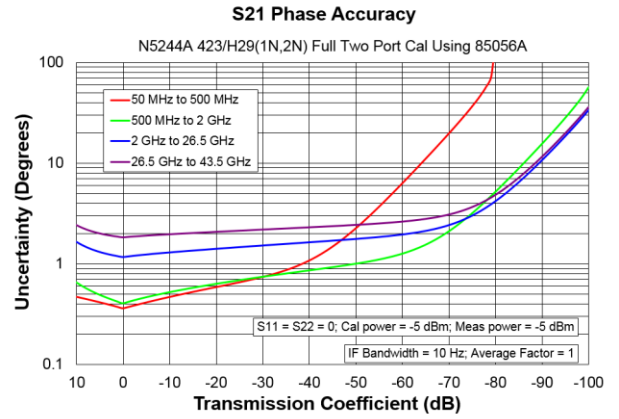
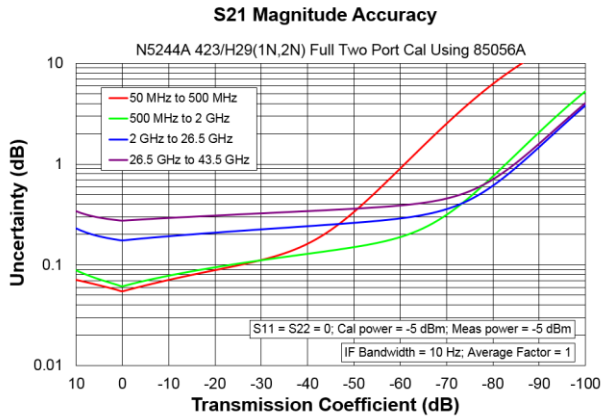

N5245 Opt 423 / H29 with 85056A (S21)

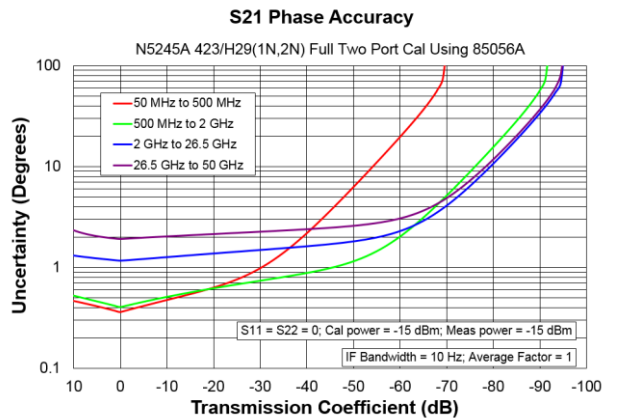
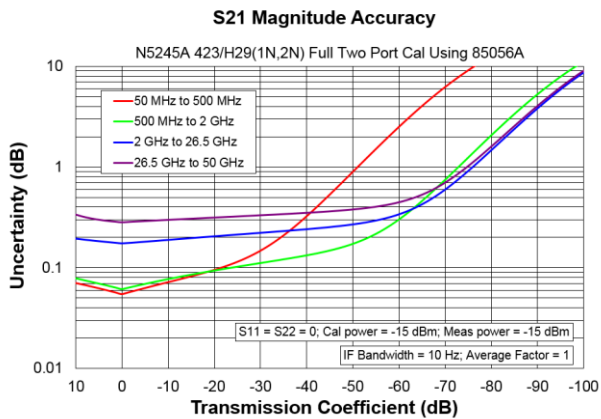

Specifications: N5244A and N5245A Option H29 (continued)

Transmission Uncertainty (S12)

The following charts were generated for Opt 423 / H29.

N5244A Opt 423 / H29 with 85056A (S12)

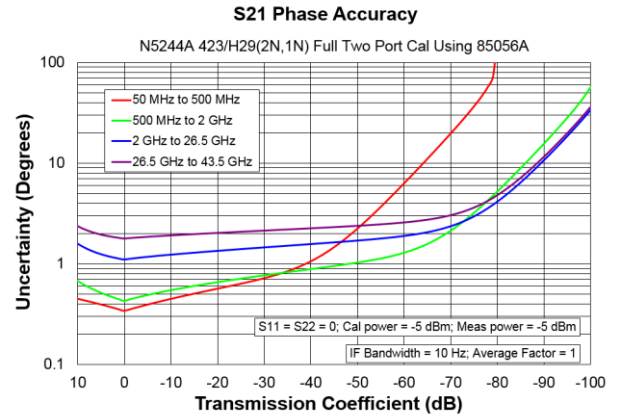
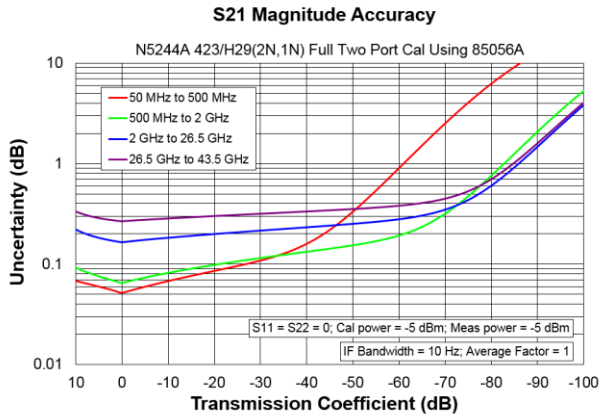

N5245 Opt 423 / H29 with 85056A (S12)

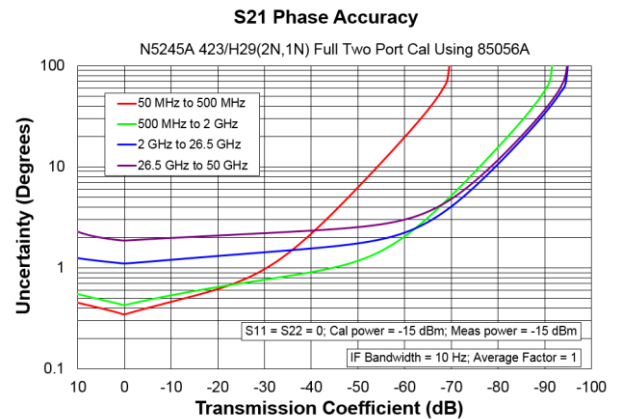
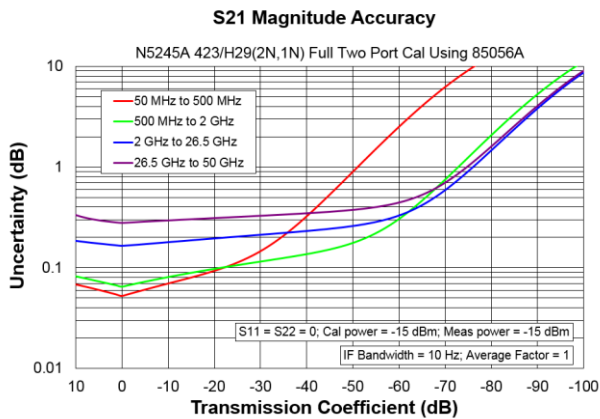

Specifications: N5244A and N5245A Option H29 (continued)

Reflection Uncertainty

The following charts were generated for Opt 423 / H29.

N5244A Opt 423 / H29 with 85056A

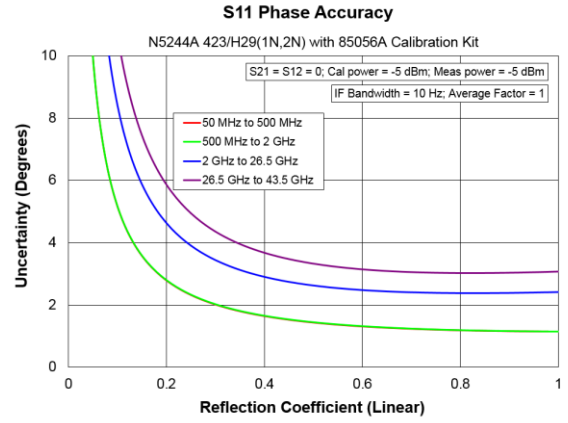
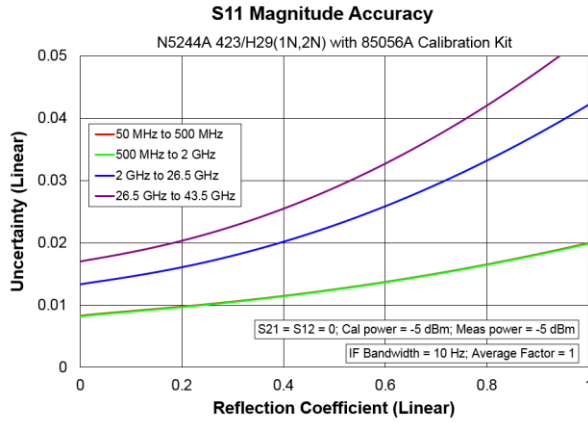

N5245A Opt 423 / H29 with 85056A

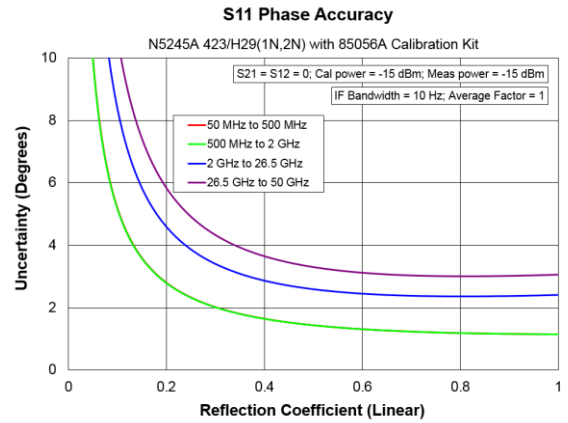
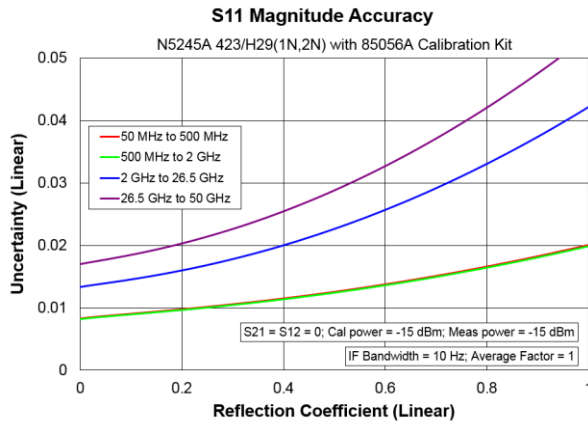

Specifications: N5244A and N5245A Option H29 (continued)

Table 2. N4693A 2-Port Electronic Calibration Module

N5244A and N5245A Option H29

Applies to the N5244A and N5245A analyzer with Option H29, an N4693A (2.4 mm) electronic calibration module, an 85133F flexible test port cable set, and a full 2-port calibration. S-parameter measurements were made with the analyzer in the noise figure configuration. Environmental temperature $23^{\circ} \pm 3^{\circ} \text{C}$, with $< 1^{\circ} \text{C}$ deviation from calibration temperature.

Description	Specification (dB)					
	10 MHz to 45 MHz	45 MHz to 2 GHz	2 GHz to 20 GHz	20 GHz to 26.5 GHz	26.5 GHz to 40 GHz	40 GHz to 50 GHz
Directivity	32	42	45	41	41	36
Source Match	25	44	37	35	35	32
Load Match	25	42	35	33	33	30
Reflection Tracking ¹						
Mag	± 0.050	± 0.030	± 0.050	± 0.060	± 0.060	± 0.080
Phase ($^{\circ}$)	± 0.330	± 0.198	± 0.330	± 0.396	± 0.396	± 0.528
S ₂₁ Transmission Tracking ¹						
Mag	± 0.146	± 0.061	± 0.076	± 0.101	± 0.108	± 0.166
Phase ($^{\circ}$)	± 0.966	± 0.400	± 0.500	± 0.665	± 0.715	± 1.093
S ₁₂ Transmission Tracking ¹						
Mag	± 0.118	± 0.052	± 0.065	± 0.091	± 0.103	± 0.156
Phase ($^{\circ}$)	± 0.781	± 0.341	± 0.431	± 0.598	± 0.681	± 1.032

¹Temperature deviation is a characteristic value.

Specifications: N5244A and N5245A Option H29 (continued)

Transmission Uncertainty (S21)

The following charts were generated for Opt 423 / H29.

N5244A Opt 423 / H29 with N4693A (S21)

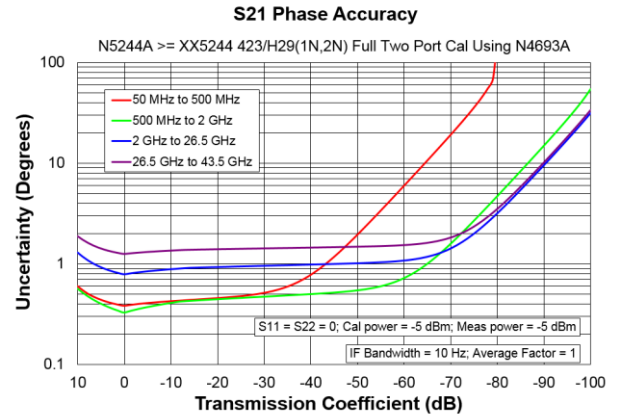
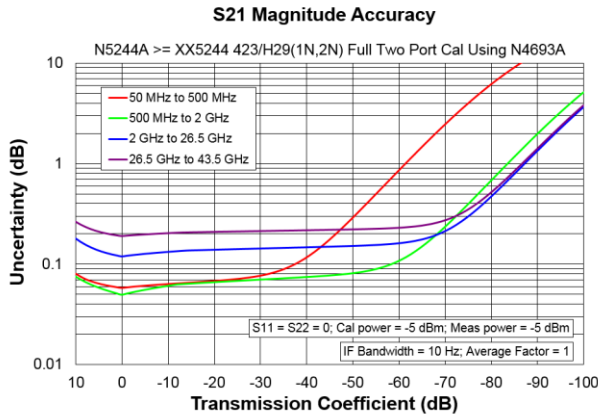

N5245A Opt 423 / H29 with N4693A (S21)

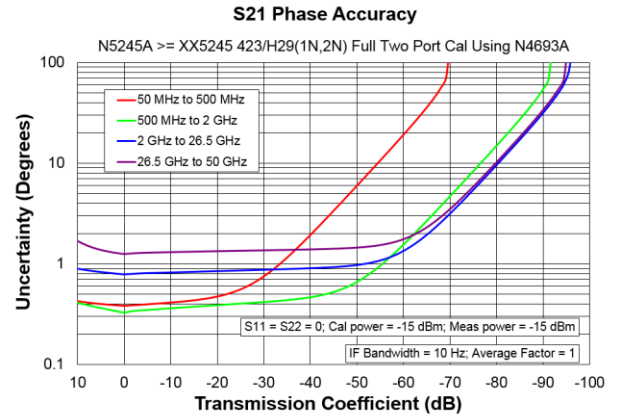
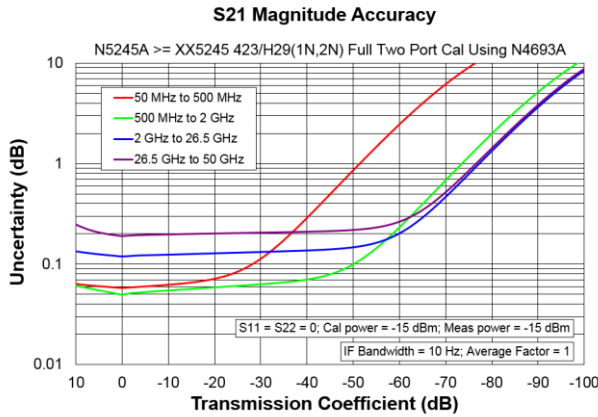

Specifications: N5244A and N5245A Option H29 (continued)

Transmission Uncertainty (S12)

The following charts were generated for Opt 423 / H29.

N5244A Opt 423 / H29 with N4693A (S12)

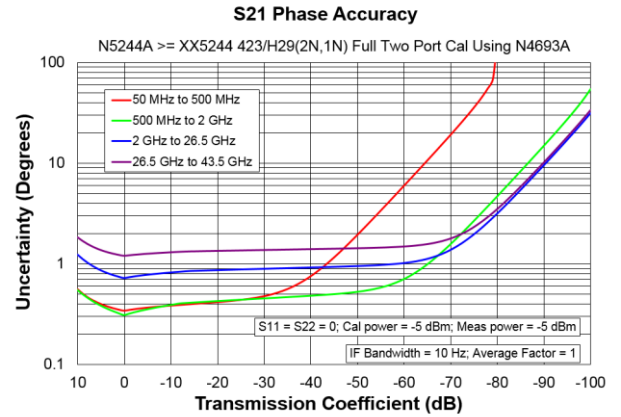
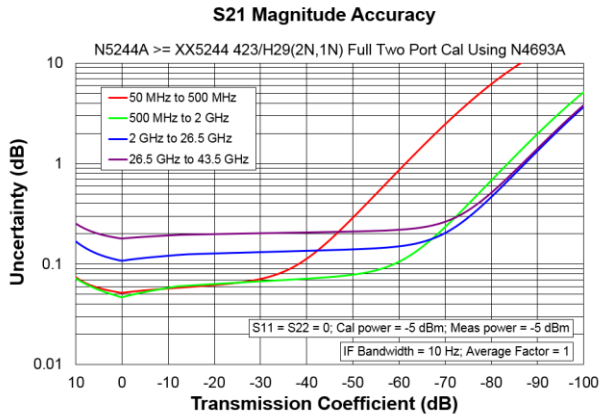

N5245A Opt 423 / H29 with N4693A (S12)

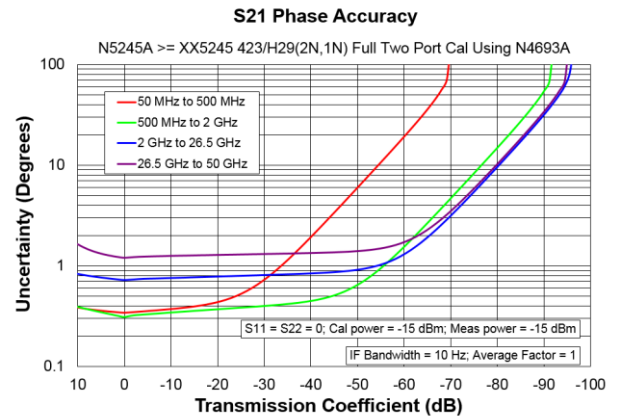
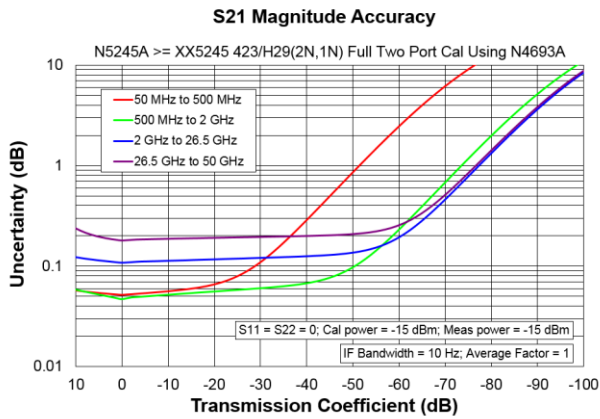

Specifications: N5244A and N5245A Option H29 (continued)

Reflection Uncertainty

The following charts were generated for Opt 423 / H29.

N5244A Opt 423 / H29 with N4693A

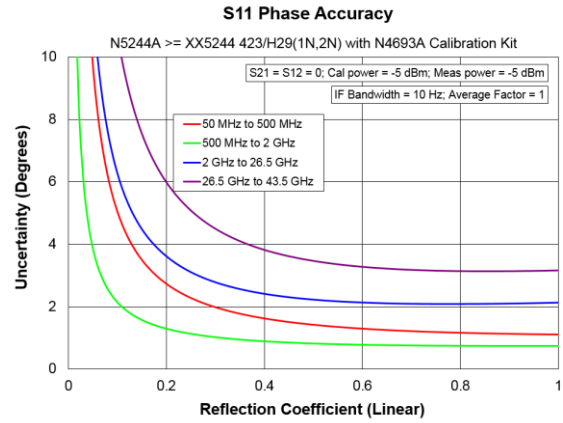
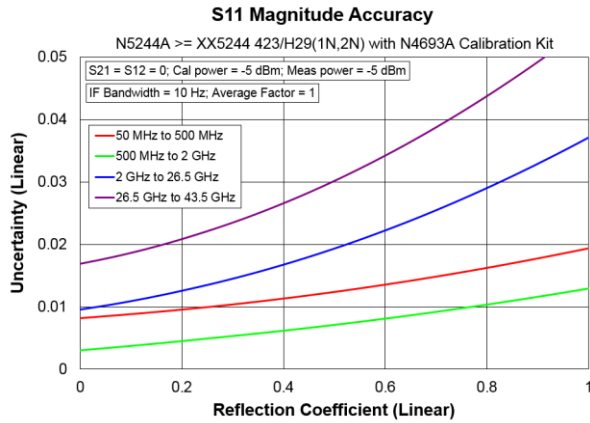

N5245A Opt 423 / H29 with N4693A

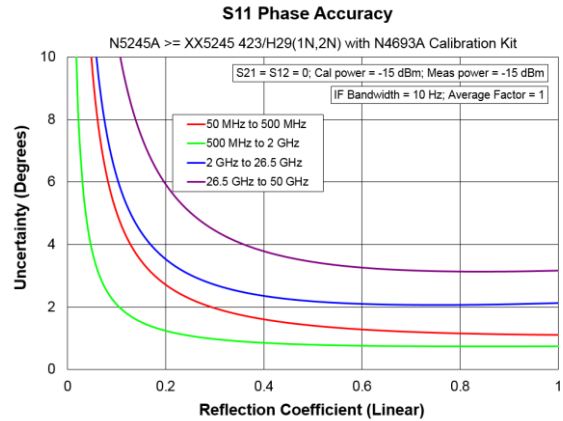
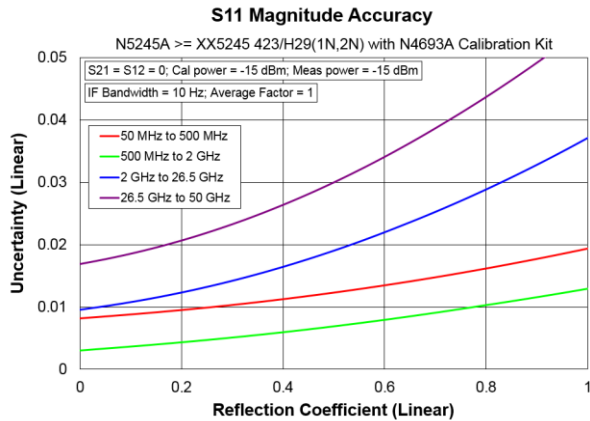

This document does not present specifications for the 85056D Calibration Kit. Please download our free Uncertainty Calculator from http://www.keysight.com/find/na_calculator to generate the data and curves for the 85056D Calibration Kit.

Uncorrected System Performance, N5244A and N5245A Option H29

Noise Error Terms: N5244A and N5245A Option H29

Table 3. Noise State Directivity, Port 1 and Port 2¹ (dB)

Frequency	Specification	Typical
10 MHz to 50 MHz	17	20
50MHz to 200MHz	22	27
200 MHz to 500 MHz	23	27
500 MHz to 3.2 GHz	23	30
3.2 GHz to 10 GHz	22	25
10 GHz to 13.5 GHz	18	23
13.5 GHz to 16 GHz	18	21
16 GHz to 20 GHz	17	19
20 GHz to 24 GHz	15	19
24 GHz to 26.5 GHz	15	21
26.5GHz to 43.5GHz	15	20
43.5GHz to 46GHz	14	20
46GHz to 50GHz	14	18

¹Analyzer test set switches are set in accordance with the Figure 1 block diagram on page 29, but with a jumper replacing the ECal module.

Table 4. Noise State Load Match, Port 1¹ (dB)

Frequency	Specification	Typical
10 MHz to 50 MHz	10	15
50 MHz to 500 MHz	16	22
500 MHz to 3.2 GHz	12	16
3.2 GHz to 10 GHz	10	18
10 GHz to 13.5 GHz	10	17
13.5 GHz to 16 GHz	10	15
16 GHz to 20 GHz	10	17
20 GHz to 24 GHz	9	15
24 GHz to 26.5 GHz	8	14
26.5GHz to 43.5GHz	5	10
43.5GHz to 46GHz	5	10
46GHz to 50GHz	5	9

¹Analyzer test set switches are set in accordance with the Figure 1 block diagram on page 29, but with a jumper replacing the ECal module.

Table 5. Noise State Load Match, Port 2¹ (dB)

Frequency	Specification	Typical
10 MHz to 50 MHz	7	12
50 MHz to 500 MHz	12	18
500 MHz to 3.2 GHz	9	11
3.2 GHz to 10 GHz	5.5	9.5
10 GHz to 13.5 GHz	5.5	9.5
13.5 GHz to 16 GHz	5.5	10
16 GHz to 20 GHz	5.5	10
20 GHz to 24 GHz	5.5	11.5
24 GHz to 26.5 GHz	5.5	11.5
26.5GHz to 43.5GHz	4	9
43.5GHz to 46GHz	4	9
46GHz to 50GHz	4	8

¹Analyzer test set switches are set in accordance with the Figure 1 block diagram on page 29, but with a jumper replacing the ECal module.

Table 6. Noise State Reflection Tracking (S_{11} and S_{22}), Min/Max (dB)

Frequency	Specification	Typical(S_{11})	Typical(S_{22})
10 MHz to 50MHz	--	+1.5/-1.5	+1.5/-1.5
50 MHz to 500MHz	--	+1.5/-1.5	+1.5/-1.5
500 MHz to 3.2GHz	--	+1.5/-1.5	+1.5/-1.5
3.2 GHz to 10GHz	--	+1.5/-1.5	+1.5/-1.5
10 GHz to 13.5GHz	--	+1.5/-1.5	+1.5/-1.5
13.5 GHz to 16GHz	--	+1.5/-1.5	+1.5/-1.5
16 GHz to 20GHz	--	+1.5/-1.5	+1.5/-1.5
20 GHz to 24 GHz	--	+1.5/-1.5	+1.5/-1.5
24 GHz to 26.5GHz	--	+1.5/-2.0	+1.5/-1.5
26.5 GHz to 43.5GHz	--	+1.5/-2.5	+1.5/-7
43.5 GHz to 46GHz	--	+1.5/-3.0	+1.5/-9
46 GHz to 50GHz	--	+1.5/-3.5	+1.5/-20

Table 7. Noise State Transmission Tracking, Min/Max (dB)

Frequency	Specification	Typical(Port1)	Typical(Port2)
10 MHz to 50 MHz	--	+1.5/-1.5	+1.5/-1.5
50 MHz to 500 MHz	--	+1.5/-1.5	+1.5/-1.5
500 MHz to 3.2 GHz	--	+1.5/-1.5	+1.5/-1.5
3.2 GHz to 10 GHz	--	+1.5/-1.5	+1.5/-1.5
10 GHz to 13.5 GHz	--	+1.5/-1.5	+1.5/-1.5
13.5 GHz to 16 GHz	--	+1.5/-1.5	+1.5/-1.5
16 GHz to 20 GHz	--	+1.5/-1.5	+1.5/-1.5
20 GHz to 24 GHz	--	+1.5/-1.5	+1.5/-1.5
24 GHz to 26.5 GHz	--	+1.5/-1.5	+1.5/-1.5
26.5 GHz to 43.5GHz	--	+1.5/-5.0	+1.5/-1.5
43.5 GHz to 46GHz	--	+1.5/-5.0	+1.5/-1.5
46 GHz to 50GHz	--	+1.5/-25.0	+1.5/-1.5

Table 8. Noise State Source Match, Port 1¹ (dB)

Frequency	Specification	Typical
10 MHz to 50 MHz	8	12
50 MHz to 500 MHz	16	25
500 MHz to 3.2 GHz	16	21
3.2 GHz to 10 GHz	12	18
10 GHz to 13.5 GHz	12	17
13.5 GHz to 16 GHz	12	17
16 GHz to 20 GHz	12	18
20 GHz to 24 GHz	9	15
24 GHz to 26.5 GHz	9	15
26.5 GHz to 43.5 GHz	5	10
43.5 GHz to 46 GHz	5	11
46 GHz to 50GHz	4	9

¹Analyzer test set switches are set in accordance with the Figure 1 block diagram on page 29, but with a jumper replacing the ECal module.

Table 9. Noise State Source Match, Port 2¹ (dB)

Frequency	Specification	Typical
10 MHz to 50 MHz	8	12
50 MHz to 500 MHz	10	17
500 MHz to 3.2 GHz	10	13
3.2 GHz to 10 GHz	6	8
10 GHz to 13.5 GHz	6	9
13.5 GHz to 16 GHz	6	9
16 GHz to 20 GHz	6	10
20 GHz to 24 GHz	6	10
24 GHz to 26.5 GHz	6	10
26.5 GHz to 43.5 GHz	4	9
43.5 GHz to 46 GHz	4	10
46 GHz to 50GHz	3	8

¹Analyzer test set switches are set in accordance with the Figure 1 block diagram on page 29, but with a jumper replacing the ECal module.

Test Port Input: Option H29

Table 10. Receiver Noise Figure, Port 2 (dB)

Frequency	Specification	Typical
800 kHz High Gain Setting ¹		
10 MHz to 60 MHz ²	22.0	--
60 MHz to 200 MHz	9.0	--
200 MHz to 2 GHz	12.0	--
2 GHz to 13.5 GHz	14.5	--
13.5 GHz to 20 GHz	14.5	--
20 GHz to 26.5 GHz	17.0	--
2 MHz, 4 MHz, 8 MHz BW, High Gain Setting ¹		
10 MHz to 60 MHz ²	22.0	--
60 MHz to 200 MHz	9.0	--
200 MHz to 2 GHz	12.0	--
2 GHz to 13.5 GHz	14.5	--
13.5 GHz to 20 GHz	14.5	--
20 GHz to 26.5 GHz	17.0	--
24 MHz BW, High Gain Setting ¹		
10 MHz to 60 MHz ²	36.5	--
60 MHz to 200 MHz	9.0	--
200 MHz to 2 GHz	12.0	--
2 GHz to 13.5 GHz	14.5	--
13.5 GHz to 16 GHz	14.5	--
16 GHz to 26.5 GHz	18.5	--

¹Using Option H29 noise receivers.

²Noise figure below 60 MHz is degraded due to noise from a local supply regulator in the N5244A/45A.

Table 11. Noise Jitter^{1,2}(dB)

Frequency	Specification	Typical
4 MHz BW, Low Gain Setting		
10 MHz to 15 MHz	0.30	0.15
15 MHz to 3 GHz	0.10	0.07
3 GHz to 13.5 GHz	0.11	0.07
13.5 GHz to 26.5 GHz	0.11	0.07
4 MHz BW, Medium Gain Setting		
10 MHz to 15 MHz	0.30	0.15
15 MHz to 3 GHz	0.10	0.07
3 GHz to 13.5 GHz	0.10	0.07
13.5 GHz to 26.5 GHz	0.10	0.07
4 MHz BW, High Gain Setting		
10 MHz to 15 MHz	0.10	0.07
15 MHz to 3 GHz	0.10	0.07
3 GHz to 13.5 GHz	0.10	0.07
13.5 GHz to 26.5 GHz	0.10	0.07

¹ 201 points, 1 noise average

² May typically be degraded at frequencies below 500 MHz due to spurious noise receiver residuals.

Table 12. Noise Receiver Linearity (dB)

Power Range	Specification	Typical
4 MHz BW, Low Gain Setting		
-36 dBm to -64 dBm	+/-0.05 dB	--
-64 dBm to -70 dBm	+/-0.10 dB	--
4 MHz BW, Medium Gain Setting		
-48 dBm to -76 dBm	+/-0.05 dB	--
-76 dBm to -86 dBm	+/-0.10 dB	--
4 MHz BW, High Gain Setting		
-58 dBm to -84 dBm	+/-0.05 dB	--
-84 dBm to -92 dBm	+/-0.10 dB	--

Table 13. Noise Receiver Input Range

Power Range	Specification		
	High Gain Setting	Medium Gain Setting	Low Gain Setting
500 MHz to 3 GHz			
Max DUT NF + Gain (dB)	32 dB	44 dB	55 dB
Max Input Power (dBm) for <0.1 dB Compression ¹	<=-57 dBm	<=-45 dBm	<=-36 dBm
Max Operating Input Power (dBm)	-37 dBm Typical	-33 dBm Typical	-26 dBm Typical
Limit BW for full NF + Gain	400 MHz	400 MHz	400 MHz
3 GHz to 13.5 GHz			
Max DUT NF + Gain (dB)	46 dB	57 dB	68 dB
Max Input Power (dBm) for <0.1 dB Compression ¹	<=-43 dBm	<=-32 dBm	<=-21 dBm
Max Operating Input Power (dBm) Typical	-23 dBm	-20 dBm	-13 dBm
Limit BW for full NF + Gain	400 MHz	400 MHz	400 MHz
13.5 GHz to 26.5 GHz			
Max DUT NF + Gain (dB)	46 dB	57 dB	68 dB
Max Input Power (dBm) for <0.1 dB Compression ¹	<=-43 dBm	<=-32 dBm	<=-21 dBm
Max Operating Input Power (dBm) Typical	-23 dBm	-20 dBm	-13 dBm
Limit BW for full NF + Gain	400 MHz	400 MHz	400 MHz

¹ Derived from 0.25 dB CW compression specification and -5 dB offset, derived from exponential model for device compression. Referenced to test port 2.

Test Port Output: Option H29

Table 14. Max Leveled Power, Port 1 Filtered Mode (dBm)

Option 423/H29

Frequency	Specification	Typical
10 MHz to 50 MHz	3	10
50 MHz to 500 MHz	7	10
500 MHz to 3.2 GHz	7	9
3.2 GHz to 10 GHz	12	15
10 GHz to 13.5 GHz	10	12
13.5 GHz to 16 GHz	10	12
16 GHz to 20 GHz	9	12
20 GHz to 26.5 GHz	9	12
26.5 GHz to 30 GHz	8	12
30 GHz to 32GHz	6	10
32 GHz to 35 GHz	8	12
35 GHz to 40 GHz	2	6
40 GHz to 43.5 GHz	2	6
43.5 GHz to 47 GHz	-4	2
47 GHz to 50 GHz	-15	-7

Table 15. Max Leveled Power, Port 1 High Power Mode (dBm)

Option 423/H29

Frequency	Specification	Typical
10 MHz to 50 MHz	10	17
50 MHz to 2 GHz	12	15
2 GHz to 3.2 GHz	9	12
3.2 GHz to 10 GHz	12	15
10 GHz to 13.5 GHz	10	12
13.5 GHz to 16 GHz	10	12
16 GHz to 20 GHz	9	12
20 GHz to 26.5 GHz	9	12
26.5 GHz to 30 GHz	8	12
30 GHz to 32 GHz	6	10
32 GHz to 35 GHz	8	12
35 GHz to 40 GHz	2	6
40 GHz to 43.5 GHz	2	6
43.5 GHz to 47 GHz	-4	2
47 GHz to 50 GHz	-15	-7

Table 16. Max Leveled Power, Port 1 Source 1, Combine Mode, Filtered Mode (dBm)

Option 423/H29

Frequency	Specification	Typical
10 MHz to 50 MHz	--	3
50 MHz to 500 MHz	--	3
500 MHz to 3.2 GHz	--	3
3.2 GHz to 10 GHz	--	7
10 GHz to 13.5 GHz	--	3
13.5 GHz to 16 GHz	--	3
16 GHz to 20 GHz	--	1
20 GHz to 24 GHz	--	1
24 GHz to 26.5 GHz	--	1
26.5 GHz to 30 GHz	--	0
32 GHz to 35 GHz	--	0
35 GHz to 40 GHz	--	-6
40 GHz to 43.5 GHz	--	-6
43.5 GHz to 47 GHz	--	-10
47 GHz to 50 GHz	--	-20

Table 17. Max Leveled Power, Port 1 Source 1, Combine Mode, High Power Mode (dBm)

Option 423/H29

Frequency	Specification	Typical
10 MHz to 50 MHz	--	10
50 MHz to 500 MHz	--	10
500 MHz to 3.2 GHz	--	4
3.2 GHz to 10 GHz	--	7
10 GHz to 13.5 GHz	--	3
13.5 GHz to 16 GHz	--	3
16 GHz to 20 GHz	--	1
20 GHz to 24 GHz	--	1
24 GHz to 26.5 GHz	--	1
26.5 GHz to 30 GHz	--	0
32 GHz to 35 GHz	--	0
35 GHz to 40 GHz	--	-6
40 GHz to 43.5 GHz	--	-6
43.5 GHz to 47 GHz	--	-10
47 GHz to 50 GHz	--	-20

Table 18. Max Leveled Power, Port 1 Source 2, Combine Mode, Filtered Mode (dBm)

Option 423/H29

Frequency	Specification	Typical
10 MHz to 50 MHz	--	4
50 MHz to 500 MHz	--	3
500 MHz to 3.2 GHz	--	3
3.2 GHz to 10 GHz	--	6
10 GHz to 13.5 GHz	--	3
13.5 GHz to 16 GHz	--	3
16 GHz to 20 GHz	--	1
20 GHz to 24 GHz	--	1
24 GHz to 26.5 GHz	--	1
26.5 GHz to 30 GHz	--	-1
32 GHz to 35 GHz	--	-1
35 GHz to 40 GHz	--	-7
40 GHz to 43.5 GHz	--	-7
43.5 GHz to 47 GHz	--	-12
47 GHz to 50 GHz	--	-24

Table 19. Max Leveled Power, Port 1 Source 2, Combine Mode, High Power Mode (dBm)

Option 423/H29

Frequency	Specification	Typical
10 MHz to 50 MHz	--	10
50 MHz to 500 MHz	--	10
500 MHz to 3.2 GHz	--	4
3.2 GHz to 10 GHz	--	6
10 GHz to 13.5 GHz	--	3
13.5 GHz to 16 GHz	--	3
16 GHz to 20 GHz	--	1
20 GHz to 24 GHz	--	1
24 GHz to 26.5 GHz	--	1
26.5 GHz to 30 GHz	--	-1
32 GHz to 35 GHz	--	-1
35 GHz to 40 GHz	--	-7
40 GHz to 43.5 GHz	--	-7
43.5 GHz to 47 GHz	--	-12
47 GHz to 50 GHz	--	-24

Table 20. Max Leveled Power, Port 2 (dBm)

Option 423/H29

Frequency	Specification	Typical
10 MHz to 50 MHz	9	18
50 MHz to 500 MHz	12	18
500 MHz to 3.2 GHz	12	15
3.2 GHz to 10 GHz	12	15
10 GHz to 13.5 GHz	10	12
13.5 GHz to 16 GHz	10	12
16 GHz to 20 GHz	8	11
20 GHz to 26.5 GHz	8	11
26.5 GHz to 30 GHz	7	11
30 GHz to 32 GHz	5	9
32 GHz to 35 GHz	7	11
35 GHz to 40 GHz	1	5
40 GHz to 43.5 GHz	1	5
43.5 GHz to 47 GHz	-5	2
47 GHz to 50 GHz	-15	-6

Test Set Block Diagrams

NOTE: For best readability, use a color printer for printing the following graphics.

Figure 1. 4-Port N5244A and N5245A Option 423/H29

Adds internal combiner and mechanical switches.

Also shown, Option 025 adds 4 pulse generators. Option 021 and 022 adds pulse modulators.

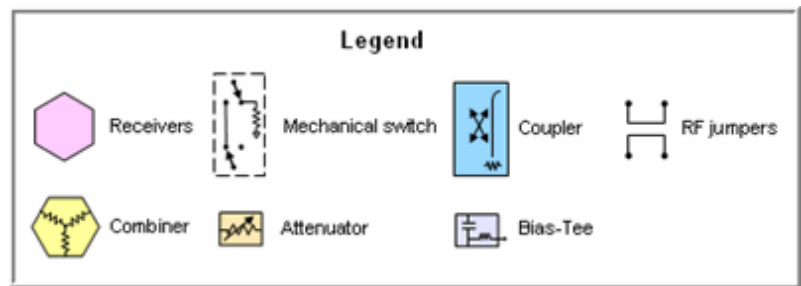
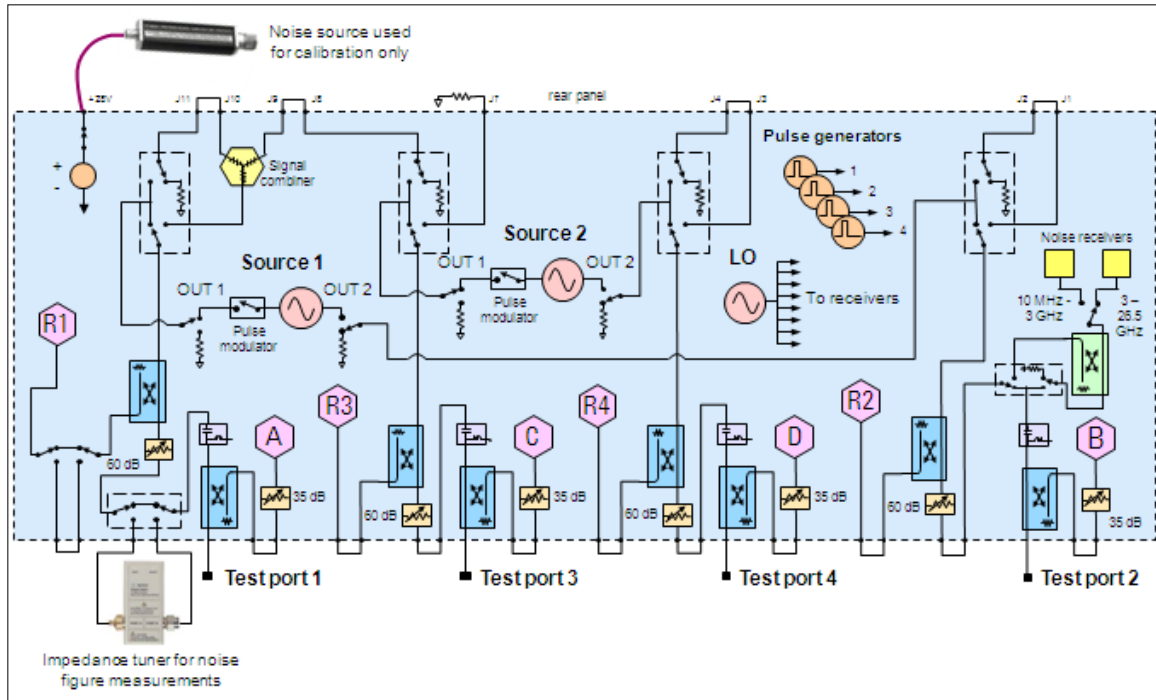

Receiver Block Diagram

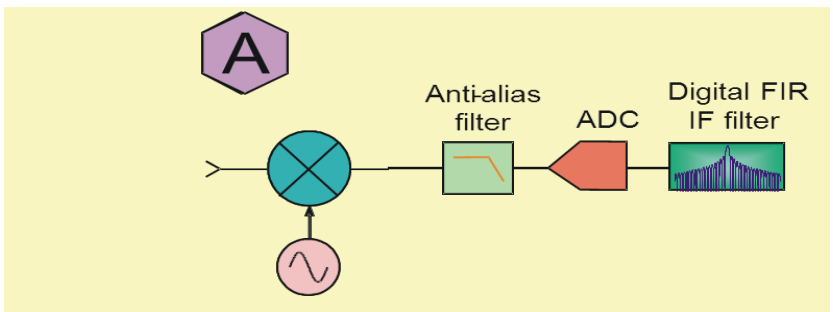



This information is subject to change without notice.
© Keysight Technologies 2014-2017
Print Date: February 22, 2017



N5245-90016

www.keysight.com