Keysight 2-Port and 4-Port Broadband Network Analyzer

N5290A 500 Hz to 125 GHz

(for synthesizer revision 6 or earlier)

Documentation Warranty

THE MATERIAL CONTAINED IN THIS DOCUMENT IS PROVIDED "AS IS," AND IS SUBJECT TO BEING CHANGED, WITHOUT NOTICE, IN FUTURE EDITIONS. FURTHER, TO THE MAXIMUM EXTENT PERMITTED BY APPLICABLE LAW, KEYSIGHT DISCLAIMS ALL WARRANTIES, EITHER EXPRESS OR IMPLIED WITH REGARD TO THIS MANUAL AND ANY INFORMATION CONTAINED HEREIN, INCLUDING BUT NOT LIMITED TO THE IMPLIED WARRANTIES OF MERCHANTABILITY AND FITNESS FOR A PARTICULAR PURPOSE. KEYSIGHT SHALL NOT BE LIABLE FOR ERRORS OR FOR INCIDENTAL OR CONSEQUENTIAL DAMAGES IN CONNECTION WITH THE FURNISHING, USE, OR PERFORMANCE OF THIS DOCUMENT OR ANY INFORMATION CONTAINED HEREIN. SHOULD KEYSIGHT AND THE USER HAVE A SEPARATE WRITTEN AGREEMENT WITH WARRANTY TERMS COVERING THE MATERIAL IN THIS DOCUMENT THAT CONFLICT WITH THESE TERMS, THE WARRANTY TERMS IN THE SEPARATE AGREEMENT WILL CONTROL.

U.S. Government Rights

U.S. Government Rights. The Software is "commercial computer software," as defined by Federal Acquisition Regulation ("FAR") 2.101. Pursuant to FAR 12.212 and 27.405-3 and Department of Defense FAR Supplement ("DFARS") 227.7202, the U.S. government acquires commercial computer software under the same terms by which the software is customarily provided to the public. Accordingly, Keysight provides the Software to U.S. government customers under its standard commercial license, which is embodied in its End User License Agreement (EULA), a copy of which can be found at <http://www.keysight.com/find/sweula>. The license set forth in the EULA represents the exclusive authority by which the U.S. government may use, modify, distribute, or disclose the Software. The EULA and the license set forth therein, does not require or permit, among other things, that Keysight: (1) Furnish technical information related to commercial computer software or commercial computer software documentation that is not customarily provided to the public; or (2) Relinquish to, or otherwise provide, the government rights in excess of these rights customarily provided to the public to use, modify, reproduce, release, perform, display, or disclose commercial computer software or commercial computer software documentation. No additional government requirements beyond those set forth in the EULA shall apply, except to the extent that those terms, rights, or licenses are explicitly required from all providers of commercial computer software pursuant to the FAR and the DFARS and are set forth specifically in writing elsewhere in the EULA. Keysight shall be under no obligation to update, revise or otherwise modify the Software. With respect to any technical data as defined by FAR 2.101, pursuant to FAR 12.211 and 27.404.2 and DFARS 227.7102, the U.S. government acquires no greater than Limited Rights as defined in FAR 27.401 or DFAR 227.7103-5 (c), as applicable in any technical data.

System Dynamic Range and Receiver Dynamic Range	10
System Dynamic Range	11
Table 1. N5291A System Dynamic Range (dB).....	11
Table 2. N5291A System Dynamic Range (dB), All Ports (LFE Enabled).....	12
Receiver Dynamic Range - Typical	12
Table 3. N5291A Receiver Dynamic Range (dB)	12
Table 4. N5291A Receiver Dynamic Range (dB), All Ports (LFE Enabled)	13
Test Port Output – 500 Hz to 125 GHz	14
Maximum Power	14
Table 5. Test Port Maximum Power (dBm), All Models, All Options	14
Table 6. Maximum Power (dBm), All Ports (LFE Enabled)	14
Port Power Level Accuracy	15
Table 7. Port Power Level Accuracy ¹ (dB), All Ports, All Options	15
Table 8. Port Power Level Accuracy ¹ (dB), All Ports, All Options (LFE Enabled)	16
Port Power Linearity	16
Table 9. Port Power Linearity ¹ (dB), All Ports, Option 201, 202, 401, 402, 403	16
Table 10. Power Level Linearity ¹ (dB), All Ports (LFE Enabled)	16
Port Harmonics	17
Table 11. Harmonics, All Options – Typical.....	17
Table 12. 2 nd and 3 rd Harmonics at Max Specified Power (dBc), All Ports – Typical (LFE Enabled)	18
Source Phase Noise	18
Table 13. Phase Noise (dBc/Hz), All Options – Typical	18
Table 14. Phase Noise (dBc/Hz), All Ports – Typical (LFE Enabled)	18
Test Port Input – 500 Hz to 125 GHz	19
Noise Floor	19
Table 15. Test Port Noise Floor (dBm) @ 10 Hz IFBW, All Options	19
Table 16. Test Port Noise Floor (dBm) @ 10 Hz IFBW, All Options (LFE Enabled).....	20
Trace Noise	20
Table 17. Trace Noise, Magnitude (dB rms), All Options	20
Table 18. Trace Noise, Magnitude ¹ (dB rms), All Ports, All Options (LFE Enabled)	20
Table 19. Trace Noise, Phase (deg rms), All Ports, All Options.....	21
Table 20. Trace Noise, Phase ¹ (deg rms), All Ports, All Options (LFE Enabled).....	21

Compression	22
Table 21. Compression ¹ , All Ports - Typical.....	22
Table 22. Compression, All Ports (LFE Enabled) - Typical	23
Table 23. 0.1 dB Compression, All Ports, All Options - Typical	23
Table 24. 0.1 dB Compression, All Ports, All Options (LFE Enabled) - Typical	24
Damage Input Level	24
Table 25. Damage Input Level, All Options	24
Bias Tee Leakage Current	24
Table 26. Leakage Current (Average Typical)	24
Dynamic Accuracy	25
Table 27. N5291A Dynamic Accuracy, 900 Hz (LFE Enabled) - Specification	25
Table 28. N5291A Dynamic Accuracy, 10 MHz (LFE Enabled) - Specification.....	25
Table 29. N5291A Dynamic Accuracy, 100 MHz (LFE Enabled) - Specification.....	26
Table 30. N5291A Dynamic Accuracy, 1 GHz - Specification	26
Table 31. N5291A Dynamic Accuracy, 26.5 GHz - Specification	26
Table 32. N5291A Dynamic Accuracy, 50 GHz - Specification	27
Table 33. N5291A Dynamic Accuracy, 67 GHz - Specification	27
Table 34. N5291A Dynamic Accuracy, 110 GHz - Specification	28
Table 35. N5291A Dynamic Accuracy, 120 GHz – Specification	28
Group Delay - Typical	29
Table 36. Group Delay - Typical	29
N5291A Stability	30
Transmission Magnitude Stability (Nominal).....	30
Transmission Phase Stability (Nominal).....	30
Reflection Magnitude Stability (Nominal)	31
Reflection Phase Stability (Nominal)	31
Table 37. N5291A Stability – Typical (10 MHz to 125 GHz) (LFE Disabled).....	32
Table 38. Receiver Stability (LFE Enabled) - Typical.....	32
Uncorrected System Performance	33
Table 39. Error Terms (dB), All Ports, All Options – Specification	33
Table 40. Error Terms (dB), All Ports, All Options – Specification (LFE Enabled).....	33
Table 41. Error Terms (dB), All Ports, All Options – Typical.....	34
Table 42. Error Terms (dB), All Ports, All Options – Typical (LFE Enabled)	34

Corrected System Performance	35
N5291A System (10 MHz to 120 GHz) (LFE Disabled)	35
Table 43. Error Terms (dB), All Ports, All Options – Specifications.....	35
Transmission Uncertainty, (LFE Disabled).....	36
Reflection Uncertainty, (LFE Disabled)	36
N5291A System (900 Hz to 100 MHz) (LFE Enabled)	37
Table 44. Error Terms (dB), All Ports, All Options – Specification (LFE Enabled).....	37
Transmission Uncertainty, (LFE Enabled)	37
Reflection Uncertainty, (LFE Enabled)	37
General Information	38
Table 45. Miscellaneous Information	38
Table 46. N5295AXxx Frequency Extenders	38
Table 47. N5292A Test Set Front Panel	38
Table 48. N5292A Test Set Rear Panel.....	39
Table 49. VNA Front Panel Information, All Options	39
Table 50. VNA Rear Panel Information, All Options	40
Table 51. (Continued) VNA Rear Panel Information, All Options	41
Table 52. (Continued) VNA Rear Panel Information, All Options	42
System Dimensions and Weight	42
Regulatory and Environmental Information	42
Measurement Throughput Summary	43
Table 53. Typical Cycle Time (ms) for Measurement Completion, All Models and Options.....	43
Table 54. Cycle Time vs. IF Bandwidth - Typical	44
Table 55. Cycle Time vs. Number of Points - Typical	44
Table 56. Data Transfer Time (ms) - Typical	45
N5291A System Block Diagram	46
N5291A Option 201, 205 System Level Block Diagram	46
N5291A Option 202, 205 System Level Block Diagram	47
N5291A Option 401 System Level Block Diagram	48
N5291A Option 402 System Level Block Diagram	49
N5291A Option 403 System Level Block Diagram	50

N5291A System Options

This is a complete list of the technical specifications for the N5291A Broadband millimeter wave Network Analyzer

Option 201

- N5222B 2-port PNA with option 205 and 020
- N5292A Millimeter wave test set controller with options 200 and 222
- 2 N5295AX03 Frequency extenders

Option 202

- N5227B 2-port PNA with option 205 and 020
- N5292A Millimeter wave test set controller with options 200 and 222
- 2 N5295AX03 Frequency extenders

Option 401

- N5242B 4-port PNA-X with option 425 and 020
- N5292A Millimeter wave test set controller with options 400 and 442
- 4 N5295AX03 Frequency extenders

Option 402

- N5242B 4-port PNA-X with options 425, 029, and 020
- N5292A Millimeter wave test set with options 400 and 442
- 4 N5295AX03 Frequency extenders

Option 403

- N5247B 4-port PNA-X with options 425, 029, and 020
- N5292A Millimeter wave test set with options 400 and 444
- 4 N5295AX03 Frequency extenders

Instrument Options

Option 020 – Adds IF inputs on the rear panel.

Option 029 – Adds hardware and firmware of high-accuracy noise figure measurements.

Option 205 – Adds front-panel jumpers, R1 receiver switch, and Low Frequency Extension (LFE) hardware.

Option 425 – Adds source and receiver attenuators, internal second source, combiner, mechanical switches, low frequency extension (LFE) hardware, and dedicated 26.5 GHz noise receiver.

For Spectrum Analyzer option information, please refer to document **N5224-90010** 'Keysight Spectrum Analyzer Option (090/S93090xA) for PNA/PNA-L/PNA-X/N5290A/N5291A'.

This document is written for the N5291A with five options (configurations) as given in the previous page. Broadband network analyzers can also be configured with other PNA/-X models with other options and one of the frequency extenders as given in the section, “Configuring Broadband Using Separate System Components” in the N5290A/91A configuration guide, 5992-2179EN. The typical data in this document is valid for the N5291A and these configurations. The system level specifications in this document are however only valid for the five options of the N5291A system.

A full system calibration and compliance to document specifications can only be obtained with the five options of the N5291A system. All other configurations will receive individual component functional certifications (typical specifications).

PNA/PNA-X	Frequency coverage	Bias tee configuration	Cable length
N5295AX01	10 MHz to 120 GHz	No bias	1.2 m cable
N5295AX02	10 MHz to 120 GHz	Pulsed bias	1.2 m cable
N5295AX03	900 Hz to 120 GHz	Low frequency bias combiner with built-in bias tee	1.2 m cable
N5295AX51	10 MHz to 120 GHz	No bias	1.8 m cable
N5295AX52	10 MHz to 120 GHz	Pulsed bias	1.8 m cable
N5295AX53	900 Hz to 120 GHz	Low frequency bias combiner with built-in bias tee	1.8 m cable

Definitions

All specifications and characteristics apply over a 25 °C ±5 °C range (unless otherwise stated) and 90 minutes after the instrument has been turned on.

Specification (spec.): Warranted performance. Specifications include guardbands to account for the expected statistical performance distribution, measurement uncertainties, and changes in performance due to environmental conditions.

Characteristic (char.): A performance parameter that the product is expected to meet before it leaves the factory, but that is not verified in the field and is not covered by the product warranty. A characteristic includes the same guardbands as a specification.

Typical (typ.): Expected performance of an average unit which does not include guardbands. It is not covered by the product warranty.

Nominal (nom.): A general, descriptive term that does not imply a level of performance. It is not covered by the product warranty.

Calibration: The process of measuring known standards to characterize a network analyzer's systematic (repeatable) errors.

Corrected (residual): Indicates performance after error correction (calibration). It is determined by the quality of calibration standards and how well "known" they are, plus system repeatability, stability, and noise.

Uncorrected (raw): Indicates instrument performance without error correction. The uncorrected performance affects the stability of a calibration.

Standard: When referring to the analyzer, this includes no options unless noted otherwise.

Standard and LFE measurements: With PNA/PNA-X option 205 or 425, which adds Low Frequency Extension (LFE) hardware, the LFE measurement range overlaps with the standard measurement range from 10 MHz to 100 MHz. With LFE Enabled, measurements from 500 Hz to 100 MHz use LFE hardware. With LFE Disabled, measurements from 10 MHz to 100 MHz use standard hardware. To measure below 10 MHz, LFE must be enabled. All measurements above 100 MHz use standard hardware, regardless of the LFE Enabled/Disabled setting.

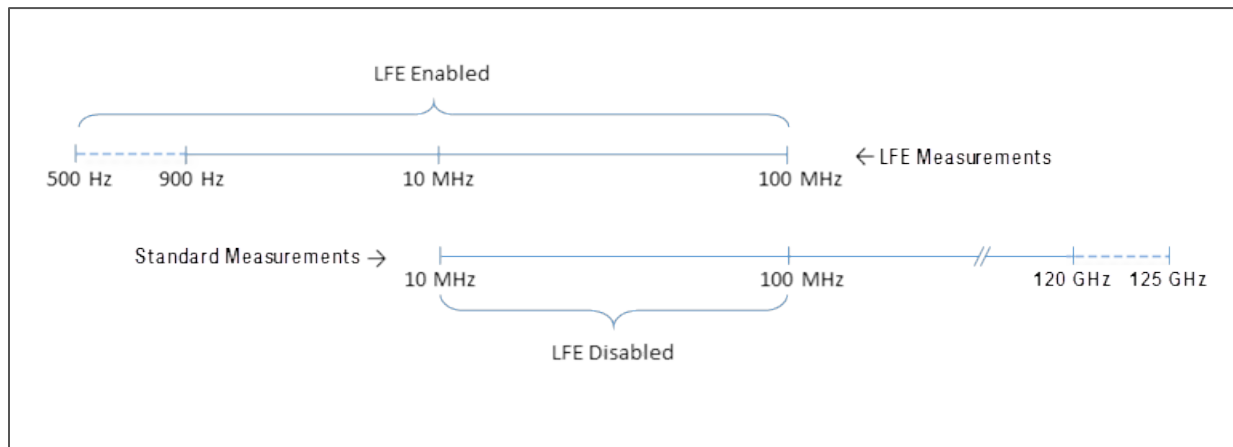

Traceability: Power measurements are traceable to 110 GHz. Power measurements above 110 GHz are compared against a VDI calorimeter (VDI Model PM5) with partial measurement uncertainty. S-parameters are traceable to 120 GHz.

Notes

Please download our free Uncertainty Calculator from http://www.Keysight.com/find/na_calculator to generate the curves for your calibration kit and PNA setup.

Typical performance information between 500 Hz and 125 GHz is shown in this document where available.

All data presented is at the test port of the frequency extenders only.

NOTE

LFE refers to the Option 205/425 Low Frequency Extension.

System Dynamic Range and Receiver Dynamic Range

- **System Dynamic Range** is based on the measured source maximum output power (A) minus the measured noise floor (B).
- **Receiver Dynamic Range** is defined as the typical 0.1 dB compression (C) minus the typical noise floor (D).

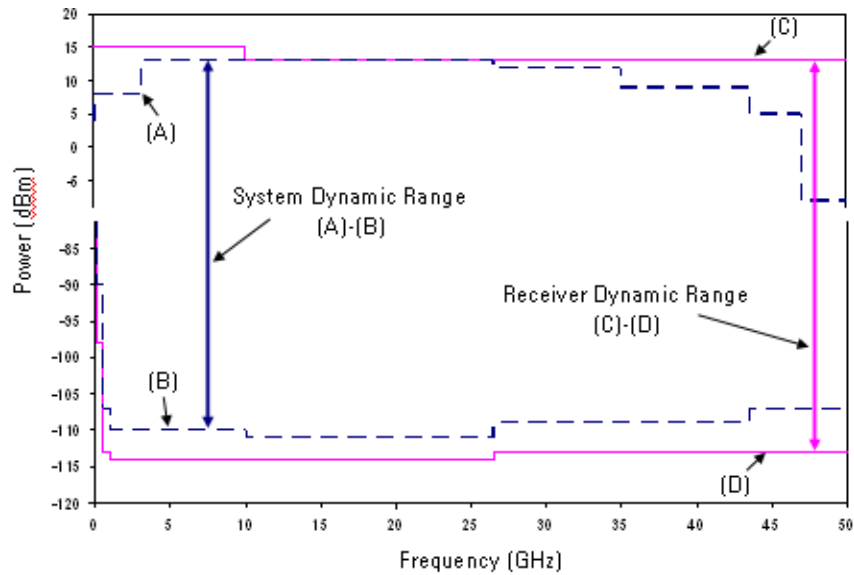

System Dynamic Range

Table 1. N5291A System Dynamic Range (dB)

Description	Specification		Typical	
	Ports 1 & 3	Ports 2 & 4	Ports 1 & 3	Ports 2 & 4
10 MHz to 50 MHz ¹	67	67	91	91
50 MHz to 100 MHz ¹	90	90	107	107
100 MHz to 500 MHz	99	99	119	119
500 MHz to 1 GHz	113	113	127	127
1 GHz to 2 GHz	121	121	132	132
2 GHz to 2.5 GHz	119	121	132	131
2.5 GHz to 3.2 GHz	119	121	130	131
3.2 GHz to 5 GHz	126	126	133	133
5 GHz to 8 GHz	126	126	132	131
8 GHz to 10 GHz	125	123	131	130
10 GHz to 12 GHz	124	123	130	129
12 GHz to 13.5 GHz	123	121	130	129
13.5 GHz to 15 GHz	123	121	130	130
15 GHz to 16 GHz	122	121	130	130
16 GHz to 18 GHz	122	121	130	129
18 GHz to 20 GHz	121	117	129	127
20 GHz to 24 GHz	119	115	128	126
24 GHz to 26.5 GHz	121	121	129	129
26.5 GHz to 30 GHz	114	114	121	121
30 GHz to 35 GHz	114	114	122	122
35 GHz to 40 GHz	112	112	120	120
40 GHz to 45 GHz	114	114	122	122
45 GHz to 50 GHz	114	114	122	122
50 GHz to 52 GHz	114	113	122	121
52 GHz to 60 GHz	115	115	123	123
60 GHz to 64 GHz	114	114	122	122
64 GHz to 67 GHz	111	111	119	119
67 GHz to 70 GHz	111	111	119	119
70 GHz to 75 GHz	108	108	118	118
75 GHz to 80 GHz	108	108	114	114
80 GHz to 85 GHz	108	108	115	115
85 GHz to 90 GHz	108	108	115	115
90 GHz to 95 GHz	108	108	116	116
95 GHz to 100 GHz	106	106	116	116
100 GHz to 105 GHz	104	104	113	113
105 GHz to 110 GHz	105	105	114	114
110 GHz to 115 GHz	98	98	114	114
115 GHz to 120 GHz	93	93	107	107
120 GHz to 125 GHz	--	--	103	103

¹ With PNA/PNA-X Option 205 or 425 installed and LFE disabled, applied to frequencies ≤100 MHz. Above 100 MHz, performance is the same for both LFE enabled or disabled. For LFE enabled performance ≤100 MHz, see Table 2.

Table 2. N5291A System Dynamic Range (dB), All Ports (LFE Enabled)

Description	Specification		Typical	
	Ports 1, 3	Ports 2, 4	Ports 1, 3	Ports 2, 4
500 Hz to 900 Hz	--	--	97	97
900 Hz to 1 kHz	93	93	103	104
1 kHz to 10 kHz	96	96	104	105
10 kHz to 100 kHz	111	112	117	117
100 kHz to 1 MHz	115	117	121	122
1 MHz to 5 MHz	115	116	121	121
5 MHz to 10 MHz	105	106	112	112
10 MHz to 50 MHz	99	100	107	107
50 MHz to 100 MHz	99	100	106	107

Receiver Dynamic Range - Typical

Table 3. N5291A Receiver Dynamic Range (dB)

Description	Typical
10 MHz to 50 MHz ¹	92
50 MHz to 100 MHz ¹	105
100 MHz to 500 MHz	117
500 MHz to 1 GHz	125
1 GHz to 2 GHz	128
2 GHz to 5 GHz	127
5 GHz to 20 GHz	128
20 GHz to 24 GHz	127
24 GHz to 26.5 GHz	128
26.5 GHz to 32 GHz	119
32 GHz to 40 GHz	119
40 GHz to 50 GHz	119
50 GHz to 60 GHz	121
60 GHz to 64 GHz	122
64 GHz to 67 GHz	120
67 GHz to 70 GHz	120
70 GHz to 75 GHz	119
75 GHz to 80 GHz	114
80 GHz to 90 GHz	114
90 GHz to 95 GHz	113
95 GHz to 100 GHz	112
100 GHz to 105 GHz	108
105 GHz to 110 GHz	109
110 GHz to 115 GHz	108
115 GHz to 120 GHz	103
120 GHz to 125 GHz	101

¹ With PNA/PNA-X Option 205 or 425 installed and LFE disabled, applied to frequencies ≤100 MHz. Above 100 MHz, performance is the same for both LFE enabled or disabled. For LFE enabled performance ≤100 MHz, see Table 4.

Table 4. N5291A Receiver Dynamic Range (dB), All Ports (LFE Enabled)

Description	Typical
500 Hz to 900 Hz	101
900 Hz to 1 kHz	105
1 kHz to 10 kHz	106
10 kHz to 100 kHz	117
100 kHz to 1 MHz	121
1 MHz to 5 MHz	121
5 MHz to 10 MHz	114
10 MHz to 50 MHz	115
50 MHz to 100 MHz	115

Test Port Output – 500 Hz to 125 GHz

Maximum Power

Table 5. Test Port Maximum Power¹ (dBm), All Models, All Options

Description	Specification		Typical	
	Ports 1 & 3	Ports 2 & 4	Ports 1 & 3	Ports 2 & 4
10 MHz to 50 MHz ²	0	0	9	9
50 MHz to 100 MHz ²	7	7	12	12
100 MHz to 500 MHz	7	7	12	12
500 MHz to 1 GHz	8	8	12	12
1 GHz to 2 GHz	10	10	13	13
2 GHz to 2.5 GHz	5	7	13	12
2.5 GHz to 3.2 GHz	5	7	11	12
3.2 GHz to 5 GHz	10	10	14	14
5 GHz to 8 GHz	10	10	13	13
8 GHz to 10 GHz	9	7	12	11
10 GHz to 12 GHz	8	7	11	10
12 GHz to 13.5 GHz	7	5	10	9
13.5 GHz to 15 GHz	7	5	10	10
15 GHz to 16 GHz	6	5	10	10
16 GHz to 18 GHz	6	5	10	9
18 GHz to 20 GHz	5	1	9	7
20 GHz to 24 GHz	4	0	8	6
24 GHz to 26.5 GHz	6	6	9	9
26.5 GHz to 30 GHz	6	6	9	9
30 GHz to 35 GHz	6	6	10	10
35 GHz to 40 GHz	4	4	8	8
40 GHz to 45 GHz	6	6	10	10
45 GHz to 50 GHz	5	5	10	10
50 GHz to 52 GHz	5	4	9	8
52 GHz to 60 GHz	6	6	10	10
60 GHz to 64 GHz	4	4	9	9
64 GHz to 67 GHz	1	1	5	5
67 GHz to 70 GHz	1	1	5	5
70 GHz to 75 GHz	1	1	5	5
75 GHz to 80 GHz	1	1	5	5
80 GHz to 85 GHz	1	1	5	5
85 GHz to 90 GHz	1	1	5	5
90 GHz to 95 GHz	1	1	5	5
95 GHz to 100 GHz	1	1	6	6
100 GHz to 105 GHz	1	1	6	6
105 GHz to 110 GHz	1	1	6	6
110 GHz to 115 GHz	1	1	6	6
115 GHz to 120 GHz	-2	-2	4	4
120 GHz to 125 GHz	--	--	2	2

¹ When the N524xB PNA-X is used, the numbers are valid only when the high power mode is selected for the signal source.

² With PNA/PNA-X Option 205 or 425 installed and LFE disabled, applied to frequencies ≤100 MHz. Above 100 MHz, performance is the same for both LFE enabled or disabled. For LFE enabled performance ≤100 MHz, see Table 6.

Table 6. Maximum Power (dBm), All Ports (LFE Enabled)

Description	Specification	Typical ¹
500 Hz to 900 Hz	--	8
900 Hz to 1 kHz	4	11
1 kHz to 10 kHz	8	11

10 kHz to 100kHz	8	12
100 kHz to 1 MHz	10	12
1 MHz to 5 MHz	7	10
5 MHz to 10 MHz	3	8
10 MHz to 50 MHz	3	5
50 MHz to 100 MHz	3	5

¹Values apply to all ports. Ports 2 and 4 typically 1 dB higher.

Port Power Level Accuracy

Table 7. Port Power Level Accuracy¹ (dB), All Ports, All Options

Description	Typical
10 MHz to 50 MHz ²	±0.7
50 MHz to 100 MHz ²	±0.6
100 MHz to 500 MHz	±0.7
500 MHz to 1 GHz	±1.6
1 GHz to 2 GHz	±0.6
2 GHz to 5 GHz	±0.5
5 GHz to 20 GHz	±0.7
20 GHz to 24 GHz	±0.7
24 GHz to 26.5 GHz	±0.6
26.5 GHz to 32 GHz	±1.0
32 GHz to 40 GHz	±1.1
40 GHz to 50 GHz	±1.0
50 GHz to 60 GHz	±0.8
60 GHz to 67 GHz	±1.1
67 GHz to 70 GHz	±1.0
70 GHz to 75 GHz	±1.1
75 GHz to 80 GHz	±1.2
80 GHz to 100 GHz	±1.5
100 GHz to 110 GHz	±1.8
110 GHz to 120 GHz	±1.8
120 GHz to 125 GHz	±2.2

¹ Nominal preset power (-5 dBm).

² With PNA/PNA-X Option 205 or 425 installed and LFE disabled, applied to frequencies ≤100 MHz. Above 100 MHz, performance is the same for both LFE enabled or disabled. For LFE enabled performance ≤100 MHz, see Table 8.

Table 8. Port Power Level Accuracy¹ (dB), All Ports, All Options (LFE Enabled)

Description	Typical
500 Hz to 900 Hz	±0.3
900 Hz to 1 kHz	±0.3
1 kHz to 10 kHz	±0.3
10 kHz to 100 kHz	±0.3
100 kHz to 1 MHz	±0.3
1 MHz to 5 MHz	±0.4
5 MHz to 10 MHz	±0.4
10 MHz to 50 MHz	±0.4
50 MHz to 100 MHz	±0.4

¹ Nominal preset power (-5 dBm).

Port Power Linearity

NOTE

Port power linearity listed is a receiver based measurement and absolute linearity may be better than shown.

Table 9. Port Power Linearity¹ (dB), All Ports, Option 201, 202, 401, 402, 403

Description	Typical
	-25 dBm to Max Power
10 MHz to 50 MHz ^{2,3}	≤±0.5
50 MHz to 500 MHz ^{2,3}	≤±0.5
500 MHz to 1 GHz ^{2,3}	≤±0.5
1 GHz to 2 GHz ^{2,3}	≤±0.5
2 GHz to 24 GHz ²	≤±0.5
24 GHz to 64 GHz	≤±0.5
64 GHz to 120 GHz	≤±0.5
120 GHz to 125 GHz	≤±0.5

¹ Referenced to nominal power (-5 dBm), from -25 dBm to max power.

² With PNA/PNA-X Option 205 or 425 installed and LFE disabled, applied to frequencies ≤100 MHz. Above 100 MHz, performance is the same for both LFE enabled or disabled. For LFE enabled performance ≤100 MHz, see Table 10.

³ For Option 401, 402, 403, Port 1 and Port 3, referenced to nominal power (-5 dBm), from -25 dBm to max power minus 3 dB.

Table 10. Power Level Linearity¹ (dB), All Ports (LFE Enabled)

Description	Specification	Typical
500 Hz to 900 Hz	--	±0.3
900 Hz to 1 kHz	±1.0	±0.2
1 kHz to 10 kHz	±1.0	±0.2
10 kHz to 100 kHz	±1.0	±0.2
100 kHz to 1 MHz	±1.0	±0.2
1 MHz to 5 MHz	±1.0	±0.2
5 MHz to 10 MHz	±1.0	±0.2
10 MHz to 50 MHz	±1.0	±0.2
50 MHz to 100 MHz	±1.0	±0.3

¹ Referenced to nominal power (-5 dBm), from -25 dBm to max power.

Port Harmonics

Table 11. Harmonics, All Options – Typical

Description ¹	2 nd Harmonic	3 rd Harmonic Ports 1, 3 ²	3 rd Harmonic Ports 2, 4 ²
10 MHz to 50 MHz ³	-20	-27	-22
50 MHz to 100 MHz ³	-23	-27	-23
100 MHz to 500 MHz	-19	-27	-23
500 MHz to 1 GHz	-17	-32	-23
1 GHz to 2 GHz	-20	-33	-23
2 GHz to 5 GHz	-25	-33	-23
5 GHz to 20 GHz	-26	-34	-22
20 GHz to 24 GHz	-46	-40	-32
24 GHz to 26.5 GHz	-42	-42	-32
26.5 GHz to 32 GHz	-44	-61	-32
32 GHz to 40 GHz	-44	-61	-45
40 GHz to 50 GHz	-43	--	--
50 GHz to 60 GHz	-42	--	--
60 GHz to 67 GHz	-36	--	--
67 GHz to 70 GHz	-31	--	--
70 GHz to 75 GHz	--	--	--
75 GHz to 80 GHz	--	--	--
80 GHz to 100 GHz	--	--	--
100 GHz to 110 GHz	--	--	--
110 GHz to 120 GHz	--	--	--
120 GHz to 125 GHz	--	--	--

¹ Listed frequency is fundamental frequency; test at max specified power.

² Any port can be used as the source port. Source in Filtered mode where applicable.

³ With PNA/PNA-X Option 205 or 425 installed and LFE disabled, applied to frequencies ≤100 MHz. Above 100 MHz, performance is the same for both LFE enabled or disabled. For LFE enabled performance ≤100 MHz, see Table 12.

Table 12. 2nd and 3rd Harmonics at Max Specified Power (dBc), All Ports – Typical (LFE Enabled)

Listed frequency is fundamental frequency; test at max specified power

Description	2 nd Harmonic	3 rd Harmonic
500 Hz to 900 Hz	-29	-27
900 Hz to 1 kHz	-22	-23
1 kHz to 10 kHz	-22	-23
10 kHz to 100 kHz	-22	-23
100 kHz to 1 MHz	-29	-22
1 MHz to 5 MHz	-33	-26
5 MHz to 10 MHz	-26	-22
10 MHz to 33 MHz	-22	-15
33 MHz to 50 MHz	-22	--

Source Phase Noise**Table 13. Phase Noise (dBc/Hz), All Options – Typical**

Description	1 kHz Offset	10 kHz Offset	100 kHz Offset	1 MHz Offset	10 MHz Offset
1 GHz	-107	-112	-111	-127	-129
3 GHz	-98	-104	-100	-123	-132
10 GHz	-89	-93	-89	-113	-130
20 GHz	-83	-87	-83	-107	-128
50 GHz	-72	-79	-73	-96	-117
80 GHz	-70	-75	-70	-95	-115
110 GHz	-67	-72	-67	-91	-112
125 GHz	-66	-72	-67	-90	-105

Table 14. Phase Noise (dBc/Hz), All Ports – Typical (LFE Enabled)

Description	1 kHz Offset	10 kHz Offset	100 kHz Offset	1 MHz Offset
500 Hz to 100 MHz	-120	-130	-125	-135

Test Port Input – 500 Hz to 125 GHz

Noise Floor

Table 15. Test Port Noise Floor (dBm) @ 10 Hz IFBW, All Options

Description	Specification	Typical
10 MHz to 50 MHz ¹	-66	-82
50 MHz to 100 MHz ¹	-82	-95
100 MHz to 500 MHz	-91	-107
500 MHz to 1 GHz	-104	-115
1 GHz to 2 GHz	-110	-119
2 GHz to 2.5 GHz	-114	-119
2.5 GHz to 3.2 GHz	-115	-119
3.2 GHz to 5 GHz	-115	-119
5 GHz to 8 GHz	-115	-120
8 GHz to 10 GHz	-115	-120
10 GHz to 12 GHz	-115	-120
12 GHz to 13.5 GHz	-115	-120
13.5 GHz to 15 GHz	-115	-120
15 GHz to 16 GHz	-115	-120
16 GHz to 18 GHz	-115	-120
18 GHz to 20 GHz	-115	-120
20 GHz to 24 GHz	-113	-120
24 GHz to 26.5 GHz	-113	-120
26.5 GHz to 30 GHz	-107	-112
30 GHz to 35 GHz	-107	-112
35 GHz to 40 GHz	-107	-112
40 GHz to 45 GHz	-107	-112
45 GHz to 50 GHz	-106	-112
50 GHz to 60 GHz	-108	-113
60 GHz to 64 GHz	-108	-113
64 GHz to 67 GHz	-108	-114
67 GHz to 70 GHz	-108	-114
70 GHz to 75 GHz	-105	-113
75 GHz to 80 GHz	-103	-109
80 GHz to 85 GHz	-103	-110
85 GHz to 90 GHz	-103	-110
90 GHz to 95 GHz	-103	-111
95 GHz to 100 GHz	-103	-110
100 GHz to 105 GHz	-100	-107
105 GHz to 110 GHz	-101	-108
110 GHz to 115 GHz	-95	-108
115 GHz to 120 GHz	-94	-103
120 GHz to 125 GHz	--	-101

¹ With PNA/PNA-X Option 205 or 425 installed and LFE disabled, applied to frequencies ≤100 MHz. Above 100 MHz, performance is the same for both LFE enabled or disabled. For LFE enabled performance ≤100 MHz, see Table 16.

Table 16. Test Port Noise Floor (dBm) @ 10 Hz IFBW, All Options (LFE Enabled)

Description	Specification	Typical
500 Hz to 900 Hz	--	-88
900 Hz to 1 kHz	-84	-92
1 kHz to 10 kHz	-85	-93
10 kHz to 100 kHz	-98	-104
100 kHz to 1 MHz	-102	-108
1 MHz to 5 MHz	-103	-110
5 MHz to 10 MHz	-95	-101
10 MHz to 50 MHz	-95	-101
50 MHz to 100 MHz	-95	-101

Trace Noise

Table 17. Trace Noise, Magnitude (dB rms), All Options

Description	Specification	Typical		
		1 kHz IFBW	100 kHz IFBW	600 kHz IFBW
10 MHz to 50 MHz ¹	0.2	0.073	0.735	1.770
50 MHz to 100 MHz ¹	0.02	0.012	0.12	0.26
100 MHz to 200 MHz	0.007	0.003	0.031	0.076
200 MHz to 1 GHz	0.005	0.002	0.018	0.046
1 GHz to 26.5 GHz	0.003	0.000	0.004	0.009
26.5 GHz to 67 GHz	0.004	0.001	0.008	0.020
67 GHz to 75 GHz	0.004	0.001	0.007	0.016
75 GHz to 110 GHz	0.005	0.001	0.011	0.027
110 GHz to 120 GHz	0.006	0.002	0.018	0.043
120 GHz to 125 GHz	--	0.004	0.038	0.093

¹ With PNA/PNA-X Option 205 or 425 installed and LFE disabled, applied to frequencies ≤100 MHz. Above 100 MHz, performance is the same for both LFE enabled or disabled. For LFE enabled performance ≤100 MHz, see Table 18.

Table 18. Trace Noise, Magnitude¹ (dB rms), All Ports, All Options (LFE Enabled)

Description	Specification		Typical			
	100 Hz IFBW	1 kHz IFBW	100 Hz IFBW	1 kHz IFBW	100 kHz IFBW	600 kHz IFBW
500 Hz to 900 Hz	--	--	0.002	--	--	--
900 Hz to 4 kHz	0.004	--	0.001	--	--	--
4 kHz to 300 kHz	--	0.004	--	0.002	--	--
300 kHz to 2 MHz	--	0.004	--	0.001	0.01	--
2 MHz to 100 MHz	--	0.004	--	0.002	0.017	0.041

¹ Ratioed measurement, nominal power at test port.

Table 19. Trace Noise, Phase (deg rms), All Ports, All Options

Description	Specification		Typical		
	1 kHz IFBW		1 kHz IFBW	100 kHz IFBW	600 kHz IFBW
10 MHz to 50 MHz ¹	1.50		0.556	4.90	11.9
50 MHz to 100 MHz ¹	0.14		0.083	0.83	1.89
100 MHz to 200 MHz	0.080		0.023	0.205	0.514
200 MHz to 1 GHz	0.050		0.014	0.125	0.309
1 GHz to 26.5 GHz	0.050		0.005	0.024	0.060
26.5 GHz to 67 GHz	0.080		0.008	0.060	0.144
67 GHz to 75 GHz	0.100		0.012	0.049	0.116
75 GHz to 110 GHz	0.100		0.013	0.085	0.205
110 GHz to 120 GHz	0.100		0.018	0.138	0.324
120 GHz to 125 GHz	--		0.037	0.316	0.735

¹ With PNA/PNA-X Option 205 or 425 installed and LFE disabled, applied to frequencies ≤100 MHz. Above 100 MHz, performance is the same for both LFE enabled or disabled. For LFE enabled performance ≤100 MHz, see Table 20.

Table 20. Trace Noise, Phase¹ (deg rms), All Ports, All Options (LFE Enabled)

Description	Specification		Typical			
	100 Hz IFBW	1 kHz IFBW	100 Hz IFBW	1 kHz IFBW	100 kHz IFBW	600 kHz IFBW
500 Hz to 900 Hz	--	--	0.016	--	--	--
900 Hz to 4 kHz	0.035	--	0.01	--	--	--
4 kHz to 300 kHz	--	0.035	--	0.016	--	--
300 kHz to 2 MHz	--	0.035	--	0.006	0.061	--
2 MHz to 100 MHz	--	0.035	--	0.011	0.106	0.258

¹ Ratioed measurement, nominal power at test port.

Compression

Table 21. Compression¹, All Ports - Typical

Description	Test Port Power (dBm)	Receiver Compression	
	All Options	Magnitude (dB)	Phase (degrees)
10 MHz to 50 MHz ²	+5	0.04	0.2
50 MHz to 100 MHz ²	+5	0.05	0.3
100 MHz to 500 MHz	+5	0.05	0.3
500 MHz to 1 GHz	+5	0.04	0.1
1 GHz to 2 GHz	+5	0.04	0.1
2 GHz to 5 GHz	+5	0.05	0.1
5 GHz to 10 GHz	+5	0.05	0.1
10 GHz to 20 GHz	+5	0.05	0.2
20 GHz to 24 GHz	+5	0.05	0.4
24 GHz to 26.5 GHz	+5	0.05	0.4
26.5 GHz to 32 GHz	+5	0.05	0.4
32 GHz to 40 GHz	+5	0.05	0.4
40 GHz to 50 GHz	+5	0.05	0.4
50 GHz to 60 GHz	+5	0.05	0.4
60 GHz to 64 GHz	+5	0.05	0.4
64 GHz to 67 GHz	+5	0.05	0.4
67 GHz to 70 GHz	+5	0.09	1.1
70 GHz to 75 GHz	+5	0.09	1.1
75 GHz to 80 GHz	+5	0.10	1.2
80 GHz to 90 GHz	+5	0.16	2.0
90 GHz to 100 GHz	+5	0.17	2.0
100 GHz to 110 GHz	+5	0.17	2.0
110 GHz to 115 GHz	+5	0.15	2.0
115 GHz to 120 GHz	0	0.10	1.0
120 GHz to 125 GHz	0	0.10	1.0

¹Data represents the transmission compression with a negligible level of compression in the Reference Receivers.

² With PNA/PNA-X Option 205 or 425 installed and LFE disabled, applied to frequencies ≤ 100 MHz. Above 100 MHz, performance is the same for both LFE enabled or disabled. For LFE enabled performance ≤ 100 MHz, see Table 22.

Table 22. Compression, All Ports (LFE Enabled) - Typical

Description	Test Port Power (dBm)	Receiver Compression	
	All Options	Magnitude (dB)	Phase (degrees)
500 Hz to 900 Hz	4	0.13	1.29
900 Hz to 1 kHz	4	0.09	0.52
1 kHz to 10 kHz	8	0.06	0.37
10 kHz to 100 kHz	8	0.06	0.37
100 kHz to 1 MHz	10	0.03	0.14
1 MHz to 5 MHz	7	0.04	0.10
5 MHz to 10 MHz	3	0.03	0.15
10 MHz to 50 MHz	3	0.03	0.15
50 MHz to 100 MHz	3	0.02	0.17

Table 23. 0.1 dB Compression, All Ports, All Options - Typical

Description	Test Port Power (dBm)
10 MHz to 50 MHz ¹	10
50 MHz to 100 MHz ¹	10
100 MHz to 500 MHz	10
500 MHz to 1 GHz	10
1 GHz to 2 GHz	9
2 GHz to 5 GHz	8
5 GHz to 10 GHz	8
10 GHz to 20 GHz	8
20 GHz to 24 GHz	7
24 GHz to 26.5 GHz	8
26.5 GHz to 32 GHz	7
32 GHz to 40 GHz	7
40 GHz to 50 GHz	7
50 GHz to 60 GHz	8
60 GHz to 64 GHz	9
64 GHz to 67 GHz	6
67 GHz to 70 GHz	6
70 GHz to 75 GHz	6
75 GHz to 80 GHz	5
80 GHz to 90 GHz	4
90 GHz to 100 GHz	2
100 GHz to 110 GHz	1
110 GHz to 120 GHz	0
120 GHz to 125 GHz	0

¹ With PNA/PNA-X Option 205 or 425 installed and LFE disabled, applied to frequencies ≤100 MHz. Above 100 MHz, performance is the same for both LFE enabled or disabled. For LFE enabled performance ≤100 MHz, see Table 24.

Table 24. 0.1 dB Compression, All Ports, All Options (LFE Enabled) - Typical

Description	Test Port Power (dBm)
500 Hz to 900 Hz	13
900 Hz to 1 kHz	13
1 kHz to 10 kHz	13
10 kHz to 100 kHz	13
100 kHz to 1 MHz	13
1 MHz to 5 MHz	11
5 MHz to 10 MHz	13
10 MHz to 50 MHz	14
50 MHz to 100 MHz	14

Damage Input Level

Table 25. Damage Input Level, All Options

Description	1 mm Test Port		BNC Bias Port	
	RF (dBm)	DC (V)	DC (V)	Max Current (A)
All Options	>20	>50	>50	>1

Bias Tee Leakage Current

Table 26. Leakage Current (Average Typical)

Description	
Leakage Current	<18 nA

NOTE Leakage current measured with test port open circuit and is typical.

NOTE When using the bias-tees on N5295AX03/53 frequency extender modules, users may see errors for measurements below 100 MHz. This is due to the interaction between the built-in LFE bias combiner and the output match of the DC-bias supply being used.

Dynamic Accuracy

Dynamic accuracy is verified with the following measurements:

1. Compression over frequency.
2. IF linearity at a single frequency of 99.6 MHz using a reference level of -20 dBm for an input power range of +4 to -55 dBm.

For values below -55 dBm, refer to “[VNA Receiver Dynamic Accuracy Specifications and Uncertainties](#)”.

Table 27. N5291A Dynamic Accuracy, 900 Hz (LFE Enabled) - Specification

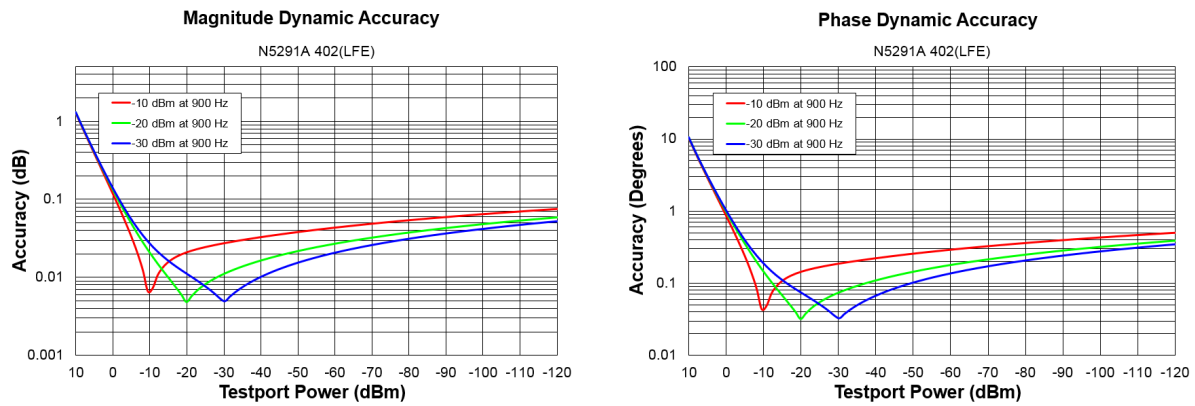

Table 28. N5291A Dynamic Accuracy, 10 MHz (LFE Enabled) - Specification

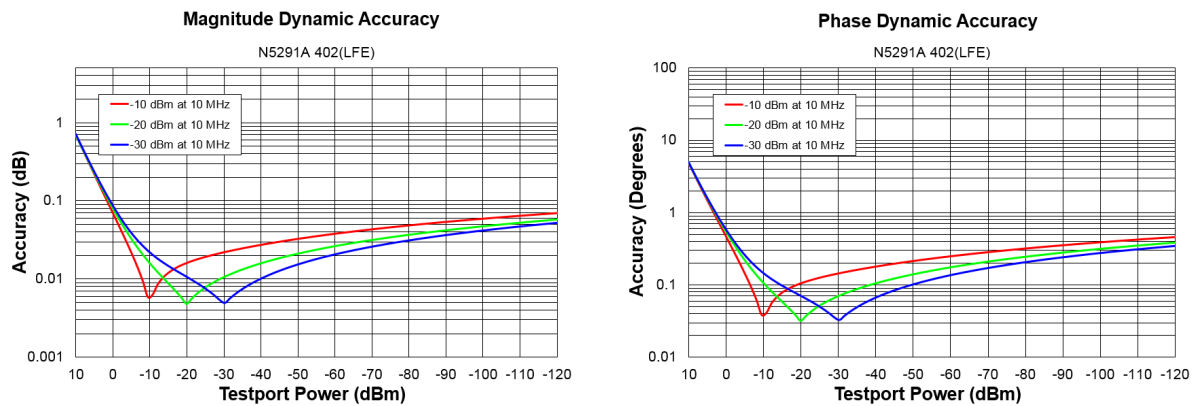

Table 29. N5291A Dynamic Accuracy, 100 MHz (LFE Enabled) - Specification

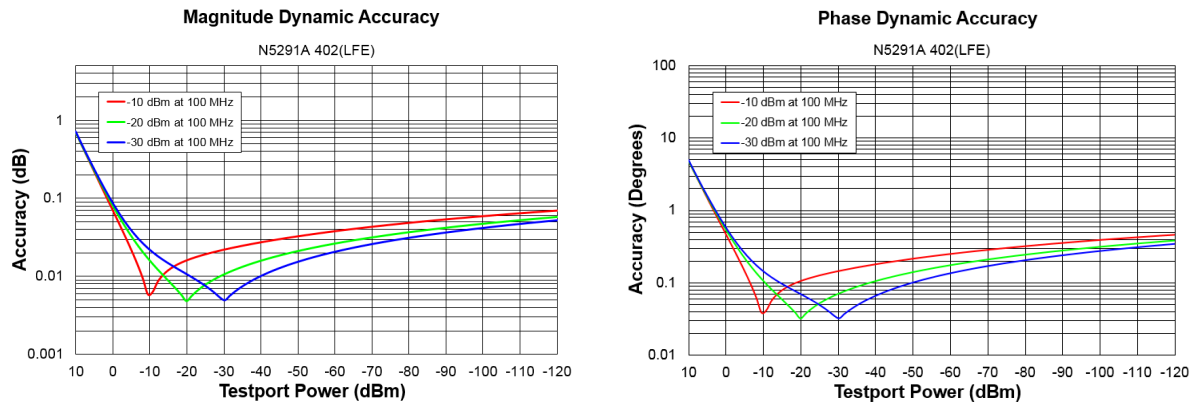

Table 30. N5291A Dynamic Accuracy, 1 GHz - Specification

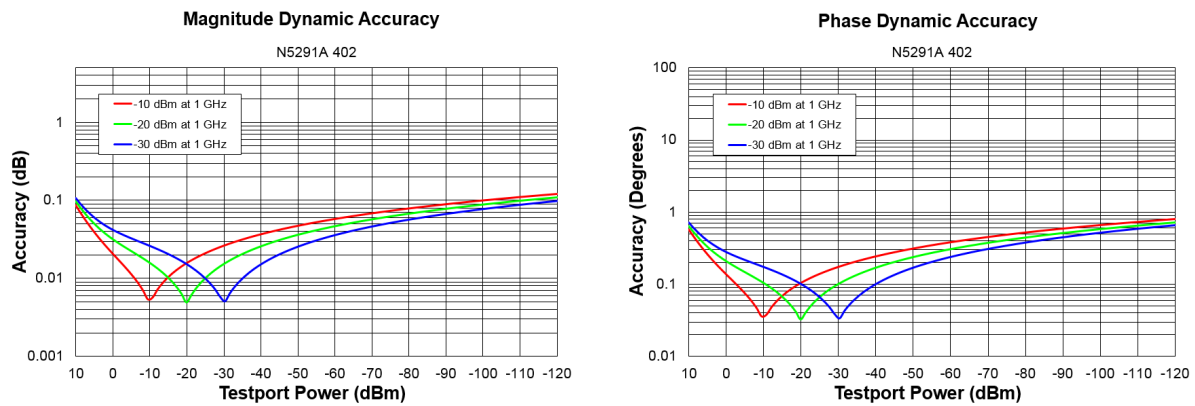

Table 31. N5291A Dynamic Accuracy, 26.5 GHz - Specification

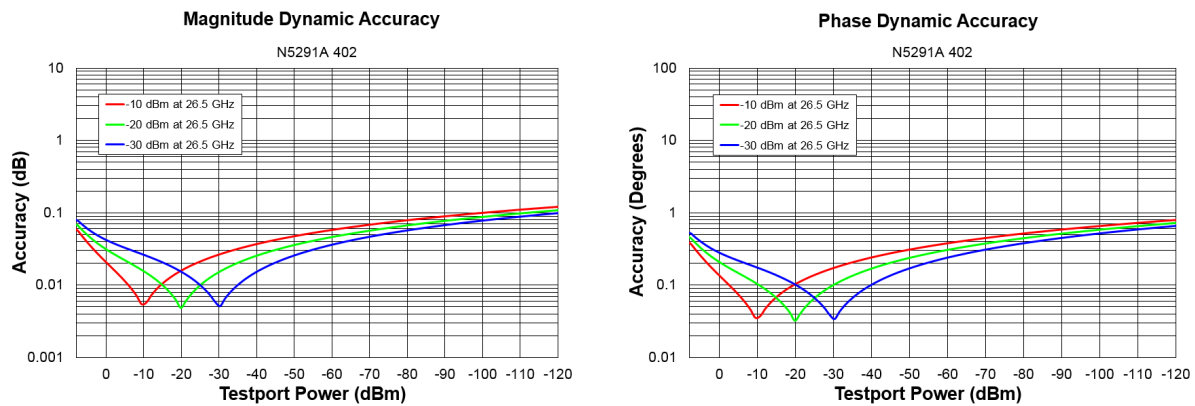

Table 32. N5291A Dynamic Accuracy, 50 GHz - Specification

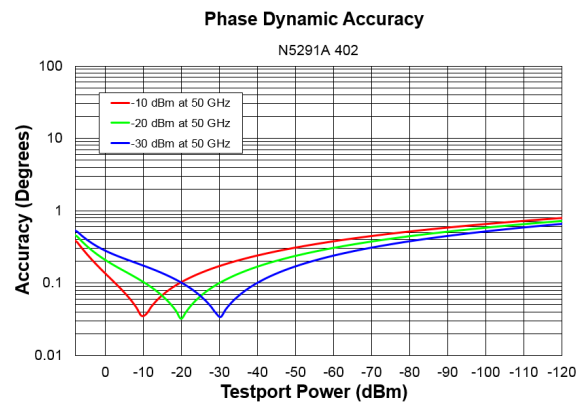
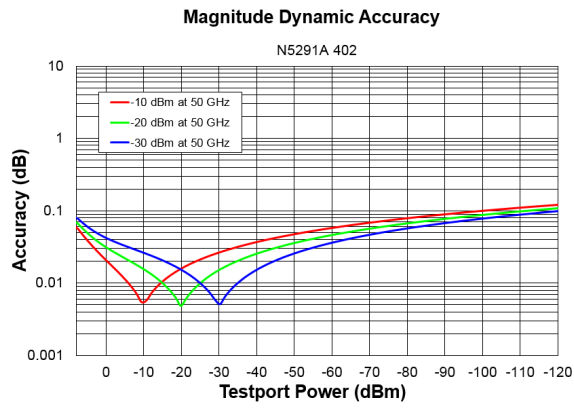

Table 33. N5291A Dynamic Accuracy, 67 GHz - Specification

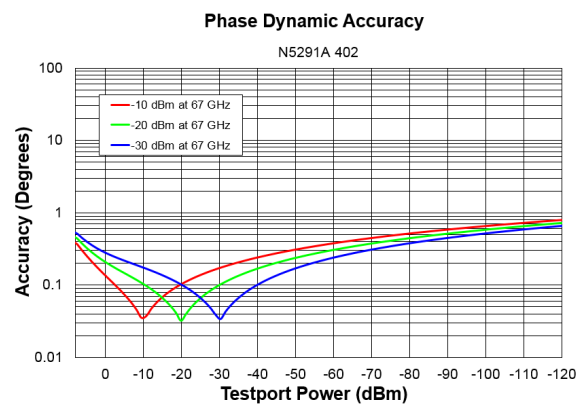
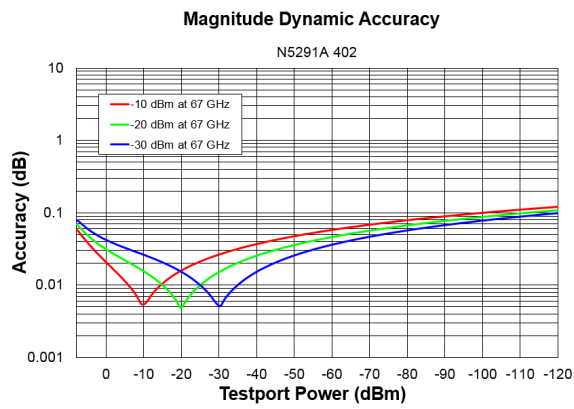

Table 34. N5291A Dynamic Accuracy, 110 GHz - Specification

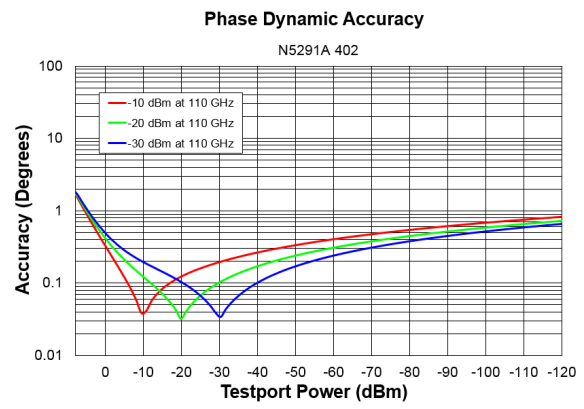
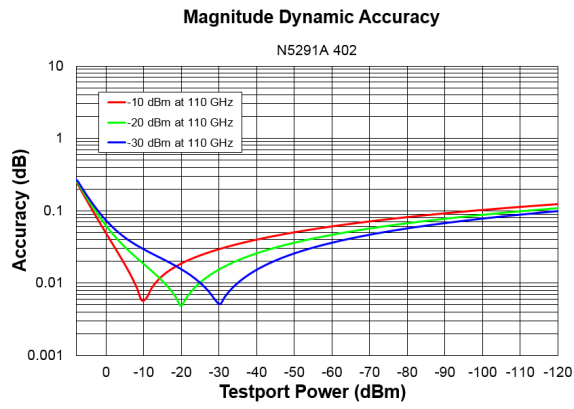
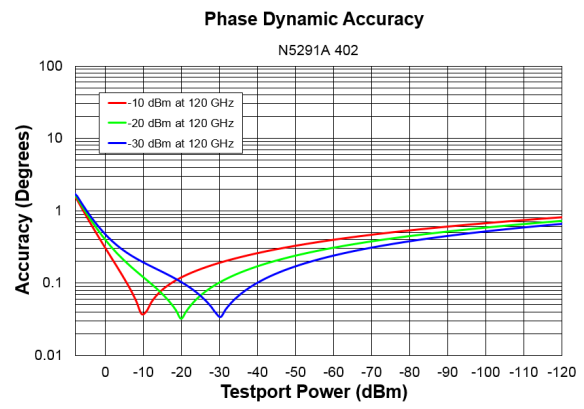
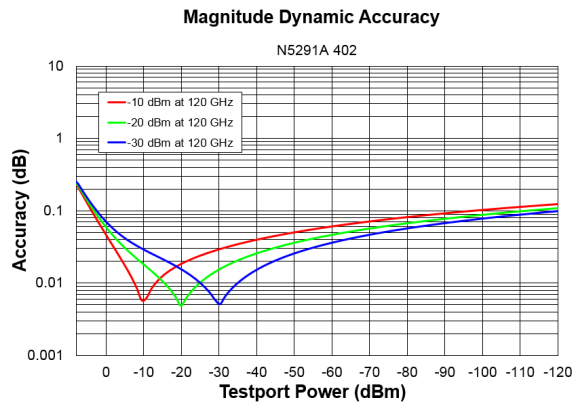

Table 35. N5291A Dynamic Accuracy, 120 GHz – Specification



Group Delay - Typical

Group delay is computed by measuring the phase change within a specified frequency step (determined by the frequency span and the number of points per sweep). In general, the following formula can be used to determine the accuracy, in seconds, of specific group delay measurement:

$$\pm \text{Phase Accuracy (deg)} / [360 \times \text{Aperture (Hz)}]$$

Depending on the aperture and device length, the phase accuracy used is either incremental phase accuracy or worst-case phase accuracy.

Table 36. Group Delay - Typical

Description	Typical Performance
Aperture (selectable)	(frequency span)/(number of points -1)
Maximum Aperture	20% of frequency span
Range	0.5 x (1/minimum aperture)
Maximum Delay	Limited to measuring no more than 180° of phase change within the minimum aperture.)

The following graph shows characteristic group delay accuracy with full 2-port calibration and a 10 Hz IF bandwidth. Insertion loss is assumed to be < 2 dB and electrical length to be ten meters.

For any S_{ij} Group Delay measurement, $S_{ii} = 0$, $S_{ij} = 1$, $S_{ji} = 0$, $S_{kl} = 0$ for all $kl \neq ij$

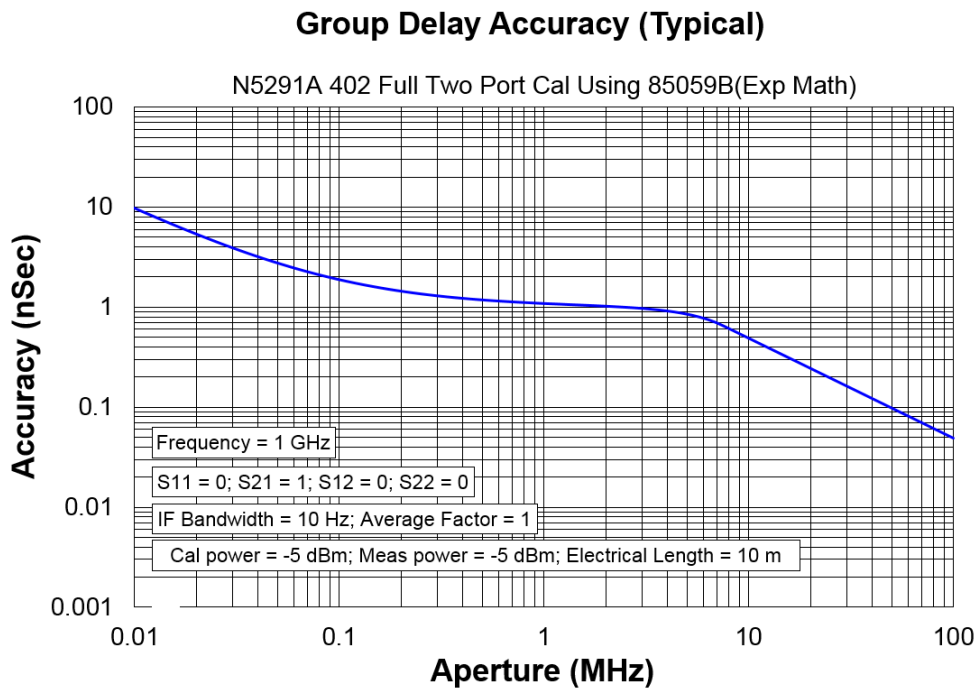

N5291A Stability

Transmission Magnitude Stability (Nominal)

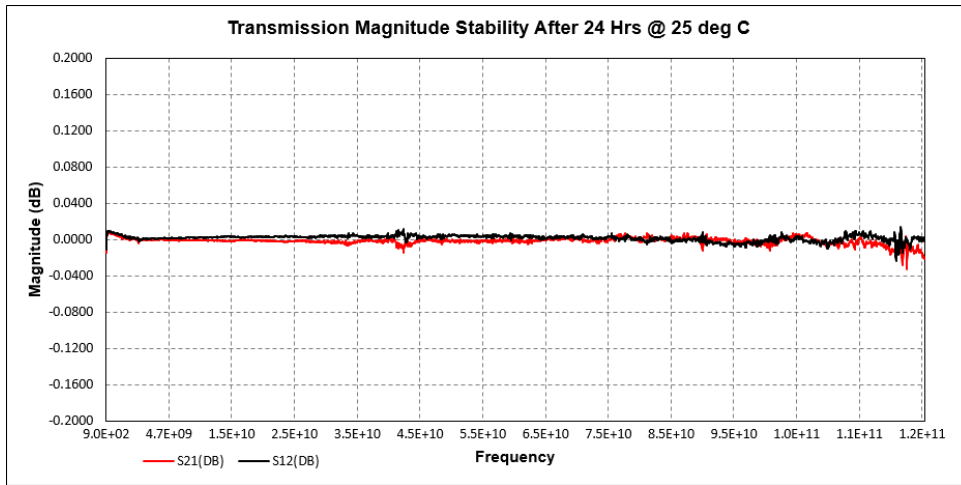

Transmission Phase Stability (Nominal)

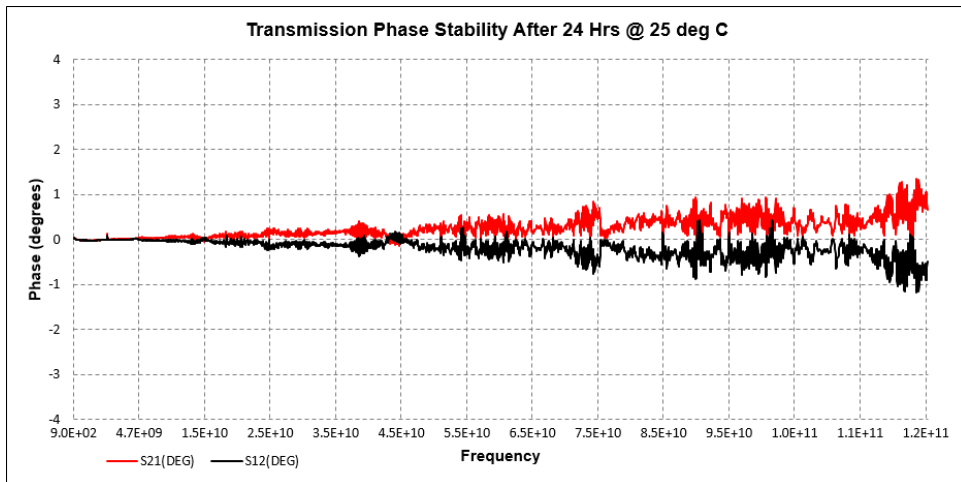

Reflection Magnitude Stability (Nominal)

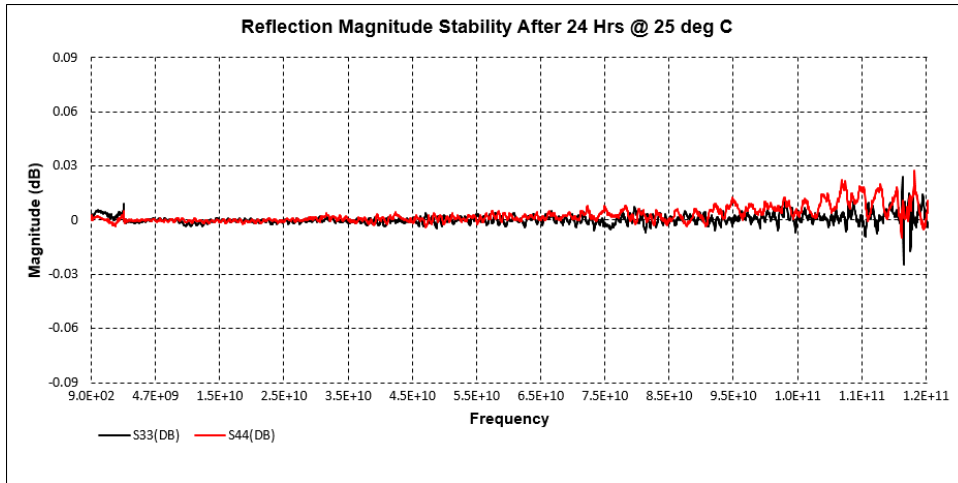

Reflection Phase Stability (Nominal)

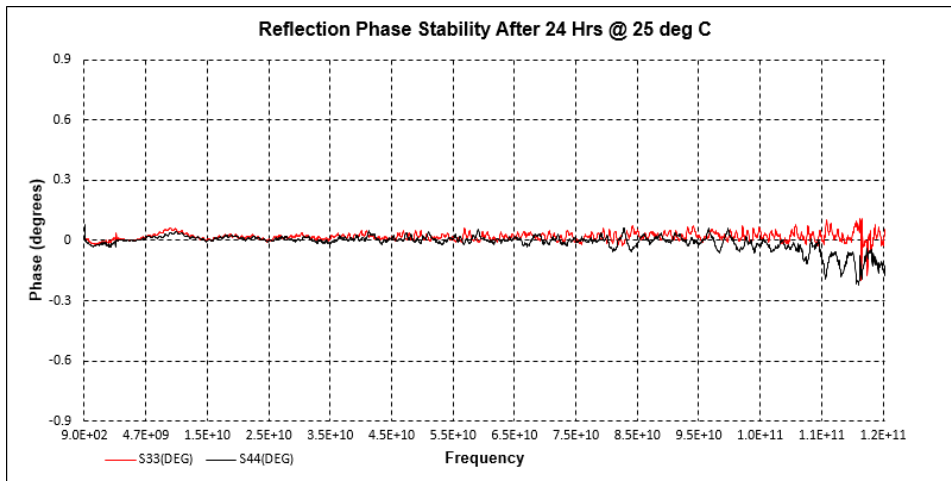

Table 37. N5291A Stability – Typical (10 MHz to 125 GHz) (LFE Disabled)

Description	Magnitude (dB/°C)	Phase (°/°C)
10 MHz to 2.5 GHz	0.01	0.02
2.5 GHz to 24 GHz	0.01	0.03
24 GHz to 54 GHz	0.01	0.10
54 GHz to 80 GHz	0.01	0.20
80 GHz to 110 GHz	0.015	0.25
110 GHz to 120 GHz	0.03	0.40
120 GHz to 125 GHz	0.04	0.50

Table 38. Receiver Stability (LFE Enabled) - Typical

Description	Magnitude (dB/°C)	Phase (°/°C)
500 Hz to 900 Hz	0.015	0.15
900 Hz to 1 kHz	0.015	0.15
1 kHz to 10 kHz	0.015	0.15
10 kHz to 100 kHz	0.015	0.15
100 kHz to 1 MHz	0.015	0.15
1 MHz to 5 MHz	0.03	0.3
5 MHz to 10 MHz	0.1	0.3
10 MHz to 50 MHz	0.1	0.3
50 MHz to 100 MHz	0.1	0.55

Uncorrected System Performance

Table 39. Error Terms (dB), All Ports, All Options – Specification

Description	Directivity	Source Match	Load Match
10 MHz to 50 MHz ¹	18	8	8
50 MHz to 200 MHz ¹	20	17	5
200 MHz to 500 MHz	19	16	5
500 MHz to 2 GHz	18	15	5
2 GHz to 3.2 GHz	18	15	10
3.2 GHz to 10 GHz	15	13	8
10 GHz to 13.5 GHz	14	12	9
13.5 GHz to 16 GHz	14	12	9
16 GHz to 20 GHz	11	12	7
20 GHz to 24 GHz	11	12	8
24 GHz to 26.5 GHz	11	7	7
26.5 GHz to 40 GHz	8	7	5
40 GHz to 43.5 GHz	6	5	7
43.5 GHz to 50 GHz	5	4	6
50 GHz to 60 GHz	5	4	5
60 GHz to 64 GHz	5	4	6
64 GHz to 67 GHz	5	4	5
67 GHz to 75 GHz	4	4	6
75 GHz to 100 GHz	2	3	6
100 GHz to 110 GHz	0	3	4
110 GHz to 120 GHz	0	2	3

¹ With PNA/PNA-X Option 205 or 425 installed and LFE disabled, applied to frequencies ≤ 100 MHz. Above 100 MHz, performance is the same for both LFE enabled or disabled. For LFE enabled performance ≤ 100 MHz, see Table 40 and Table 42.

Table 40. Error Terms (dB), All Ports, All Options – Specification (LFE Enabled)

Description	Directivity	Source Match	Load Match
900 Hz to 1 kHz	-8	4	4
1 kHz to 10 kHz	-7	5	5
10 kHz to 1 MHz	12	16	14
1 MHz to 5 MHz	6	10	9
5 MHz to 50 MHz	-3	8	8
50 MHz to 100 MHz	-5	7	7

Table 41. Error Terms (dB), All Ports, All Options – Typical

Description	Directivity	Source Match	Load Match	Transmission Tracking	Reflection Tracking	Crosstalk
10 MHz to 50 MHz ¹	25	17	10	±1.5	±1.5	-80
50 MHz to 200 MHz ¹	26	24	7	±1.5	±1.5	-102
200 MHz to 500 MHz	26	25	7	±1.5	±1.5	-113
500 MHz to 2 GHz	23	23	7	±1.5	±1.5	-116
2 GHz to 3.2 GHz	25	25	13	±1.5	±1.5	-125
3.2 GHz to 10 GHz	22	22	11	±1.5	±1.5	-125
10 GHz to 13.5 GHz	28	20	13	±1.5	±1.5	-125
13.5 GHz to 16 GHz	19	21	13	±1.5	±1.5	-125
16 GHz to 20 GHz	16	19	11	±1.75	±1.5	-125
20 GHz to 24 GHz	18	19	11	±1.5	±1.5	-125
24 GHz to 26.5 GHz	16	19	10	±1.5	±1.5	-125
26.5 GHz to 40 GHz	11	15	10	±1.5	±1.5	-119
40 GHz to 43.5 GHz	11	10	12	±1.5	±1.5	-119
43.5 GHz to 50 GHz	10	9	10	±1.75	±1.5	-119
50 GHz to 60 GHz	9	10	10	±1.75	±1.5	-119
60 GHz to 64 GHz	9	10	11	±1.75	±1.5	-119
64 GHz to 67 GHz	11	11	10	±1.75	±1.5	-119
67 GHz to 75 GHz	9	10	11	±1.75	±1.5	-119
75 GHz to 100 GHz	7	11	11	±1.75	±1.5	-118
100 GHz to 110 GHz	5	10	9	±2	±1.5	-116
110 GHz to 120 GHz	6	9	7	±2	±1.5	-109
120 GHz to 125 GHz	2	8	7	±2.5	±1.5	-102

¹ With PNA/PNA-X Option 205 or 425 installed and LFE disabled, applied to frequencies ≤100 MHz. Above 100 MHz, performance is the same for both LFE enabled or disabled. For LFE enabled performance ≤100 MHz, see Table 40 and Table 42.

Table 42. Error Terms (dB), All Ports, All Options – Typical (LFE Enabled)

Description	Directivity	Source Match	Load Match	Transmission Tracking	Reflection Tracking	Crosstalk
500 Hz to 900 Hz	-13	3	3	±1.5	±1.5	-92
900 Hz to 1 kHz	-6	5	6	±1.5	±1.5	-99
1 kHz to 10 kHz	-4	6	6	±1.5	±1.5	-94
10 kHz to 100 kHz	15	20	18	±1.5	±1.5	-99
100 kHz to 1 MHz	15	20	18	±1.5	±1.5	-116
1 MHz to 5 MHz	11	11	11	±1.5	±1.5	-117
5 MHz to 10 MHz	2	9	9	±1.5	±1.5	-111
10 MHz to 50 MHz	2	9	9	±1.5	±1.5	-105
50 MHz to 100 MHz	-2	9	9	±1.5	±1.5	-108

Corrected System Performance

For any Sii reflection measurement:

- $S_{jj} = 0$.

For any Sij transmission measurement:

- $S_{ji} = S_{ij}$ when $S_{ij} \leq 1$
- $S_{ji} = 1/S_{ij}$ when $S_{ij} > 1$
- $S_{kk} = 0$ for all k

Applies to the N5291A Option 201, 202, 401, 402, or 403 systems using the 85059B calibration kit. Also applies to the following condition:

Environmental temperature $23^\circ \pm 3^\circ \text{C}$, with $< 1^\circ \text{C}$ deviation from calibration temperature

Please download our free Uncertainty Calculator from http://www.keysight.com/find/na_calculator to generate the curves for your calibration kit and system setup.

N5291A System (10 MHz to 120 GHz) (LFE Disabled)

Table 43. Error Terms (dB), All Ports, All Options – Specifications

	Directivity	Source Match	Load Match	Transmission Tracking		Reflection Tracking	
				Mag	Phase ($^\circ$)	Mag	Phase ($^\circ$)
10 MHz to 50 MHz ¹	29	28	29	± 0.260	± 1.713	± 0.020	± 0.132
50 MHz to 200 MHz ¹	29	28	29	± 0.236	± 1.560	± 0.020	± 0.132
200 MHz to 500 MHz	29	28	29	± 0.242	± 1.595	± 0.020	± 0.132
500 MHz to 2 GHz	29	28	29	± 0.248	± 1.635	± 0.020	± 0.132
2 GHz to 3.2 GHz	29	28	29	± 0.164	± 1.081	± 0.020	± 0.132
3.2 GHz to 10 GHz	30	29	29	± 0.182	± 1.204	± 0.055	± 0.363
10 GHz to 13.5 GHz	31	31	30	± 0.155	± 1.023	± 0.090	± 0.594
13.5 GHz to 16 GHz	35	35	33	± 0.101	± 0.667	± 0.090	± 0.594
16 GHz to 20 GHz	36	35	34	± 0.107	± 0.708	± 0.070	± 0.462
20 GHz to 24 GHz	37	36	36	± 0.090	± 0.595	± 0.050	± 0.330
24 GHz to 26.5 GHz	37	36	36	± 0.097	± 0.643	± 0.050	± 0.330
26.5 GHz to 40 GHz	35	33	33	± 0.189	± 1.245	± 0.060	± 0.396
40 GHz to 43.5 GHz	33	32	32	± 0.222	± 1.463	± 0.070	± 0.462
43.5 GHz to 50 GHz	32	31	31	± 0.281	± 1.857	± 0.075	± 0.495
50 GHz to 60 GHz	31	30	29	± 0.343	± 2.265	± 0.115	± 0.759
60 GHz to 64 GHz	31	30	29	± 0.333	± 2.201	± 0.150	± 0.990
64 GHz to 67 GHz	31	30	28	± 0.355	± 2.345	± 0.150	± 0.990
67 GHz to 75 GHz	28	27	26	± 0.449	± 2.961	± 0.150	± 0.990
75 GHz to 100 GHz	27	27	26	± 0.483	± 3.190	± 0.120	± 0.792
100 GHz to 110 GHz	27	27	25	± 0.560	± 3.693	± 0.130	± 0.858
110 GHz to 120 GHz	27	27	25	± 0.633	± 4.177	± 0.130	± 0.858

¹ With PNA/PNA-X Option 205 or 425 installed and LFE disabled, applied to frequencies ≤ 100 MHz. Above 100 MHz, performance is the same for both LFE enabled or disabled. For LFE enabled performance ≤ 100 MHz, see Table 44.

Transmission Uncertainty, (LFE Disabled)

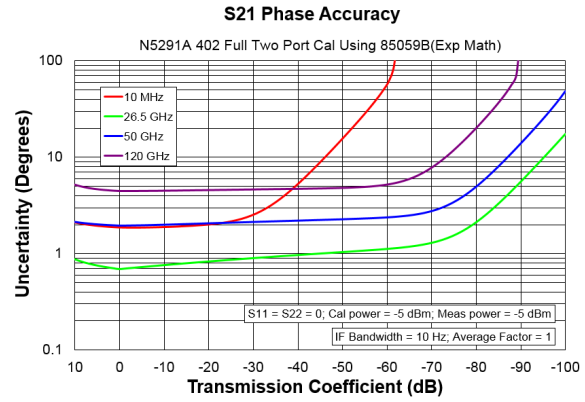
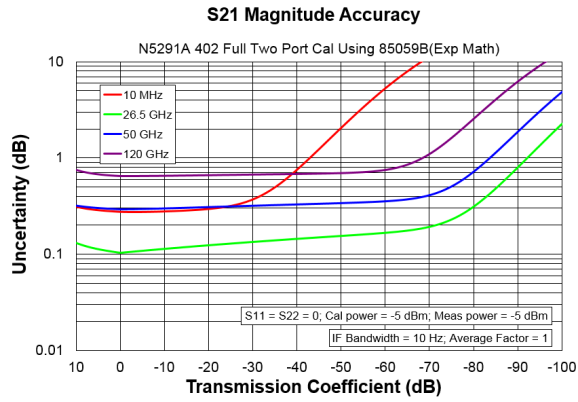

Reflection Uncertainty, (LFE Disabled)

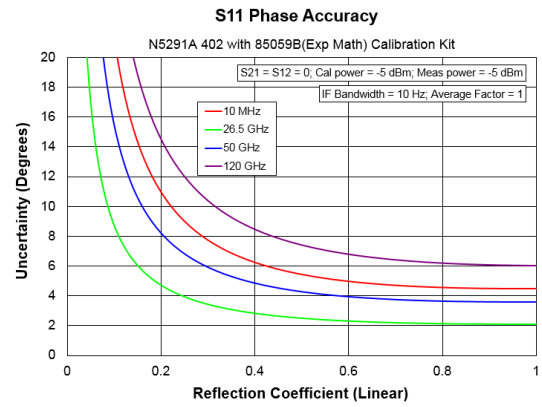
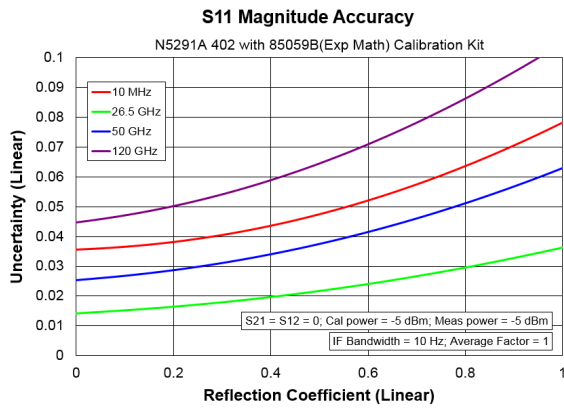

N5291A System (900 Hz to 100 MHz) (LFE Enabled)

Table 44. Error Terms (dB), All Ports, All Options – Specification (LFE Enabled)

	Directivity	Source Match	Load Match	Transmission Tracking		Reflection Tracking	
				Mag	Phase (°)	Mag	Phase (°)
900 Hz to 1 kHz	29	28	29	±0.490	±3.234	±0.020	±0.132
1 kHz to 10 kHz	29	28	29	±0.366	±2.417	±0.020	±0.132
10 kHz to 1 MHz	29	28	29	±0.206	±1.362	±0.020	±0.132
1 MHz to 5 MHz	29	28	29	±0.260	±1.713	±0.020	±0.132
5 MHz to 50 MHz	29	28	29	±0.291	±1.922	±0.020	±0.132
50 MHz to 100 MHz	29	28	29	±0.291	±1.922	±0.020	±0.132

Transmission Uncertainty, (LFE Enabled)

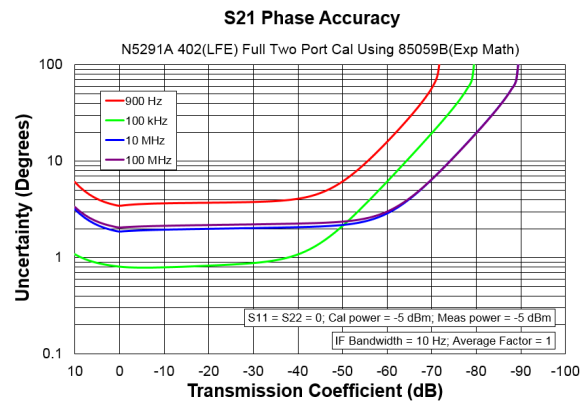
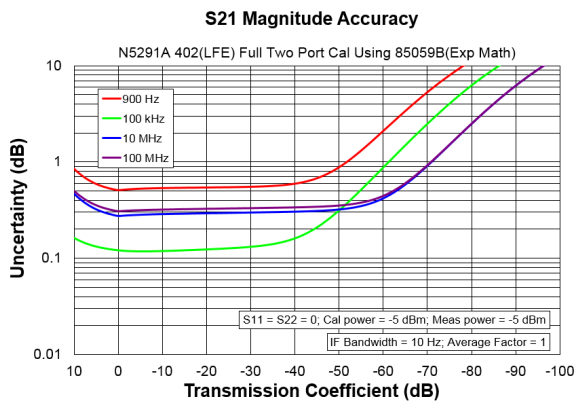

Reflection Uncertainty, (LFE Enabled)

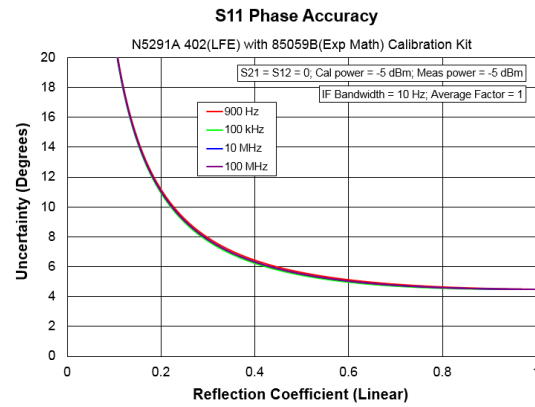
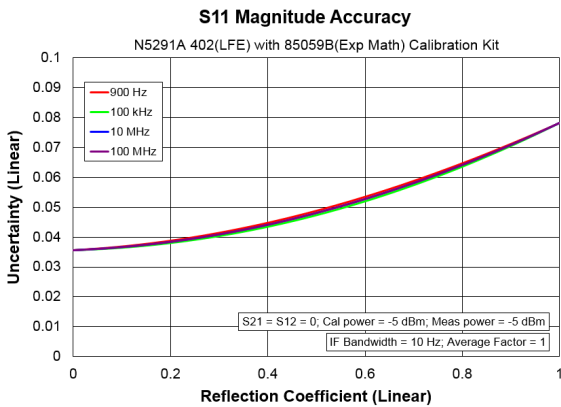

General Information

- [Miscellaneous Information](#)
- [N5295AXxx Frequency Extenders](#)
- [N5292A Test Set Front Panel](#)
- [N5292A Test Set Rear Panel](#)
- [VNA Front Panel Information, All Options](#)
- [System Dimensions and Weight](#)
- [Regulatory and Environmental Information](#)

Table 45. Miscellaneous Information

Description	Supplemental Information
System IF Bandwidth Range	1 Hz to 15 MHz, nominal
CPU	For the latest information on CPUs and associated hard drives, visit: http://na.support.keysight.com/pna/hdnumbers.html
LXI	Class C

Table 46. N5295AXxx Frequency Extenders

Description	Typical Performance
Connector	1 mm, male
Sense Connector	Lemo K connector, 2 contacts
BNC Bias Input	BNC, female
Cable/Connector	Integrated N5292A Test Set front port connector
LED States	Blue: Connected and addressed by N5292A Test Set Green: Standby Orange: Standby or warmup Red: Error condition Off: N5295AXxx is turned off
Max Bias Voltage ¹	50 VDC
Max Bias Current ¹	1 amp
Rise/fall time ²	<1 usec

¹ Applies to N5295AX02/52 and N5295AX03/53 frequency extenders.

² Applies to N5295AX02/52 frequency extenders.

Table 47. N5292A Test Set Front Panel

Description	Typical Performance
NA Src Out	3.5 mm, female
NA Port	3.5 mm, female
Integrated Connector	Integrated N5292A Test Set front port connector
IF Ref Out	3.5 mm, female
IF Test Out	3.5 mm, female

Table 48. N5292A Test Set Rear Panel

Description	Typical Performance
LO IN	Connected to LO OUT from VNA
IF OUTPUTS	SMA (female); A, B, C, D, R
Test Set I/O	25-pin D-Sub connector
Line Power	
Frequency, Voltage	50/60/400 Hz for 100 to 120 VAC 50/60 Hz for 220 to 240 VAC
Fuse	5 A/250 V

Table 49. VNA Front Panel Information, All Options

Description	Typical Performance
Display Range	
Magnitude	±2500 dB (at 500 dB/div), max
Phase	±2500° (at 500 dB/div), max
Polar	10 pUnits, min 10,000 Units, max
Display Resolution	
Magnitude	0.001 dB/div, min
Phase	0.01°/div, min
Marker Resolution	
Magnitude	0.001 dB, min
Phase	0.01°, min
Polar	10 pUnit, min

Table 50. VNA Rear Panel Information, All Options

Description	Typical Performance
10 MHz Reference In	
Connector	BNC, female
Input Frequency	10 MHz \pm 10 ppm
Input Level	-15 dBm to +20 dBm
Input Impedance	200 Ω , nom.
10 MHz Reference Out	
Connector	BNC, female
Output Frequency	10 MHz \pm 1 ppm
Signal Type	Sine Wave
Output Level	+10 dBm \pm 4 dB into 50 Ω
Output Impedance	50 Ω , nominal
Harmonics	<-40 dBc, typical
External IF Inputs	
Function	Allows use of external IF signals from remote mixers, bypassing the PNA's first converters
Connectors	SMA (female); A, B, C, D, R (4-port); A, B, R1, R2 (2-port)
Input Frequency	
Normal IF path	RF < 53 MHz: IF = 826.446 KHz RF \geq 53 MHz: IF = 7.438 MHz
Narrowband IF path	IF = 10.70 MHz
Input Impedance	50 Ω
RF Damage Level	+23 dBm
DC Damage Level	5.5 VDC
0.1 dB Compression Point	
Normal IF path	-9.0 dBm at 7.438 MHz
Narrowband IF path	-17 dBm at 10.70 MHz
Pulse Inputs (IF Gates)	
Function	Internal receiver gates used for point-in-pulse and pulse-profile measurements
Connectors	15-pin mini D-sub
Input Impedance	1 K Ohm
Minimum Pulse Width, Source Modulators	33 ns
Minimum Pulse Width, Receiver Gates	20 ns
DC Damage Level	5.5 VDC
Drive Voltage	0 V (off), +3.3 V (on), nominal

Table 51. (Continued) VNA Rear Panel Information, All Options

Description	Typical Performance	
RF Pulse Modulator Input (Source Modulator)		
On/Off Ratio		
10 MHz to 3.2 GHz	-64	
3.2 GHz to 67 GHz	-80	
Pulse Period		
Minimum	33 ns	
Maximum	70 s	
Pulse Outputs		
Voltage (TTL)	High: 3.3V to 3.5V Low: <1V	
Impedance	50 Ohm	
External Test Set Driver		
Function	Used for driving remote mixers	
Connections	3.5 mm (female)	
RF Output Frequency Range	3.2 GHz to 19 GHz	
LO Output Frequency Range	1.76 GHz to 26.5 GHz	
Rear Panel LO Power¹		
	Upper Limit, Typical (dBm)	Lower Limit, Typical (dBm)
1.7 GHz to 16 GHz	5	-3
16 GHz to 21 GHz	0	-6
21 GHz to 26.5 GHz	4	-5
Rear Panel RF1/RF2 Power		
	Maximum Output Power, Typical (dBm)	
3.2 GHz to 5 GHz	+3	
5 GHz to 19 GHz	+8	
Devices Supported		
Resolutions		
Flat Panel (TFT)	1024 X 768, 800 X 600, 640 X 480	
Flat Panel (DSTN)	800 X 600, 640 X 480	
CRT Monitor	1280 X 1024, 1024 X 768, 800 X 600, 640 X 480	
Simultaneous operation of the internal and external displays is allowed, but with 640 X 480 resolution only. If you change resolution, you can only view the external display (internal display will "white out").		

¹ LO output available in full analyzer's frequency range. The power is tested only from 3.2 GHz to 26.5 GHz.

Table 52. (Continued) VNA Rear Panel Information, All Options

Description	Typical Performance
Bias Tee Inputs	
Connectors	Triaxial - for ports 1, 2, 3 and 4
Fuse	500 mA, bi-pin style
Maximum Bias Current	±200 mA with no degradation of RF specifications
Maximum Bias Voltage	±40 VDC
Trigger Inputs/Outputs	BNC(f), TTL/CMOS compatible
Test Set IO	25-pin D-Sub connector, available for external test set control
Power IO	9-pin D-Sub, female; analog and digital IO
Handler IO	36-pin parallel I/O port; all input/output signals are default set to negative logic; can be reset to positive logic via GPIB command
Pulse I/O	15-pin D connector provides access to Pulse Modulators and Generators
GPIB	Two ports - dedicated controller and dedicated talker/listener. 24-pin D-sub (Type D-24), female; compatible with IEEE-488
PCIe	Cabled PCIe x4 connector is a 4-lane slot (not currently used)
USB Ports	Two SuperSpeed USB ports (900 mA each), one USB port below LAN connector, and one USB device port. There are also four USB ports (500 mA each) on the front panel. The total current limit for all rear panel USB ports is 2.3 amps. The total current limit for all front panel USB ports is 2 amps.
LAN	10/100/1000 BaseT Ethernet, 8-pin configuration; auto selects between the data rates
VGA Video Output	15-pin mini D-Sub; Drives VGA compatible monitors
Mini DisplayPort	Miniature DisplayPort connector for connection to external displays
Line Power	
Frequency, Voltage	50/60/400 Hz for 100 to 120 VAC 50/60 Hz for 220 to 240 VAC
	Power supply is auto switching
Max	450 watts

System Dimensions and Weight

For System Dimensions and Weight, refer to the N5291A System Installation Manual, located online at <http://literature.cdn.Keysight.com/litweb/pdf/N5292-90002.pdf>.

Regulatory and Environmental Information

For Regulatory and Environmental information, refer to the PNA Series Installation and Quick Start Guide, located online at <http://literature.cdn.Keysight.com/litweb/pdf/E8356-90001.pdf>.

Measurement Throughput Summary

- Typical Cycle Time for Measurement Completion
- Cycle Time vs. IF Bandwidth
- Cycle Time vs. Number of Points
- Data Transfer Time
- Damage Level, All Options

Cycle time Includes sweep time, retrace time and band-crossing time. Analyzer display turned off with DISPLAY:ENABLE OFF. Add 21 ms for display on. Data for one trace (S₁₁) measurement. LF Auto BW off.

Table 53. Typical Cycle Time (ms) for Measurement Completion, All Models and Options

Sweep Range	IF Bandwidth ¹		Number of Points				
			201	401	1601	16001	32001
50 kHz to 100 MHz	10kHz	Uncorrected	75	141	515	4726	9243
		2-Port cal	155	285	1050	9505	18440
	1kHz	Uncorrected	306	599	2339	23000	46003
		2-Port cal	611	1200	4715	46185	91960
	100Hz	Uncorrected	2543	5085	20293	202691	405085
		2-Port cal	5120	10200	40640	405200	809800
40 GHz to 50 GHz	10kHz	Uncorrected	86	143	477	4182	8098
		2-Port cal	175	290	1000	8500	16380
	1kHz	Uncorrected	250	471	1795	17332	34414
		2-Port cal	520	962	3621	34840	69011
	100Hz	Uncorrected	1853	3669	14555	144890	289519
		2-Port cal	3720	7363	29156	289957	579200
80 GHz to 100 GHz	10kHz	Uncorrected	86	145	487	4289	8312
		2-Port cal	175	296	1000	8700	16800
	1kHz	Uncorrected	251	474	1800	17441	34628
		2-Port cal	525	974	3620	35000	69420
	100Hz	Uncorrected	1855	3666	14563	145000	289754
		2-Port cal	3742	7363	29220	290113	579700
100 GHz to 125 GHz	10kHz	Uncorrected	86	156	502	4320	8379
		2-Port cal	175	352	1044	8765	16940
	1kHz	Uncorrected	250	487	1808	17473	34695
		2-Port cal	520	998	3680	35085	69545
	100Hz	Uncorrected	1853	3682	14578	145035	289816
		2-Port cal	3742	7425	29200	290200	579762
900 Hz to 125 GHz	10kHz	Uncorrected	221	293	667	4730	9051
		2-Port cal	433	614	1360	9609	18128
	1kHz	Uncorrected	374	615	1980	17880	35555
		2-Port cal	750	1270	3996	35760	70965
	100Hz	Uncorrected	1990	3830	14757	145550	290770
		2-Port cal	4000	7720	29540	291000	581275

¹ Automatic IF reduction turned on.

Table 54. Cycle Time vs. IF Bandwidth - Typical

Applies to the Preset condition (201 points, correction off) except for the following changes:

- CF = 100 GHz
- Span = 100 MHz
- Display off

Cycle time includes sweep and retrace time.

Description		N5291A	
IF Bandwidth (Hz)	Cycle Time (ms)	Trace Noise Magnitude (dB rms)	
10 Hz	17832	0.18	
100 Hz	1824	0.18	
1 kHz	227	0.18	
10 kHz	67	0.18	
100 kHz	49	0.18	

Table 55. Cycle Time vs. Number of Points - Typical

Applies to the Preset condition (correction off) except for the following changes:

- CF = 100 GHz
- Span = 100 MHz
- Display off

Cycle time includes sweep and retrace time.

Description	IF Bandwidth (Hz)			
	100	1,000	10,000	100,000
Number of Points	Cycle Time (ms)			
51	478	72	29	25
201	1832	230	67	49
401	3652	455	125	80
1601	14476	1719	402	250
16001	144285	16582	3418	2000
32001	288242	33043	6614	3742

Table 56. Data Transfer Time (ms) - Typical

Measured with the analyzer display off.

Values will increase slightly if the analyzer display is on.

Description	Number of Points				
	201	401	1601	16,001	32,001
SCPI over GPIB (Program executed on external PC²)					
32-bit floating point	4.6	9.3	38	352	720
64-bit floating point	9.4	18.8	73.4	730	1455
ASCII	36.7	72.5	288	2882	5762
SCPI over SICAL/LAN or TCP/IP Socket¹ (Program executed in the analyzer)					
32-bit floating point	<1	<1	<1	1.2	2.4
64-bit floating point	<1	<1	<1	2.3	4.6
ASCII	2.1	4	15	148	295
COM1 (Program executed in the analyzer)					
32-bit floating point	<1	<1	<1	<1	<1
Variant type	<1	<1	1.4	12.4	25.5
DCOM over LAN1 (Program executed on external PC)					
32-bit floating point	<1	<1	<1	2.3	4.4
Variant type	<1	1.6	5.3	52	105.5

¹ Values are for real and imaginary pairs, with the analyzer display off, using Gigabit Ethernet.

N5291A System Block Diagram

NOTE

For best readability, use a color printer for printing the following graphics.

Legend

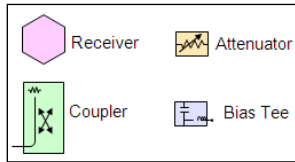

N5291A Option 201, 205 System Level Block Diagram

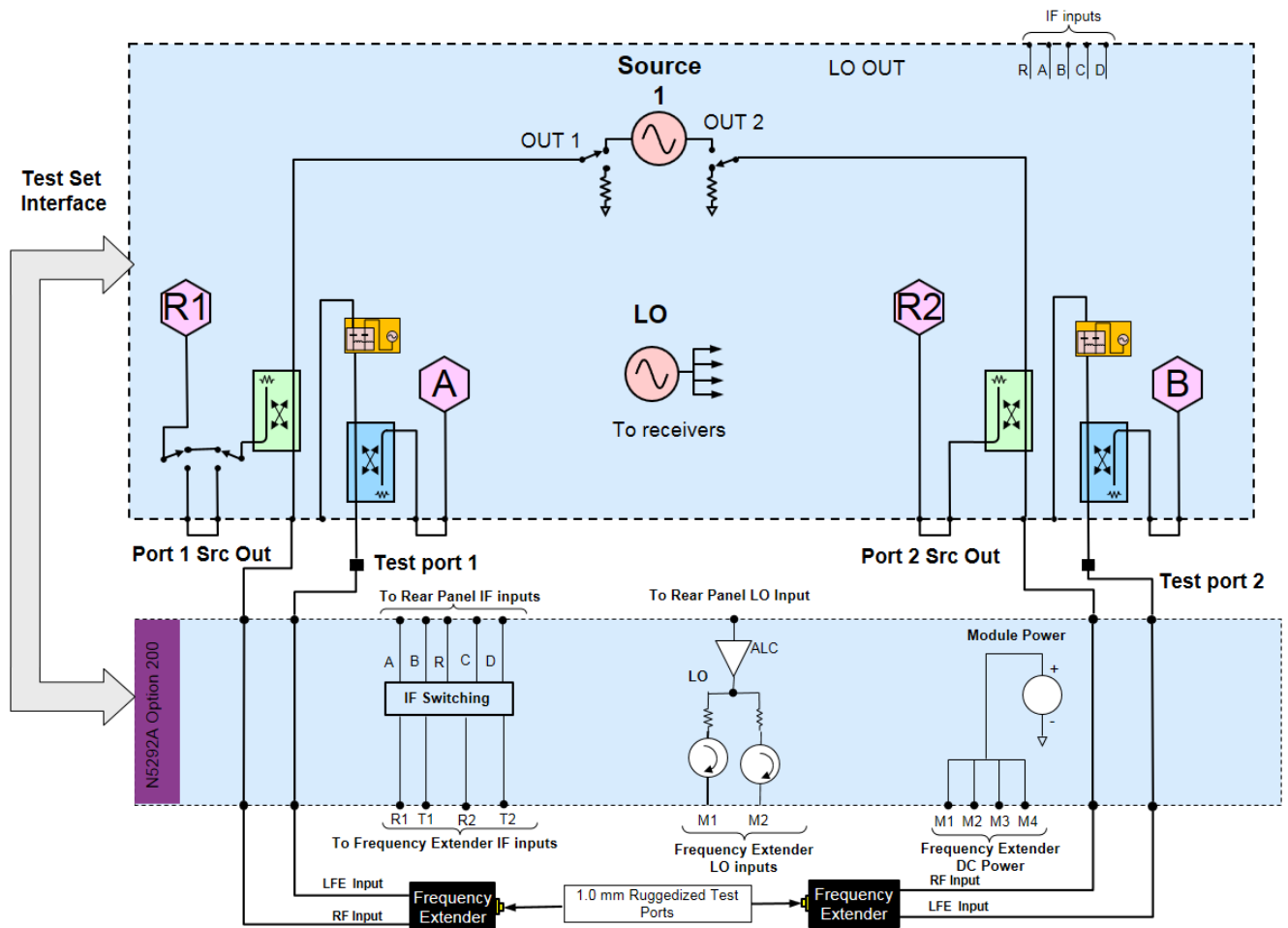

N5291A Option 202, 205 System Level Block Diagram

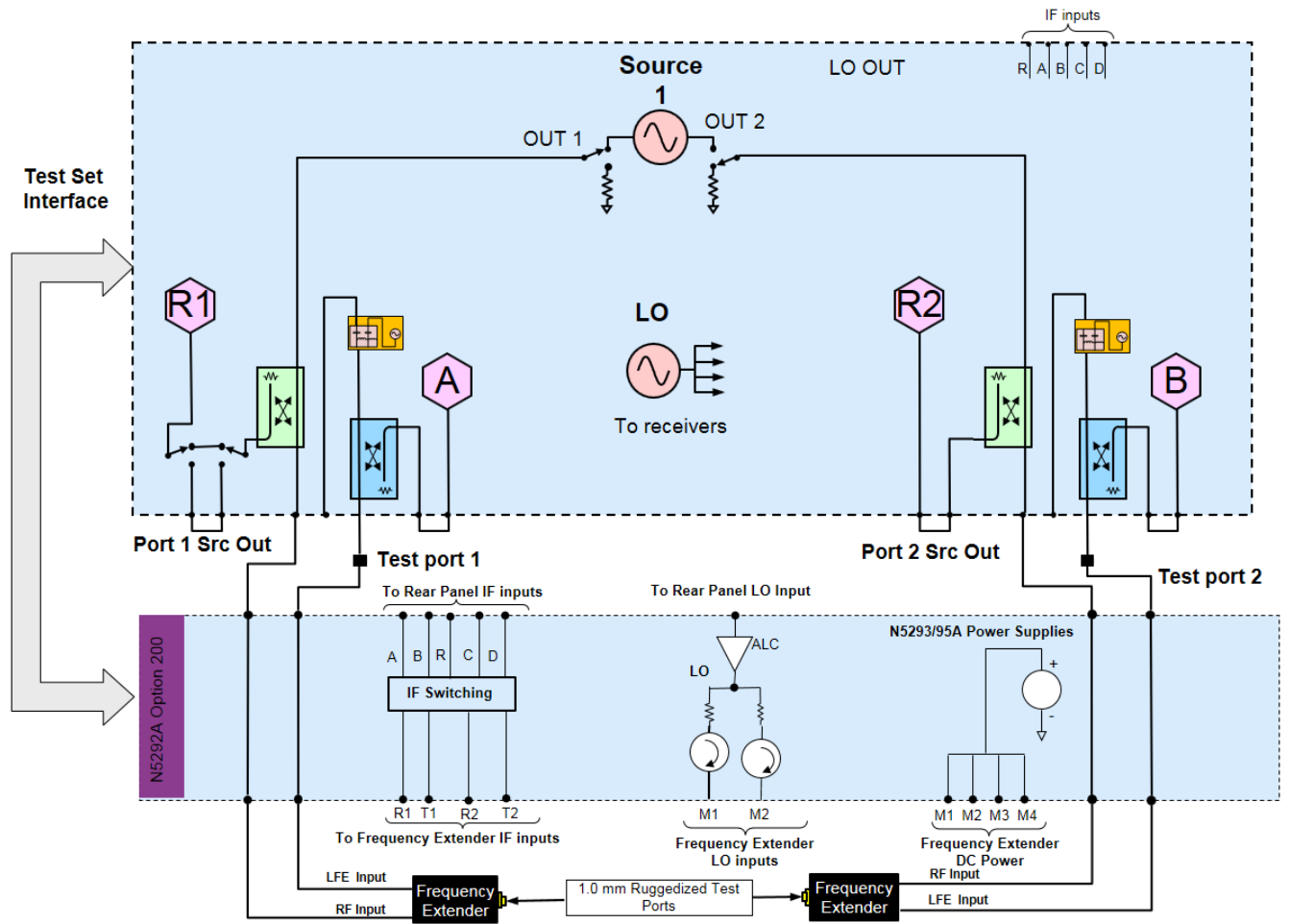

N5291A Option 401 System Level Block Diagram

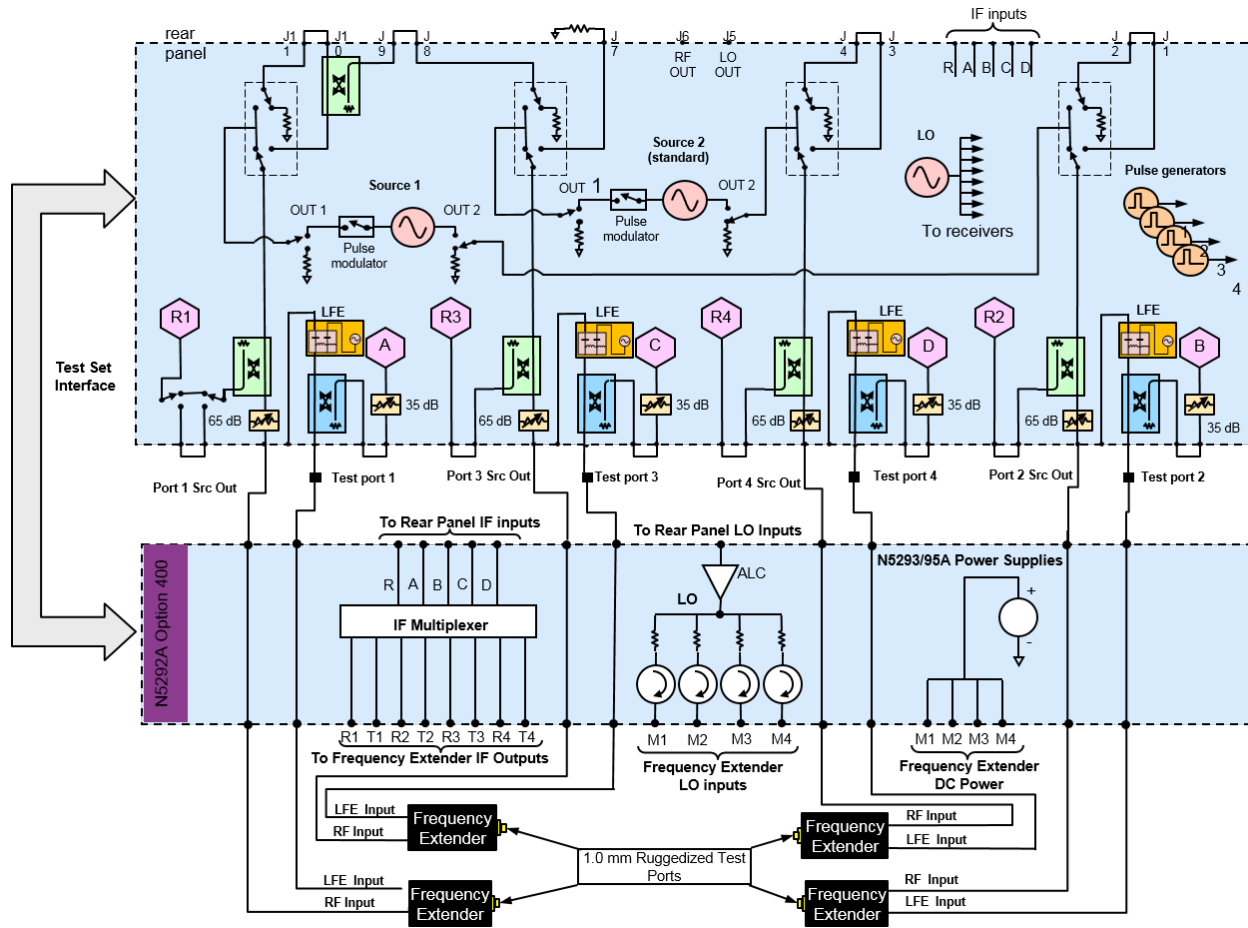

N5291A Option 402 System Level Block Diagram

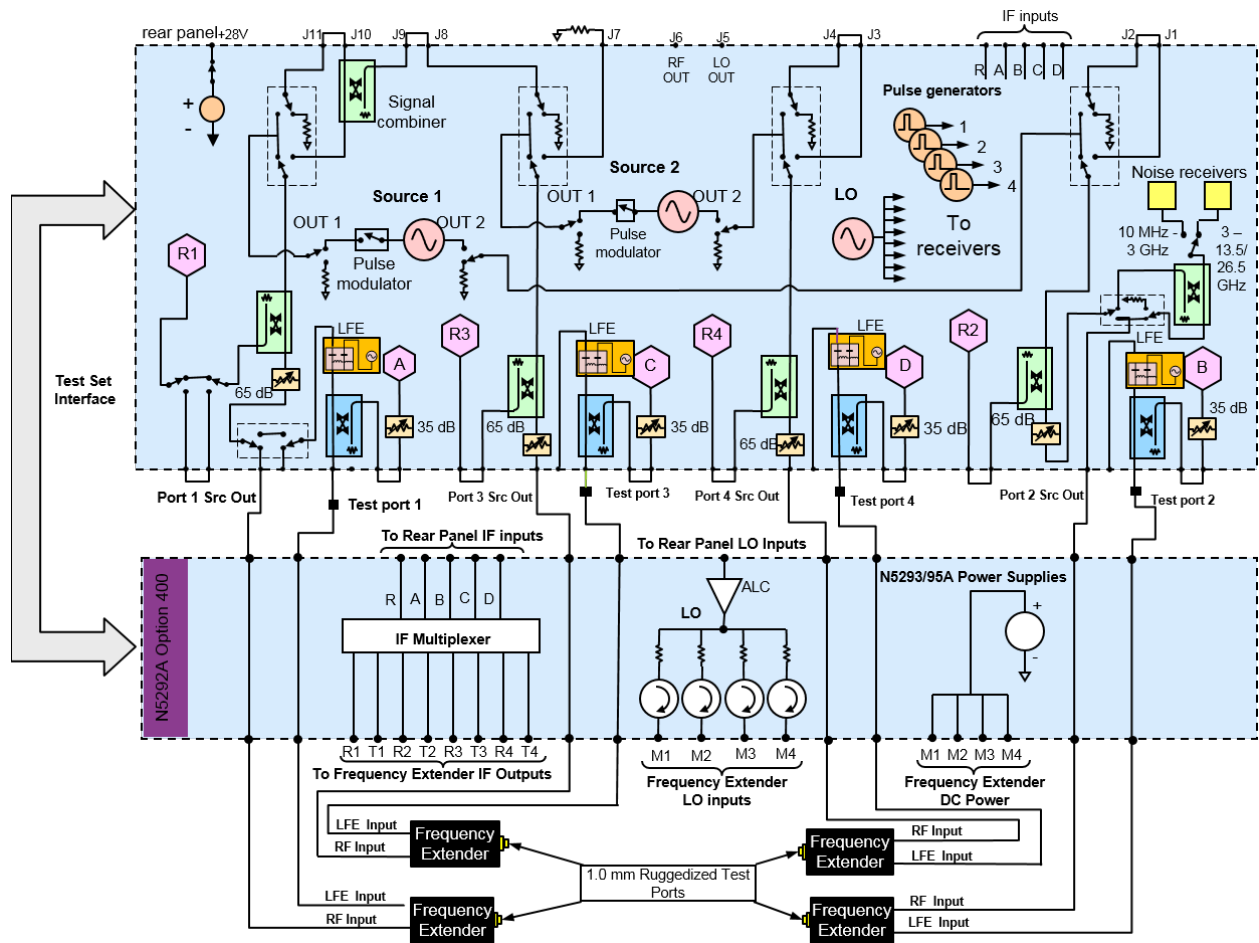

N5291A Option 403 System Level Block Diagram

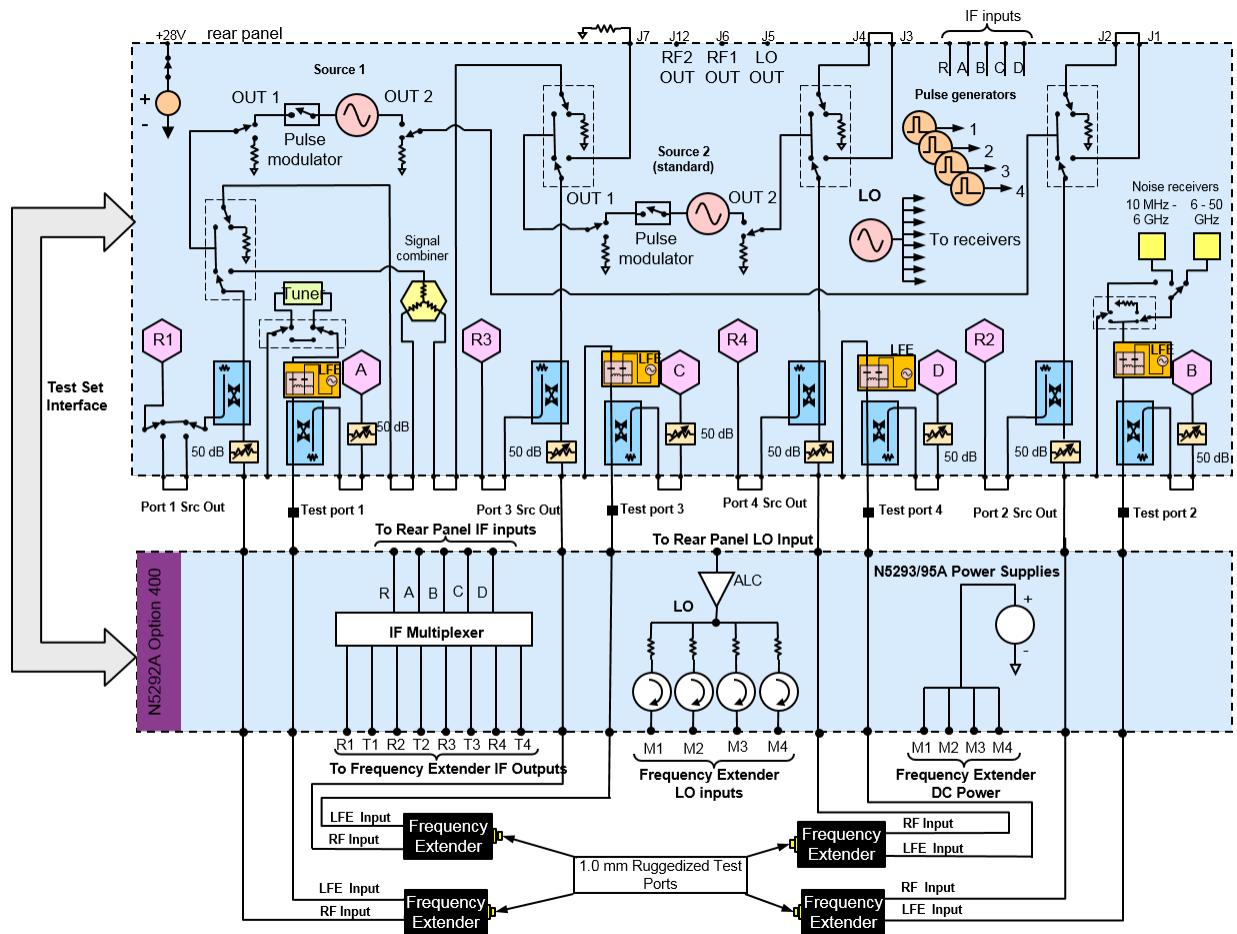



This information is subject to change without notice.
© Keysight Technologies 2017-2024
Print Date: May 16, 2024



N5291-90003